



MANY STYLES. ONE STANDARD.

BEAUTIFUL, NATURAL, AUTHENTIC, GENUINE, ORIGINAL, UNIQUE
AMERICAN, HAND-CRAFTED, CUSTOM-BUILT, DURABLE, STRONG
TOUGH, HARDY, SOUND, GRACEFUL, STOUT, STEADY, POWERFUL
PERSONAL, PRAGMATIC, USEFUL, LOVEABLE, WELL-BUILT, STURDY
WELL-CONSTRUCTED, DOWNTOWN, RELIABLE, CASUAL, ROBUST
RESPLENDENT, REMARKABLE, LIVEABLE, DEPENDABLE, MODERN
ELEGANT, REFINED, DRAMATIC, DISTINGUISHED, SOLID, CLEVER
COMFORTABLE, COZY, EASY, CONTEMPORARY, CONSERVATIVE
MODERN, TRADITIONAL, RELAXED, POLISHED, HOMEY, CURRENT
COMPELLING, CHARMING, PRACTICAL, DISARMING, INVITING
ENTICING, MOVING, UPTOWN, INSPIRED
STRIKING, INTENSE, URBAN, RUGGED
REAL, ALL-AROUND, USEFUL, ENVIED
SMART, UNEXPECTED, UNCOMPLICATED, UNCOMPROMISING
UNPRETENTIOUS, WELL-DESIGNED, EYE-CATCHING, IMPRESSIVE
STYLISH, POSH, GRAND, REGAL, WELCOMING, SIMPLE, BEAUTIFUL
NATURAL, AUTHENTIC, GENUINE, ORIGINAL, UNIQUE, AMERICAN
HAND-CRAFTED, GRAND, DURABLE, STRONG, TOUGH, HARDY
ROBUST, SOUND, SOLID, STOUT, STURDY, STEADY, POWERFUL
PRACTICAL, PERSONAL, PRAGMATIC, SMART, LOVEABLE, MODERN
WELL-BUILT, KID-FRIENDLY, RUGGED, RELIABLE, RESPLENDENT
REMARKABLE, WELL-CONSTRUCTED, DEPENDABLE, ELEGANT
REFINED, DRAMATIC, DISTINGUISHED, INSPIRED, CASUAL, CLEVER
COMFORTABLE, COZY, EASY, DISARMING, LIVEABLE, DOWNTOWN
REAL, ALL-AROUND, CAREFREE, ADMIRER, RELIABLE, ENVIED
UNEXPECTED, LOVELY, UNCOMPLICATED, UNCOMPROMISING
RELIABLE, CUSTOM-BUILT, REGAL, WELCOMING, SIMPLE, AMISH

SIMPLY AMISH

CONTENTS

Lifetime Guarantee	2	Beds	146	Rockers	358
Letter From Kevin	2	Bookcase Beds	148	Gliders	359
Caring For Your Product.....	3	Panel Beds.....	148	Style Your Own Extension Table	360
Ordering Guide	5	Live Edge Bed	160	Occasional Tables.....	362
FEATURES & OPTIONS	6	Poster Beds.....	161	Console Cabinets	394
Woods.....	6	Slat Beds.....	163	Display Cabinets	395
Surface Treatments	10	Cannonball Beds.....	165	Other	396
Standard Features.....	12	Spindle Beds	166	Hall Benches.....	396
Bedroom Features.....	14	Sleigh Beds.....	167	Hall Trees & Mirror	397
Bedroom Options	15	Convertible Cribs	168	Minibar	398
Dining Room Features.....	17	Wall Beds	169	Quilt Stand	398
Dining Room Options.....	17	Misc. Bedroom.....	170	Plant Stands	399
Leaves	18	Jewelry Armoires	171	WORK	400
Chair Features	20	Santa Fe Benches.....	172	Desks.....	400
Barstool Features	21	Clothes Hampers.....	175	Executive Desks.....	401
Work Features	22	Mirrors.....	175	Credenzas & Hutch Tops	404
Glass Options	22	Style Your Own Bedroom	180	L-Shape Desks	407
Upholstery Features.....	23	Beds	180	Smaller Desks.....	409
Upholstery Options.....	23	Inset Nightstands.....	182	Writing & Library Desks.....	410
Fabrics & Leather.....	23	Inset Dressers/Chests.....	184	B&O Railroad®/Secretary Desks.....	411
Occasional Table Option	24	Full Overlay Nightstands.....	186	Rolltop Desks	412
Hardware.....	25	Full Overlay Dressers/Chests	188	Laptop Secretary Desks.....	413
SLEEP	30	EAT	190	Laptop Cabinets	414
Aspen	30	Aspen	190	Style Your Own Writing Desks	416
Auburn Bay.....	36	Auburn Bay.....	194	Style Your Own Modular Office	418
B&O Railroad®	40	B&O Railroad®	196	Ordering Guide	419
Beaumont.....	44	Crawford	200	Styles	420
Belvedere.....	46	Grant.....	202	Base Units	421
Braden	48	Hamptons.....	204	Corner Units.....	423
Classic	50	Ironwood	206	Top Units	424
Colburn.....	54	Justine	208	Bridge Units	426
Crawford	56	Live Edge.....	210	Bookcases & TV Units	427
Dovetail.....	58	Loft.....	212	Wall Beds	428
East Village.....	60	MäRyan	216	Entire Office Units	429
Elroy.....	62	M°Coy.....	220	Desk Chairs	432
Empire	64	Montauk.....	222	Organization.....	434
Frisco	66	Montgomery	224	Bookcases	434
Garrett.....	68	Parkdale.....	226	File Cabinets.....	442
Georgia.....	70	Riverview	228	EXPRESS/QUICKSHIP	444
Grant.....	72	Sheffield	230	Sleep	444
Haley.....	74	Shenandoah.....	232	Aspen	444
Hamptons.....	76	Wildwood	236	Garrett.....	446
Homestead	80	Misc. Tables	238	Loft.....	448
Imperial.....	84	Style Your Own Tables	240	Shenandoah.....	450
Ironwood	86	Studio Leg Tables.....	240	San Miguel.....	452
Justine	88	Studio Pedestal Tables.....	242	M°Coy.....	454
Kodiak	92	Leg Tables.....	244	Eat	456
Loft.....	94	Pedestal Tables.....	248	Shenandoah.....	456
Louis Philippe	98	Double Pedestal Tables	252	B&O Railroad®	460
MäRyan	100	Trestle Tables	256	Loft.....	462
M°Coy.....	104	Trestle II Tables	260	Montauk	464
Monarch	108	Storage	264	Sheffield.....	466
Montauk.....	110	Dining Cabinets.....	272	Aspen	468
Montgomery	112	Hutches	275	Auburn Bay.....	469
Naomi.....	114	Style Your Own Dining Cabinets	282	Albany	470
Parkdale.....	116	Inset.....	282	Parkdale.....	471
Prairie Mission	118	Full Overlay	284	Live	472
Royal Mission	122	Chairs	286	TV Stands	472
San Miguel.....	124	Barstools	302	Sofa/Dining Table	473
Savannah	126	Benches	314	Occasional Tables.....	474
Shaker	130	LIVE	322	Greenville Incognito Coffee Table	474
Sheffield	134	Entertainment.....	322	Recliners	478
Shenandoah.....	136	Style Your Own Media Units.....	344	Glider.....	478
Sheridan	140	Style Your Own Console Cabinet.....	346	Rockers	478
Sophia	142	Seating	348	Work.....	480
Wildwood	144	Easy Chairs, Recliners, Loveseats, and Sofas	350	Desk Chairs/Writing Desks.....	480

LIFETIME GUARANTEE

Our promise is simple. If your furniture fails during normal household use in the lifetime of the original owner due to problems in either the workmanship or material, we'll repair or replace it for free, with the following exceptions:

Cabinet lights, as well as all finishes, fabrics and leather* are warranted for one year; the moving parts in our wall beds, desk chairs and recliners are warranted for three years; and, while we fully appreciate the beauty of unfinished furniture, we are unable to extend our warranty to any furniture that's not protected by our exceptional finish.

**Does not apply to damage caused by others or any defects resulting from abuse, alterations or accidents.*

This warranty applies only to normal household use determined solely at the discretion of the manufacturer. Liability for consequential property damage is excluded from this warranty.

Once a warranty issue is confirmed by Simply Amish, it is the responsibility of the original owner to return the piece to their nearest Simply Amish dealer. Simply Amish is not responsible for any transportation costs incurred by the original owner to return the piece to the nearest Simply Amish dealer or redelivery from Simply Amish dealer to the original owner. There is no charge for the cost of Simply Amish picking up the piece from Simply Amish dealer, repairing warranty issue, and returning to Simply Amish dealer. Simply Amish is sold through independently owned dealers, and Simply Amish has no control over their policy for picking up warranty related items at residences or businesses. This Lifetime Guarantee for workmanship or material cannot be transferred beyond the original owner.

If a Simply Amish product has issues not covered under our Lifetime Guarantee, our Returns department will assess the issue, provide a written estimate for the repair, and if work is approved by Simply Amish dealer, pick-up and redeliver the piece needing repair, to the Simply Amish dealer. Under no circumstances will Simply Amish pick up and redeliver to furniture owner. All transportation costs associated with picking up the product from owner's residence and returning to Simply Amish dealer, and redelivery from Simply Amish dealer to owner's residence is the purview of the owner and dealer.

Items for non-residential use are covered under a separate three-year limited warranty and cover items if they fail due to workmanship or materials. To qualify for this warranty, we need to know that the items ordered are for non-residential use. Some items ordered for non-residential use will not qualify for either non-residential use or residential use warranties.



WELCOME TO OUR FAMILY

Let me be the first to welcome you to the Simply Amish family. We're close, in every sense of the word. Most of our craftsmen live in Central Illinois, where my family has lived for generations. We do more than sleep on this furniture. We dream about it. We don't just eat at it, we eat it up. We entertain with it, while designing and building it entertains us. I guess what I'm trying to say is that this furniture is more than our livelihood. It's our past, our future, and our passion.

That's why we sand and stain every bit of each piece entirely by hand. Our solid drawers extend fully, close softly, and are hand finished with dovetail joints in both the front and the back — so they will work and look the same generations from now. Our tables are sealed on the bottom to prevent warping, and like a work of art, every builder signs whatever he has crafted.

At Simply Amish, quality is first and foremost. It has to be. That's how we can offer you the guarantee shown on the left.

We know that you will love Simply Amish's fine, solid-wood furniture as much as we do once you bring it into your home. Again, welcome to the family.

A handwritten signature in black ink that reads "Kevin Kauffman". The signature is fluid and cursive, with the first name being the most prominent.

Kevin Kauffman, Co-founder and President

So how do I keep this beautiful piece looking great for many years?

YOU DON'T HAVE TO BE OBSESSIVE. YOU JUST HAVE TO CARE.

This is how we take care of the solid-wood furniture in our homes:

TRUST We know how much effort has gone into using the best products available to ensure a finish that will protect the wood craftsmanship of every piece. The finish we use is a post-catalyzed varnish, or conversion varnish. One of the many superior aspects of our varnish is that it is non-yellowing — unlike lacquer. Like a new car, baby it at your house for the first 30 days — giving the finish time to cure.

PLAY DEFENSE We use placemats under rough plates, trivets to protect from the heat of serving dishes, and a tablecloth when we are serving large groups. Outside the kitchen, we don't use coasters. We just wipe off any condensation when we're done. We are mindful that any piece used as a work surface could be permanently etched if someone is pressing too hard with a pen or pencil, and pad these surfaces accordingly. We also try not to leave something sitting on our solid-wood furniture for a long time if that piece gets a lot of sun. Some woods, like cherry, tend to change color over time when exposed to light.

STAY COMFY Just like us, solid wood furniture is always breathing. Very high levels of humidity can lead to warping and swelling, while very dry air may cause shrinking or cracking. If we are not comfortable with the humidity level, neither are our Simply Amish pieces. We maintain the level of humidity in our homes at around 35 percent.

DON'T WORRY Just wipe. Things get spilled on our furniture. It happens. We just wipe it off as soon as we are aware of it. The finish does the work. Only prolonged exposure to moisture will damage the furniture.

HOLD THE CHEMS We've added Aristo Shield protective polish, available from your Simply Amish dealer. Aristo Shield dusts, cleans, and helps protect the surface from scratching and marring. It removes smudges and fingerprints. When used routinely, its anti-static additive reduces dust build-up. Aristo Shield is available in dark, which will work on most colors, including natural.

PLEASE DO NOT USE ON WHITE COLORS.

- Water-Based
- No Bleach
- No Harsh Solvents
- Does Not Affect the Sheen
- Can Be Re-Coated

WARNING: This product contains a chemical known to the state of California to cause cancer or birth defects, or other reproductive harm.



Aristo Shield, Dark
SA-FNAOS-CASE



YOUR FURNITURE. YOUR WAY.

When we say “custom-built” we mean it.

At Simply Amish, you choose the wood, the stain and every other element that goes into making your selection unique. We don't start construction until we receive your order. From that point forward, your furniture is tracked by your name, so that each craftsman knows the person they're building for. And in the rare event that your furniture needs warranty work, all you have to do is get the item back to one of our authorized dealers and we will take it from there to make sure the issue is resolved.

To learn more about Simply Amish and the unique way we build every piece of furniture, visit our website, SimplyAmish.com, where you will find an extensive collection of short videos covering our options, features, and benefits.

SimplyAmish.com/videos

MANY STYLES. ONE STANDARD.

Simply Amish isn't a style. It's a standard of excellence — desired by many and practiced by a rare few. It's in the fine details of solid hardwood drawers, finished inside and out to protect delicate clothing from damage. It's in the skill of genuine Simply Amish craftsmen, faithfully passed down from one generation to the next. But most of all, it's in the beauty of America's richest hardwoods, handcrafted in a thousand different styles — from country cabinets that are the hallmark of Americana, to contemporary designs that say, “Move over, Herman Miller, Simply Amish is in the house.”

With Simply Amish furniture, you're the ultimate designer. We make recommendations, but you make the call — choosing the wood, stain and hardware that make your selection complete. We'll even work with you beyond the options you see in this catalog, giving you the ability to create a wooden work of art that's truly one of a kind.

The Simply Amish Custom Design Center. When you don't know where to start, start here. See your nearest Simply Amish dealer for a firsthand look at the various wood, stain, fabric and hardware options available for your selection.

Kiosk Design Center — 41" w x 16" d x 90" h

Wall Design Center — 100" w x 16" d x 92" h



MANY STYLES.
ONE STANDARD.

PLACE YOUR ORDER. IN ANY ORDER YOU WANT.

While the following steps offer a simple way to complete the ordering process, you're welcome to mix things up. Start with your choice of wood, or build your order around an amazing piece of fabric. As long as we get the information we need, we'll make sure you get what you want.

1

SELECT YOUR FURNITURE.

Your furniture. Your house. Your choice. Choose from thousands of catalog pieces or design your own. Custom building ensures that everyone gets the perfect piece in the perfect style — their own.

2

SELECT YOUR WOOD & FINISH.

And by "wood," we mean real wood. Not plastic or particleboard. See your nearest Simply Amish showroom for actual samples to help you pick the right wood and finish.

Note: Some colors can add 5% or 10%. Please refer to the samples or the Simply Amish website — SimplyAmish.com

3

SELECT YOUR HARDWARE.

Nickel, brass, copper, iron, or wood. Burnished, brushed, polished, hammered, blackened or weathered. So simple, we should call it "easyware."

4

SELECT YOUR FABRIC.

Looking for something to complement your new furniture? Choose from our great selection of designer fabrics or bring us your own. And then invite some people over.

Note: Customer supplied (COM) fabric yardages are estimated on product pages. Since fabric repeats can vary, if there's a question, please call for specifics. Unused COM fabric will not be returned. Items purchased with COM fabric are priced as grade 3.

5

PLACE YOUR ORDER.

Our staff can guide you through the order placement process. Remember, this is custom, and our artists are pretty particular about having the correct information to work with.



The Express Option. For your convenience, many of our most popular selections are available in select woods and stains, ready for immediate shipment. Just look for this Express icon or view our entire Express selection.

Hardwoods and Softwoods

There are two major types of wood used in furniture manufacturing — hardwoods and softwoods. Softwoods are less durable than hardwoods but more plentiful, partly because they tend to grow at a much faster rate. They're also less expensive, providing a preferable alternative to particle or fiberboard. Common softwoods include pine, fir, spruce and cedar.

Known for their strength and durability, hardwoods are usually found in higher-quality furniture. At Simply Amish, we only use northern, slow-growth hardwood, chosen for the greater density typical of wood grown in colder climates. Grown and harvested in the USA, the use of these beautiful hardwoods helps support the local economy without adding to the problem of rainforest depletion. Choose from red oak, white oak, soft maple, hard maple, cherry, hickory and walnut.

Layered For Strength

There are some cases where solid wood panels aren't practical, simply because the seasonal contraction and expansion would destroy the integrity of the joints. In these cases, we still use hardwood — just in a plywood form, layering multiple panels in a cross-grain build for maximum structural stability. This wood is most typically used in shelves, cabinet backs, and on cabinet sides without a flat or raised panel.

Distinguishing Finish From Wood

Sometimes things are not as they appear. For example, "cherry finish" may mean only that a piece of furniture has a reddish stain or a finish similar to cherry wood, even though it contains no real cherry at all. We don't do that. If you're in the market for solid hardwood furniture, ask for it by name.

Quartersawing Technique

Quartersawing is simply a cutting technique used to achieve a finished appearance different from the typical flatsawing technique. Quartersawing involves cutting a log into quarters, then cutting boards alternately from the two flat sides of each quarter. This process produces a combination of parallel line patterns and varied figuring that many connoisseurs of fine wood furniture find appealing. Oak cut in this manner is commonly called "tiger oak" and is traditionally found in the Arts & Crafts style of furniture.

Solid wood expands and contracts. Therefore, measurements may vary $\pm 0.25"$.

A WORD ABOUT WOOD.

There are varying degrees of quality when it comes to furniture production. Some use particleboard in places where they think you won't look — and cardboard in places where they just don't care. But that's not the Simply Amish way. At Simply Amish, we use only the finest northern hardwoods, raised to perfection and slowly kiln-dried to prevent splitting and provide years of reliable use.

CHARACTER GRADE WOOD.

Character cherry and quartersawn oak have all the characteristics of the premium grades, plus a few more. Harvested from the same tree as its premium counterpart, character wood is simply a different grade — one with more knots, some small cracks, variations in the grain, and more, well, character.

Character Wood with FILLED KNOTS is STANDARD on table tops, case goods tops, desk tops, chair seats, and bench seats.

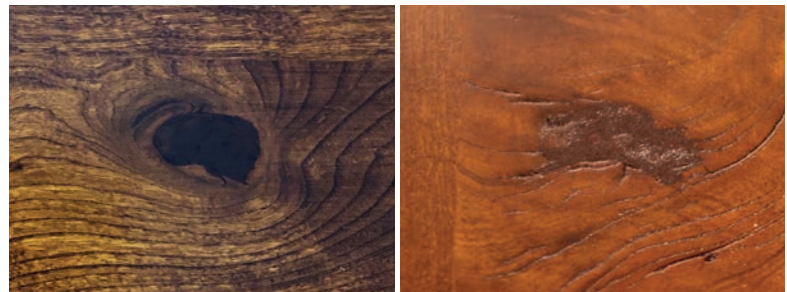

Character Wood will have OPEN KNOTS on the rest of the piece.



SELECT FROM 7 POPULAR HARDWOOD CHOICES.

Red Oak

Quercus Rubra

Red oak is a very popular hardwood, chosen for its traditional, coarse-textured look, as well as its excellent durability and strength. It accepts stain consistently and wears very well over time, making red oak a good choice for furniture that will see heavy everyday use. Natural color varies from yellow to pale brown, often with a light reddish tinge.



White Oak

Quercus Alba

White oak — much like red oak — is hard and strong, providing outstanding wear-resistance. It has a medium-coarse to coarse texture and varies in color from light tan to nearly white or light grey. At Simply Amish, we use quartersawn white oak for a unique aesthetic appeal.



Soft Maple

Acer Rubrum
A. Saccharinum

Soft maple, sometimes called brown maple, is a straight-grained, fine-textured wood. And despite its confusing name, it's actually a hardwood. Derived from red or silver maple trees, soft maple has roughly the same density as cherry, with colors usually ranging from light cream to pale brown with occasional dark streaks.



Hard Maple

Acer Saccharum
A. Nigrum

Hard maple, or rock maple, comes from sugar or black maple trees. It's a tough, moderately heavy wood with a fine and uniform texture. Hard maple finishes very smoothly and is extremely durable. Commonly seen with no stain, its natural color varies from nearly white to light tan, with an occasional reddish tinge.



Cherry

Prunus Serotina

Cherry is a dense, even-grained wood, widely considered to be the finest of the fruitwoods. It is prized for its beauty and considered an excellent choice for both formal and casual applications. Natural coloration varies from a light cream to a dark reddish brown; however, cherry can darken considerably with age, developing a deep, rich patina over the course of several years.



Hickory

Carya Spp.

Hickory is a close-grained wood that's often nearly white in color. It's also one of the hardest, heaviest and strongest woods found in the United States. Because of its flexibility and resilience, hickory is commonly used in the construction of chairs and other bentwood furniture.



Walnut

Juglans Nigra

Walnut is a dense wood, ranging in color from light- to deep-chocolate brown. The black walnut tree produces one of the finest cabinet woods. Slow-growing and highly desired, walnut is more expensive than many other woods.

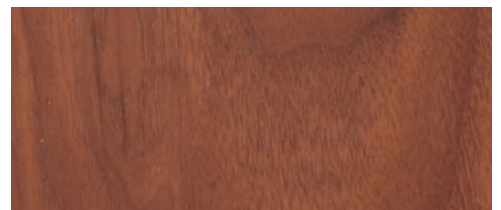

Unless otherwise stated, our furniture is available in all seven of our popular wood selections. See item descriptions for any limitations on wood choices.



BRING OUT THE NATURAL GRAIN BY ADDING DEPTH AND COLOR

Giving your home a perfect color palette goes beyond paint. From a deep rich Mocha Nut to a bright golden Autumn Haze, with over 170 wood/stain combinations, Simply Amish has the look you desire.

PREMIUM STAINS

The majority of our colors are standard wiping stains and are included in the price of the item. A few of our colors are premium, multi-step colors and require a 5% to 10% up charge, depending on the color.

OCS STAINS

Although we prefer to use our own specially formulated stains, we do also work with the OCS approved line of stains. Charges may apply, depending on the color.



Pale Moon
289

STAIN MATCHING – OPTION

Stain matching is not an easy thing to do. The wood itself will vary in color and even change color over time making stain matching more difficult and time consuming on a new piece of wood. Stain matching requires a custom quote.

add 5% (plus match fee)

BENJAMIN MOORE PAINT MATCHING – OPTION

We match Benjamin Moore paints. There is a one-time Paint Match Fee. We will keep your color on file for one year. add 10% (plus match fee) **JMOBM**

TWO-TONE – OPTION

We offer 2-tone options on most of our product. In most cases, it will be the “removable” portion of the item that can be made a different color — chair seats, table tops, case tops, doors, or door fronts. Mixing two different woods is also available as an option for most of our product. See our price list for availability.





FIRST ACROSS THE FINISH LINE You never know what some drip will drop. That's why we protect all of your furniture with a sealant that makes it practically impervious to water, nail polish remover, and alcohol. Of course, being Amish, we're just guessing on the last two.

POST-CATALYZED VARNISH – STANDARD

At Simply Amish, we believe that if you're going to build a piece of furniture that will last generations, then that furniture deserves to have the best finish possible. We use a post-catalyzed varnish (or conversion varnish), which is one of the best finishes in the industry.

It's a lot more work to use a post-catalyzed varnish, but it's worth the extra effort. Post-catalyzed varnish has a lot of advantages over lacquer. It has a much higher solid content, and is thicker, more durable, and more flexible than lacquer. It won't crack or shatter as the solid wood expands and contracts, which is a natural occurrence with solid wood.



INDOOR POLYURETHANE FINISH – OPTION

Our indoor polyurethane is the toughest finish available on any hardwood furniture and comes standard in 20° sheen. Polyurethane finish is not available in other sheens.

add 10% **JMOPOLY** Indoor Polyurethane Finish



LOWER SHEEN – OPTION

Unless otherwise specified, our furniture is finished with our standard 35° sheen varnish. We also offer two lower sheens.

add 5% **JM020DS** 20 Degree Sheen
 add 5% **JM05DS** 5 Degree Sheen (matte)



TOUCH-UP & REPAIR KITS

A fast and easy way to touch up minor scratches or damage for most of our stains. See the price list for available colors, or order online at SimplyAmish.com.





SURFACE TREATMENTS If you like options, then you'll love us! In all, we offer more than 170 combinations of woods and stains, along with additional surface treatments like distressing, hand-scraping, and wire brushing, which helps to create the subtle look of a family treasure gently worn by time.



WIRE BRUSHED – OPTION

Distressing with a wire brush reveals the unique wood grain of your piece, highlighting the enchantment obtained from synthesizing weathered wood with refined design. When you order the Wire Brushed Option, we apply our 5° sheen varnish.

Available on all woods.

Wire Brushed charges add 15% **JMOWB**



ROUGH SAWN – OPTION

Rough Sawn typically produces two surfaces with more Rough Sawn marks than other parts of the board. As a result, not every part of the surface of a board will exhibit remnants of the technique.

Available on all woods and on most items. The treatment will be applied to flat surfaces. Live Edge tops require a custom quote. Not available on chairs.

Rough Sawn charges add 10% **JMORS**

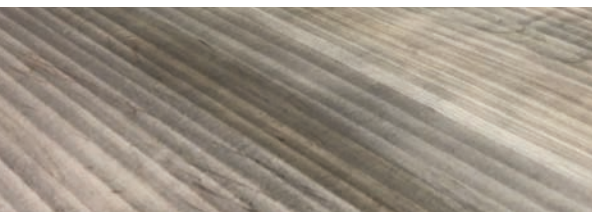

HAND-SCRAPED – OPTION

As the name implies, this scalloped, wavy look on wood is laboriously arrived at by a craftsman's expert hands and finely calibrated tools.

Available on top surfaces only. Not available on Oak, Quartersawn White Oak or Hickory.

Hand-Scraping charges add 20% **JMOHS**



RECLAIMED HARDWOOD OPTION – OPTION

Preserve the past with this great new wood option. Rescued from old buildings, barns, and rural structures, this unique wood is hand picked for its genuine antique look and feel.

Not available on chairs and barstools. Limited to flat surfaces.

JMORECLAIM

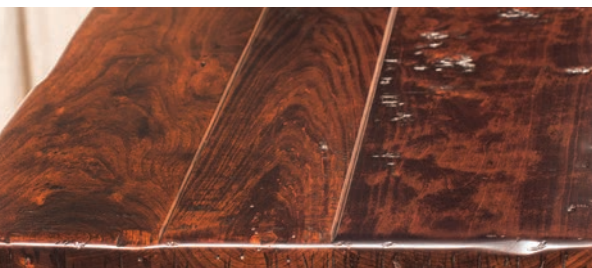

PLANK TOP – OPTION

Our plank width wood is glued up like a normal top, and then we cut a groove in the top of each glue joint, the length of the top, to accentuate the plank. This, in essence, eliminates the contraction and expansion of each individual board that comes with plank tops using tongue and groove joinery.

Available on all woods; top surfaces only.

Plank Top charges add 10% **JMOPLANK**



OLDE WORLD Our Olde World aging process invigorates our furniture, revealing facets that normally take a hundred years to create. Don't worry about the first ding. It's the least we can do. Our craftsmen painstakingly create an aged appearance into the wood that will arouse your senses, without compromising the structural integrity of your furniture.

OLDE WORLD A-LEVEL AGING – OPTION

A-level aging includes hand planing, which creates an uneven surface and various other textures unique to each piece of wood, producing remarkable character with worm holes, faux cracks, tasteful dents, and time worn edges.

Available on all woods.

Olde World "A" level charges add 20% **OW-A**



OLDE WORLD B-LEVEL AGING – OPTION

B-level aging is a less obtrusive aging process. Level B includes all of level A with the exception of hand planing. The surface remains level, but the process still features worm holes, faux cracks, tasteful dents and time worn edges.

Available on all woods.

Olde World "B" level charges add 15% **OW-B**



OLDE WORLD C-LEVEL AGING – OPTION

C-level aging consists only of a few time worn edges, and on the appropriate opaque colors will also feature our "rub through" which mimics an older finish showing through the paint in the age worn areas of each item.

Available on all woods.

Olde World "C" level charges add 10% **OW-C**



Wax Option. When requested, we will wax the item using a power buffer to buff off all the excess wax leaving a special aged feel to the finish. Please note this wax process doesn't add additional protection or sheen to the furniture and finish, it's all about the feel.

add 5% **OW-WAX**

All upcharges are to be added to the base price of the item, in the wood of your choice. You don't need to add the markup to any additional options. Olde World distressing is available with all woods and stains. Select stains require an additional 5% or 10% charge.



STANDARD FEATURES All furniture is not created equal. At Simply Amish, we pride ourselves on the use of premium-quality hardware, construction techniques, and joinery in the production of all our furniture.



BLUM SMARTSLIDES – STANDARD

Exceptional drawers require exceptional hardware. That's why our drawers feature heavy-duty slides that allow the drawer to fully extend. The slides are fully enclosed and mounted from below, creating an unobstructed view of our solid dovetail construction. SmartSlides also feature an advanced mechanism that prevents slamming by soft-closing each drawer when it reaches a few inches from the cabinet.



SOFT-CLOSE HINGES – STANDARD

Like our SmartSlides, our titanium finish, soft-close hinges provide a smooth, silent close...no matter how hard the door is closed. Our concealed, soft-close hinges now come standard on all cabinet doors.



HIGH-QUALITY DRAWER BOXES – STANDARD

Drawers take a lot of abuse as you open and close them almost daily. All of our drawer boxes are constructed of 5/8" thick solid hardwood (we use maple drawers in furniture constructed in cherry, maple and walnut and we use oak drawers in the rest of the wood species). Our drawer boxes are dovetailed front and back and the drawer bottom is inserted into a groove to form a captive bottom after all 5 pieces are glued and compressed together. Each drawer is then sanded and finished smooth with our varnish to preserve its natural beauty and ensure a lifetime of worry-free operation.

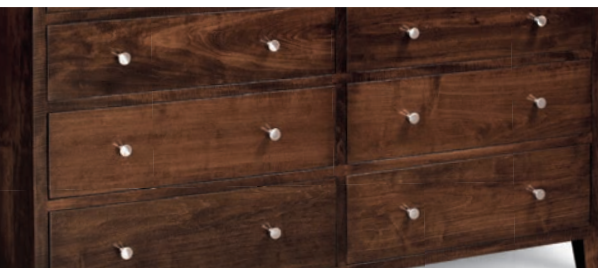

ONE-PIECE DRAWER FRONTS – STANDARD

Our drawer fronts are one piece with no glue lines up to 8½" (Excludes character cherry). We also finish, and then seal the front prior to attaching it to the drawer box.

LUXURIOUS FINISH – STANDARD

Seven Northern Hardwoods and many great color selections, afford you over 170 possible wood and stain combinations to choose from.

Our dining table tops get three coats of post-catalyzed varnish, making them resistant to water, alcohol, and nail polish. The undersides of our dining tables are finished to prevent snags on clothing and to seal the wood to prevent warping and cracking.



SEALED EDGE GRAIN – STANDARD

We seal the end grain with a special sealant to eliminate moisture transfer and help prevent warping.



DADO JOINERY – STANDARD

For a stronger, long-lasting structure.



DOWEL JOINERY – STANDARD

To ensure structural integrity for the life of your product, we use engineered dowels in our casegood frames that absorb glue better. Screws are used only as secondary support.



MORTISE & TENON JOINERY – STANDARD

Some of our pieces employ mortise and tenon joinery. Screws are used only as secondary support.



YOUR FURNITURE. YOUR WAY.

When we say “custom-built” we mean it. At Simply Amish, you choose the wood, the stain and every other element that goes into making your selection unique. We don’t start construction until we receive your order. From that point forward, your furniture is tracked by your name, so that each craftsman knows the person they’re building for. And in the rare event that your furniture needs warranty work, all you have to do is get the item back to one of our authorized dealers and we will take it from there to make sure the issue is resolved.





BEDROOM FEATURES All furniture is not created equal. At Simply Amish, we pride ourselves on the use of premium-quality hardware, construction techniques, and joinery in the production of all our furniture.



BLUM SMARTSLIDES – STANDARD

Exceptional drawers require exceptional hardware. That's why our drawers feature heavy-duty slides that allow the drawer to fully extend. The slides are fully enclosed and mounted from below, creating an unobstructed view of our solid dovetail construction. SmartSlides also feature an advanced mechanism that prevents slamming by soft-closing each drawer when it reaches a few inches from the cabinet.



SOFT-CLOSE HINGES – STANDARD

Like our SmartSlides, our titanium finish, soft-close hinges provide a smooth, silent close... no matter how hard the door is closed. Our concealed, soft-close hinges now come standard on all cabinet doors.



HIGH-QUALITY DRAWER BOXES – STANDARD

Drawers take a lot of abuse as you open and close them almost daily. All of our drawer boxes are constructed of 5/8" thick solid hardwood (we use maple drawers in furniture constructed in cherry, maple and walnut and we use oak drawers in the rest of the wood species). Our drawer boxes are dovetailed front and back and the drawer bottom is inserted into a groove to form a captive bottom after all 5 pieces are glued and compressed together. Each drawer is then sanded and finished smooth with our varnish to preserve its natural beauty and ensure a lifetime of worry-free operation.



HIGH-QUALITY BED HARDWARE – STANDARD

Our wooden bed frames connect with non-glued dowels and a heavy steel bolt anchored by an engineered nut. We supply a wrench for tightening the bolts should they loosen. Angle Iron runs the length of the rails to strengthen the rail and support the slats.



FIVE SLATS – STANDARD

Each of our beds come with five wooden slats to support your mattress foundation. On queen beds three of the slats will have additional support feet. On king and California king beds all 5 slats have additional support feet. These slats are supported on the side rails by the angle iron.

BEDROOM OPTIONS

UNDER-BED STORAGE — OPTION

Due to the popular nature of under-bed storage, we have carefully designed ours so it can be added to almost any of our beds. Please check specific beds for information on which beds can accept our under-bed storage.

Under-bed storage is sold separately from the headboard and footboard. The desired bed must be purchased as well. If under-bed storage is ordered to be used on a headboard with wood frame, the footboard height is increased to accommodate the drawer units.



WOOD FRAME — OPTION

No Footboard, No Problem. For those of you who like to hang your feet off the bed we have a solution for you. Most of our beds can be ordered with a wood frame which will eliminate the footboard giving you ample room to stretch out.



COMPLETE WOOD FRAME BED — OPTION

Not looking for a headboard or footboard, but want a sturdy bed that will last a lifetime? Look no further...

Headboard: 14" h; Footboard: 14" h

CA King	76½" w x 90" d	SBWFR-15W1
King	80½" w x 86" d	SBWFR-15W2
Queen	64½" w x 86" d	SBWFR-15W3
Full	58½" w x 82" d	SBWFR-15W4
Twin	43½" w x 82" d	SBWFR-15W5



ROLLED SLATS — OPTION

Looking to lower the height of your mattress? Order our rolled slats option and you will receive everything you need to put your mattress directly onto any of our beds, eliminating the need for traditional box springs. When selecting this option, you may consider altering the height of your headboard, depending on the style.

Side rails on standard Simply Amish beds have an 8" clearance. With slats installed, your foundation will be just 9" off the floor. 2" gaps between the wooden slats.

KAORS-99 *Slats only. Does not include bed frame.*



HEADBOARD ONLY — OPTION

When a headboard is all you want, it's all you'll need to order. Just select the style of your choice and order the headboard only. There are also options available to customize the height.

This will require the purchase and installation of mounting brackets to attach an existing frame. **There are no pre-drilled holes**, allowing you to use the hardware of your choice.

JMAP61 Optional Adapter Plate



UPHOLSTERED HEADBOARD — OPTION

By adding fabric or leather to select headboards, create a dramatic custom headboard.





CHARGING STATION – OPTION

This wireless age we live in often has more wires than we know what to do with. Our nightstand charging station offers a solution to un-complicate your life. Well, at least part of it. The charging station is an outlet extension installed into the back of one of the drawers in your nightstand, allowing for up to three separate device chargers to be plugged in at once... without all the mess.

MEOCS



CUSTOM HARDWARE – OPTION

Because everyone is different we understand that our selection may not be your first choice. Therefore, feel free to select a different hardware from our assortment starting on page 25.



INTERIOR SECRET DRAWER – OPTION

Our optional secret drawer with SmartTouch hardware turns any nightstand into the perfect hiding place.

MEOSD



NIGHTLIGHT – OPTION

Motion activated, and installed underneath the nightstand — our nightstand light is perfect for those times you need to get up without disturbing your partner.

The sensor is installed on the back corner and can be ordered to go either on the left or right side of the nightstand.

MEONL-L Left Facing Sensor

MEONL-R Right Facing Sensor



AROMATIC CEDAR DRAWER BOX – OPTION

For generations, cedar has been widely used in bedroom furniture with the purpose of discouraging insects and providing a pleasant aroma.

MEOCLDB



UP TO 6" SHORTER OR TALLER NIGHTSTAND – OPTION

We've added an option that allows you to increase or reduce the overall height of your nightstand up to 6" either way, in 1/2" increments.

ME06T



UP TO 6" WIDER OR NARROWER NIGHTSTAND – OPTION

We've added an option that allows you to increase or reduce the overall width of your nightstand up to 6" either way, in 1/2" increments.

ME06WNS With Drawers

ME06WNSDO With Doors or Opening



DINING ROOM FEATURES Crafted to perfection, just like your grandmother’s apple pie. There’s no other room that brings families together like the dining room. That’s why we build dining furniture to last, so that your family can continue to build memories for generations to come.

BALL-BEARING SLIDES – STANDARD

Standard on all tables, unless otherwise noted. Our sturdy built ball-bearing slides, custom made for us in Germany, provide years of smooth reliable operation. These top of the line slides come with our lifetime warranty, affording you, the original owner, protection against defects of materials or craftsmanship.

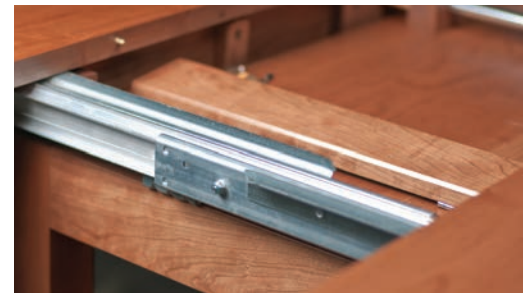

LEAF LOCKS – STANDARD

Now standard on most tables, all leaves are equipped with Leaf Locks. Exceptions will be noted in the catalog.



LEG LEVELERS – STANDARD

Because we know that there is nothing worse than a table that rocks back and forth, we put leg levelers on all wood bases/legs of our tables, including the center support leg.

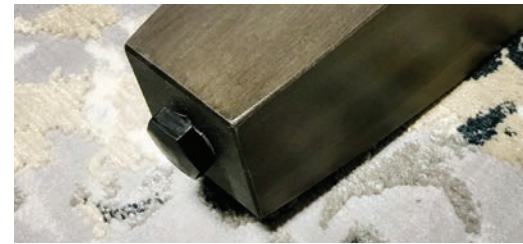

DINING ROOM OPTIONS

SILVERWARE DIVIDER – OPTION

Do you want your salad fork mingling with your soup spoon? Tired of getting poked by your corkscrew? Stop the insanity!

Our Silverware divider option even allows you to choose the drawer it goes into.

KCOSD





LEAVES Butterfly, drop leaf, in-table storage — you name it, and we offer it, giving you great options for expanding your table when you need extra room, and storing your leaves when you don't.

REGULAR LEAVES

Regular leaves are additional surface sections that require additional physical storage when they're not in use.

SELF-STORING LEAVES

Regular leaves stored inside the table. Some leaves may not have aprons, depending on your table configuration.

DROP LEAF

Drop leaves are simply hinged leaves that hang at the side when they're not in use. Available on studio tables.

BUTTERFLY LEAVES

Butterfly leaves are physically attached to the table and manually unfold from a central storage compartment. Available on leg, single pedestal and trestle tables. Standard on island tables.

STATIONARY BUTTERFLY LEAF

The stationary butterfly leaf will be found in trestle tables, leg tables, and island tables except where otherwise noted. Stationary butterfly leaves come in different sizes, with the trestle tables having the largest leaf coming in at a record setting 32" wide. The leg table comes in second with a 24" wide leaf. The Island Tables feature an 18" wide leaf.



Step 1 Open the table to expose the entire stored butterfly leaf. This may require you to release the table locks located on both sides of most of our tables.

Step 2 Firmly grasp both halves of the butterfly leaf on the opposite end of the hinges. Making sure your fingers are clear of the rest of the table, pull up on both halves at the same time, transferring the still folded leaf to the other side of the table.

Step 3 Release the aprons (some tables will not have aprons due to the design of the table or size restrictions). Don't forget to release both aprons before moving on to step 4.

Step 4 Firmly grasp the top half of the butterfly leaf, leaving the bottom half in place, pulling up and swinging the top half in place on the opposite side of the table.

Step 5 Gently push the table together, making sure the pins and holes are lined up properly before pushing it together tightly. Please note: if you feel something restricting you from closing the table easily, chances are you forgot to release one or both of the aprons properly as noted in step 3.

Storing your butterfly leaf Retrace your steps starting from the bottom and working your way back up to closing the table and locking it. Enjoy!

SLIDING BUTTERFLY LEAF

The sliding butterfly leaf was invented by us to allow for more tables to accommodate butterfly leaves without spoiling the beautiful design of the table. The sliding butterfly leaf will be found in Single Pedestal tables. Sliding butterfly leaves don't have aprons or leaf locks due to space restrictions in those tables using this leaf. The sliding butterfly leaves featured in our single pedestal tables are 18" wide.

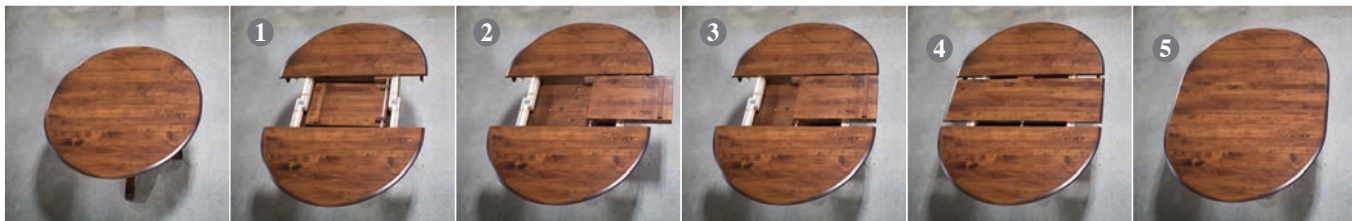

Step 1 Open the table to expose the entire stored butterfly leaf. This may require you to release the table locks located on both sides of most of our tables.

Step 2 Firmly grasp both halves of the butterfly leaf on the opposite end of the hinges. Making sure your fingers are clear of the rest of the table, pull up on both halves at the same time, transferring the still folded leaf to the other side of the table.

Step 3 Gently slide the leaf over until it lines up with the edge of the table.

Step 4 Firmly grasp the top half of the butterfly leaf, leaving the bottom half in place, pulling up and swinging the top half in place on the opposite side of the table.

Step 5 Gently push the table together, making sure the pins and holes are lined up properly before pushing it together tightly.

Storing your butterfly leaf Retrace your steps starting from the bottom and working your way back up to closing the table and locking it. Enjoy!

END OF TABLE BUTTERFLY LEAF

The newest member of our butterfly leaf family, this option is only available on a select few tables, mainly because it requires the end of the table to be mostly square so the leaf lines up without large gaps. The tables we offer this leaf on will also have limited edge profile options. The end of table butterfly leaf utilizes a new heavy duty table slide that transfers the stored leaf out from under the end of the table and then supports the weight of the extended leaf and your fabulous spread as well. The end of table butterfly leaves are 18" wide. Tables with this leaf will feature one on each end, adding 36" total to your dining surface.



Step 1 Reach under the end of the table and pull on the apron to completely expose the entire stored butterfly leaf.

Step 2 Firmly grasp both halves of the butterfly leaf on the opposite end of the hinges. Making sure your fingers are clear of the rest of the table, pull up on both halves at the same time, transferring the still folded leaf to the other side of the table.

Step 3 Firmly grasp the top half of the butterfly leaf, leaving the bottom half in place, pulling up and swinging the top half in place on the opposite side of the table.

Step 4 Gently push the end apron and carriage in under the butterfly leaf.

Step 5 Lock the latch hook located near the center of the leaf to secure leaf to the table.

Storing your butterfly leaf Retrace your steps starting from the bottom and working your way back up to closing the table and locking it. Enjoy!



CHAIR FEATURES Shapely legs? Solid backs? Relax; we're talking about the sturdy construction of our chairs, built to withstand the rigors of everyday use. Choose from several styles. Soon, you'll be sitting pretty.



Every chair has all the joints reinforced with screws to ensure that the chair will last a lifetime.

CHAIR GLIDES – STANDARD

Each chair that is hand-crafted at Simply Amish comes standard with high quality glides to protect floors from scratching.

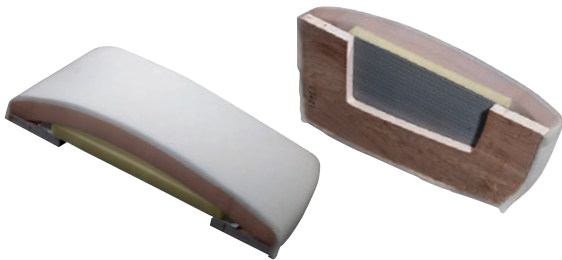

QUALITY SEAT CUSHIONS – STANDARD

Every seat cushion is constructed to optimize comfort for the life of the product. Each of our dining chair cushion seats are constructed the same way, so if you have tried one you have tried them all.



CASTERS – OPTION **C**

Many of our dining chairs come with the option of adding casters.

KACOC



CUSTOM FABRICS – OPTION

At Simply Amish we've built our business on creating products just the way you want them, and this applies to upholstery as well. Therefore, if you have a fabric in mind and we don't offer it — send us your fabric and we've got you covered.

For dining chairs with an upholstered seat we will require ½ yard per chair.

For dining chairs with an upholstered seat and back we will require 1½ yards per chair. Exceptions are noted on the product page. COM fabric will be priced as Grade 3.

If supplying your own fabric, excess fabric will NOT be returned.

If you want to supply your own leather, you will need to submit a quote request.

Note: Customer supplied (COM) fabric yardages are estimated on product pages. Since fabric repeats can vary, if there's a question, please call for specifics. Unused COM fabric will not be returned. Items purchased with COM fabric are priced as grade 3.

Find our current list of fabrics at www.SimplyAmish.com/choices/fabric/

ADVANTAGE FABRICS

These fabrics are available as part of a special arrangement with the fabric mill to purchase three of their most popular fabrics in higher quantities and to pass the savings on to the consumer. Available on dining seating.



Flint



Linen

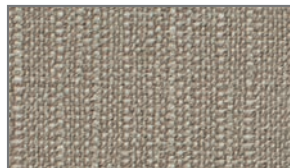

Pewter



NAILHEADS – OPTION

Looking to set your dining room apart? With our nailhead options it's simple to add a touch of class. See price list for availability.



Oxford Hammered
ECONH-OX



Z Finish
ECONH-ZF



Black
ECONH-BK



Pewter Nickel
ECONH-PN



Pewter Zinc
ECONH-PZ



Natural
ECONH-NT



French Natural
ECONH-FN

SAOVNAILS
SAOVNAILB

Nailhead Option for Chair Seat of Upholstered Chair.
Nailhead Option for Chair Back of Upholstered Chair.

BARSTOOL FEATURES

Our barstools are available in two basic types — stationary and swivel. On stationary stools, the legs are attached directly to the base, just like a typical chair, while swivel barstools feature hardware that allows the seat to rotate while the legs remain in place.

Stationary Barstools are available in your choice of two seat heights — 24" or 30".

Swivel Barstools are available in your choice of two seat heights — 24" or 30".

STANDARD SWIVELS – STANDARD

All swivel barstool selections feature this icon, indicating that your selection features a heavy-duty, ball-bearing swivel designed to pivot a full 360°. These high-quality swivels are made in America and backed by our lifetime guarantee.

MEMORY SWIVELS – OPTION

For a slight upcharge, you can upgrade any Standard Swivel to a Memory Swivel. These deluxe swivels — also backed by our lifetime guarantee — are designed to rotate 90° in either direction and return to the forward-facing position whenever the seat is unoccupied.

KAOFMS
KAOMS

Backless Memory Upgrade
Standard to Memory Upgrade

RUNG GUARDS – OPTION

Protect your investment with our optional Stainless Steel Rung Guards. Installed to protect the finish on the area of the barstool that takes the most abuse, the cross bar. Can be installed on any barstool that has a rectangular cross bar.

KAOBB
KAOBR

Bronze Finish
Brushed Stainless Finish



Stationary Barstool



Swivel Barstool



Bronze



Brushed Stainless



WORK FEATURES



FILE DRAWERS – FEATURE

File Drawers feature hanging file hardware.



GAS LIFTS – FEATURE

All of our desk chairs feature gas lifts. Add a touch of luxury to your office or home. The gas lift allows easy positioning of the swivel seat.



LED TOUCH LIGHTS – FEATURE



Forget about fumbling for a cord or hunting for a hidden light switch. Our convenient cabinet touch lights allow you to turn on, turn off, or dim your lights with a simple touch.

GLASS OPTIONS

Variety is the spice of life! With five different styles of glass to choose from, your selection can dramatically impact the look and feel of your furniture.



Plain



Beveled

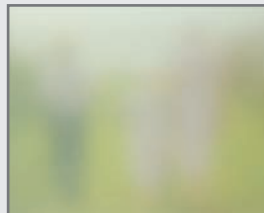

Frosted



Water



Antique

UPHOLSTERY FEATURES When it comes to seating, we focus heavily in a spot that most folks never see. It's called the deck, and at Simply Amish it's built strong and reinforced for comfort and years of reliable use, providing more upside for your backside. You'll find these features on all non-reclining and stationary seating selections.

- a Each deck surface features a strong denim central panel, surrounded by matching cushion fabric.
- b Underneath the deck, heavy gauge springs are fastened with clips front-to-back, providing comfort and durability.
- c A thick foam core above the springs offers luxurious comfort, while a black cambric bottom provides a barrier against dust.

Qualux Ultra. The Qualux® Ultra Cushion is considered the best seating foam available in the upholstery industry. Resilient when compressed, Qualux Ultra provides exceptional support and increased uniformity from cushion to cushion. And because of its superior quality, it's backed by a limited lifetime warranty. See page 2 for more details.

- d The cushion core's high support provides years of comfortable support.
- e Polyester fiber offers extra support, along with a luxurious crown.
- f Qualux super-soft polyurethane adds to your seating comfort.

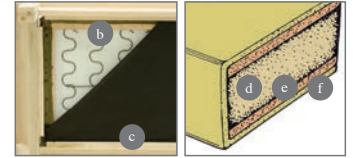

UPHOLSTERY OPTIONS

- a — 2-Cushion Back
- b — Bench Seat
- c — Boxed Cushions
- d — Contrasting welt



WALLHUGGER — FEATURE/OPTION

Our wallhugger feature comes standard on all loveseat and sofa recliners, allowing you to recline just 5" from the wall. This feature is available for recliners as well. Please see the price list for additional information.



Standard Recliner

POWER RECLINE — OPTION

Adding power to one of our comfortable recliners will allow you to stop at any position! Uses a wired control wand.

- LCMPO-01** Motorized Power Option, Single Recliner
- LCMPO-02** Motorized Power Option, Loveseat Recliner
- LCMPO-03** Motorized Power Option, Sofa Recliner



Wallhugger Recliner

BATTERY — OPTION ⚡

This option, added to the Power Recline option, will allow you to sit in your recliner in the middle of the room — No power cord. Battery is rechargeable. **LC-BATTERY**

For a complete list of our available fabrics and leather, go to SimplyAmish.com/choices/fabric.

FABRICS & LEATHER

Fabrics:

Fabrics are graded with grades 2 through 11. The higher the grade, the more expensive the fabric will be, though not necessarily the higher the quality of the fabric. Several factors go into the pricing of fabrics. Higher grade fabrics may require more material due to pattern matching or may involve a more expensive process to make that particular fabric. The first number in the fabric SKU is the grade.

Occasionally, we can combine grades into a single price point, while other times each grade needs to be priced individually. Fabric prices for each item can be found in the price list.

Many of our fabrics are Performance Fabrics, which are more resistant to stains and can be cleaned more easily.

You may supply your own fabric (COM — Customer's Own Material). Please, check the catalog for the quantity of fabric needed for each item. Excess fabric will not be returned. COM is charged at grade 3.

Leather:

We use top grain leather that will last a long time. Certain colors may cost more. Our leathers are graded C through F. COL (Customer's Own Leather) requires a custom quote.



OCCASIONAL TABLE OPTION

UP TO 6" SHORTER OR TALLER END TABLE, CHAIR SIDE, COFFEE, OR SOFA TABLE – OPTION

We've added an option that allows you to increase or reduce the overall height of your end, chair side, coffee, or sofa table up to 6" either way, in ½" increments. See a price list for more information.



CUSTOM QUOTES

Too big? Too small? Need a different drawer configuration?

Quotes are something we do every day! From making changes in current items to creating something truly unique—it's what we do. If you don't find what you need in the price list, just fill out and send in a custom quote request.

Be aware that CUSTOM is almost always going to cost more. Whenever we need to alter a piece, effort must go into re-engineering that piece to the custom specifications. We do not give quotes over the phone. Please, email or fax a completed Custom Quote Request and we will email or fax back the final quote so that we both have the information in writing before you place an order.

See the front of the price list for a copy of our Custom Quote Form.

A screenshot of the 'Request for Custom Quote' form from Simply Amish. The form includes fields for Name, Address, Phone, Email, and a section for 'Item Description (Include Modification)'. It also has a 'Request for Custom Quote' button and a footer with contact information.

QUICKSHIP/EXPRESS (BEGINNING ON PAGE 444)



Because idle hands are the devil's workshop, we build some of our most popular pieces in advance.

You can't rush perfection. But at Simply Amish, we've discovered that you *can* nudge it along. Providing the same exceptional quality that you'll find in our regular line—in a much shorter time. The custom look without the custom wait. We have two programs to help you get select pieces of furniture faster than a normal order.

With Express, the items will be in stock in our most popular wood and stain for that item. With QuickShip, we take it one step further - the product will be available in a specific wood, and you get to choose from a variety of finishes to ensure that what you get will best complement your style. That's the only difference. Every amazing piece is still cut from the same beautiful hardwoods, hand-crafted and signed by the skilled artist who built it, and backed by our lifetime guarantee. The only thing you're losing is the wait.

Express



The items in our Express program are available in the wood and finish specified within this section. All these pieces are in our warehouse and available for immediate delivery. Items in our Express program will ship the fastest.

QuickShip



For our QuickShip program, we keep much of our Express furniture on hand – unfinished. This allows you to select the finish you want without having to wait for your furniture to be built from scratch. Choose any finish specific to the wood species shown.



HARDWARE Drawer pulls and other elements provide the final touch to your Simply Amish selection. Most of our furniture is available in your choice of hardware options, although some may require a slight additional charge. If you would like to supply your own hardware, we would be happy to install it for you.

Simply Amish sources only from high end hardware suppliers to provide the highest quality hardware available. Particular hardware is assigned to each collection and can be found on the first page of each collection in this catalog.

Hardware varies in price. The price group that a piece of hardware belongs to is indicated by the letter in the middle of the hardware SKU—"A" being the least expensive. Because you're able to order any of our hardware, you aren't limited to the standard hardware assigned to any collection. Hardware of the same price level or lower can be substituted at no charge.

If you want to upgrade to a higher level hardware, the upgrade price can be found in the front of the price list and will be applied for each piece of hardware on the item. You may also supply your own hardware. There is no credit for existing hardware if you upgrade or supply your own. Extra hardware may be purchased separately.



Flat Black

Knob	WK-A-05, 1 1/8" w
Knob	WK-A-07, 1 1/4" w
Pull	68-D-08, 6 3/4" w, 5" c-c
Pull	68-E-10, 6" w, 5" c-c
Pull	68-C-11, 6 3/8" w, 5 1/16" c-c
Knob	68-B-12, 1 1/4" w
Pull	68-C-13, 5 3/4" w, 5 1/16" c-c
Pull	68-C-14, 6 1/4" w, 5 1/16" c-c
Pull	68-C-15, 6 3/4" w, 6 1/16" c-c
Pull	68-B-18, 7 1/8" w, 6 1/4" c-c

Hand Forged Black

Knob & Plate 66-H-01

Knob: 1¼" w

Plate: 2⅜" w

Pull 66-I-02, 6" w, 4½" c-c

01

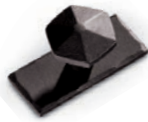

02



Black Mission

Door Pull 61-B-01, 4½" h, 3" c-c

Drawer Pull 61-B-02, 4½" w, 3" c-c

Drawer Pull 61-A-03, 3¾" w, 3" c-c

Door Pull 61-A-04, 3¾" h, 2¼" c-c

01



02



03



04



Nickel

Knob 70-B-01, 13/16" w

Knob 70-C-04, 1¼" w

Open Pull 70-E-10, 5½" w, 96mm c-c

Knob 70-E-11, 1⅝" w, 1" c-c

Open Pull 70-E-13, 6¼" w, 96mm c-c

Knob 70-E-14, 1⅝" l

Knob 70-B-20, 2½" w, 2" c-c

Pull 70-C-21, 4½" w, 3½" c-c

Pull 70-C-22, 4⅞" w, 96mm c-c

Knob 70-B-23, 1⅜" w

Pull 70-D-24, 6" w, 5⅜" c-c

Knob 70-B-25, 11/16" w

Pull 70-D-26, 4½" w, 3½" c-c

Pull 70-D-27, 4⅞" w, 3½" c-c

01



04



10



11



13



14



20



21



22



23

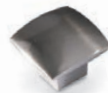

24



25



26



27





29



30



31



32



33



34



35



37



38



39



40



41



42



43



44



45



49

Nickel (continued)

- Knob 70-E-29, 1 1/8" w
- Pull 70-E-30, 5 1/2" w, 128mm c-c
- Pull 70-A-31, 6" w, 128mm c-c
- Pull 70-E-32, 6" w, 5" c-c
- Pull 70-C-33, 6 3/4" w, 6 1/8" c-c
- Pull 70-E-34, 9 1/4" w, 8 1/8" c-c
- Pull 70-C-35, 9 1/8" w, 6 5/8" c-c
- Knob 70-B-37, 1 1/4" w
- Pull 70-C-38, 5 5/8" w, 5 1/8" c-c
- Pull 70-C-39, 6 3/8" w, 5 1/8" c-c
- Pull 70-B-40, 5 1/2" w, 96mm c-c
- Knob 70-A-41, 1 1/8" w
- Pull 70-C-42, 6 3/4" w, 5" c-c
- Pull 70-B-43, 5 1/4" w, 3 3/4" c-c
- Knob 70-C-44, 1 3/8" w
- Knob 70-A-45, 1 1/8" w
- Pull 70-E-49, 8" w, 6 1/4" c-c



01



12



13

Weathered Nickel

- Knob 80-B-01, 1 3/8" w
- Pull 80-E-12, 5 1/2" w, 3 3/4" c-c
- Ring Pull 80-B-13, 1 1/2" w



01



01



02

Ash Gray

- Pull 83-E-01, 7" w, 6 1/4" c-c

Brushed Pewter

- Pull 82-B-01, 5 1/8" w, 3 3/4" c-c
- Pull 82-B-02, 7 1/8" w, 6 1/4" c-c

Brushed Antique Copper

- Knob 92-C-05, 1 $\frac{3}{8}$ "l
- Pull 92-D-06, 5 $\frac{1}{2}$ "w, 96mm c-c
- Knob 92-B-07, 1 $\frac{3}{8}$ "w
- Pull 92-F-11, 8 $\frac{5}{8}$ "w, 8" c-c
- Pull 92-C-12, 7" w, 6 $\frac{1}{16}$ " c-c
- Pull 92-E-13, 9 $\frac{3}{8}$ " w, 8 $\frac{9}{16}$ " c-c

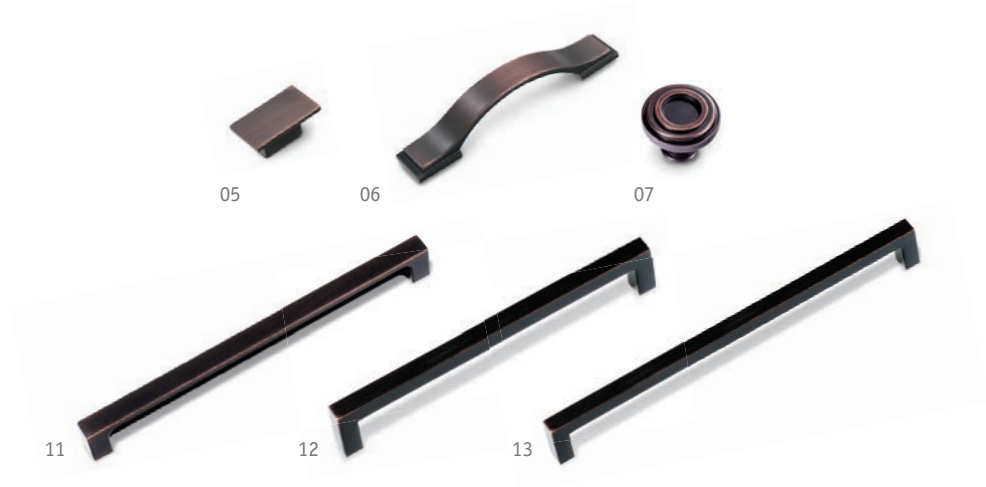

Weathered Copper

- Knob 90-B-04, 1 $\frac{1}{4}$ "w
- Pull 90-D-05, 4" w, 3" c-c



Wrought Iron

- Knob 62-A-01, 1 $\frac{1}{4}$ "w
- Pull 62-D-02, 4" w, 3" c-c

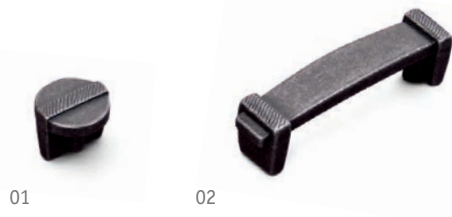

Oil Rubbed Bronze

- Knob 95-C-01, 1 $\frac{1}{4}$ "w
- Pull 95-D-02, 5 $\frac{3}{4}$ "w, 5 $\frac{1}{16}$ " c-c
- Pull 95-C-03, 4 $\frac{5}{8}$ "w, 3 $\frac{3}{4}$ " c-c
- Knob 95-B-04, 1 $\frac{1}{2}$ "l
- Pull 95-D-05, 6 $\frac{1}{8}$ "w, 5 $\frac{1}{16}$ " c-c
- Pull 95-C-06, 9 $\frac{1}{4}$ "w, 6 $\frac{1}{16}$ " c-c
- Knob 95-B-07, 1 $\frac{1}{16}$ "w
- Pull 95-B-08, 5 $\frac{1}{4}$ "w, 3 $\frac{3}{4}$ " c-c
- Knob 95-A-09, 1 $\frac{1}{8}$ "w



German Bronze

- Pull 94-D-01, 5" w, 3 $\frac{3}{4}$ " c-c





01



02



03

Honey Bronze

Pull 41-E-01, 8" w, 6¼" c-c

Knob 41-B-02, 1½" w

Pull 41-E-03, 7" w, 6¼" c-c



01

Dark Antique Brass

Knob & Plate 63-A-01, 1¼" w, 1¾" l



01



02



03

Black Hammered Brass

Knob 60-F-01

Knob: 1½" w

Plate: 1¼" w

Door Pull 60-G-02, 4" h

Drawer Pull 60-G-03, 3¾" w, 3" c-c



01



02

Darkened Hammered Brass

Door Pull 65-D-01, 4¾" h, 2½" c-c

Drawer Pull 65-D-02, 4¾" w, 2½" c-c



01



03

Antique English

Knob 20-A-01, 1½" w

Drawer Pull 20-A-03, 5" w, 3" c-c



01



04

Brushed Brass

Knob 40-B-01, 1¾" w

Drawer Pull 40-G-04, 4" w, 3" c-c



01



02



03



04



06

Wood Knobs

Knob WK-A-01, 1½" w

Knob WK-A-02, 1½" w

Knob (walnut) WK-A-03, 1¼" w

Knob WK-A-04, 1½" w

Knob WK-A-06, 1½" w

Select wood and stain for hardware.

ASPEN

SLEEP



E. Chupp

ASPEN BEDROOM – SHOWN IN CHERRY, MICHAEL'S



This style comes standard with Flat Black Knob (WK-A-05).



a Aspen Panel Bed with Inlay

Headboard: 50" h; Footboard: 31" h

CA King	78½" w x 93" d	SBASP-05B1
King	82½" w x 89" d	SBASP-05B2
Queen	66½" w x 89" d	SBASP-05B3
Full	60½" w x 85" d	SBASP-05B4
Twin	45½" w x 85" d	SBASP-05B5

b Aspen Panel Bed with Footboard Storage

Headboard: 50½" h; Footboard: 18½" h

CA King	78½" w x 89½" d	SBASP-05F1
King	82½" w x 85½" d	SBASP-05F2
Queen	66½" w x 85½" d	SBASP-05F3
Full	60½" w x 81½" d	SBASP-05F4
Twin	45½" w x 81½" d	SBASP-05F5

Twin bed comes with only one drawer.

Some manufacturers use paint to simulate the look of inlaid wood. At Simply Amish our durable inlays are cut from strips of quality wood. These pieces are then glued into place, sanded flush with the surface and stained with the rest of the piece.



a



b

NO FOOTBOARD REQUIRED?

A wood frame version is available on most bed versions. The headboard remains the same, but the footboard is replaced with a wood frame.



Solid Foundation

No box springs required — the mattress sits on a rigid plywood foundation.

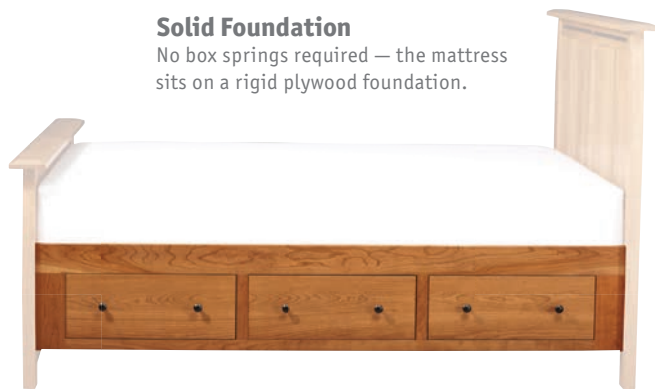

c

Does not include headboard or footboard.

a Aspen Slat Bed with Inlay

Headboard: 50" h; Footboard: 31" h

CA King	78½" w x 93" d	SBASP-10B1
King	82½" w x 89" d	SBASP-10B2
Queen	66½" w x 89" d	SBASP-10B3
Full	60½" w x 85" d	SBASP-10B4
Twin	45½" w x 85" d	SBASP-10B5

b Aspen Bookcase Bed with Inlay

Headboard: 54½" h; Footboard: 13¼" h

CA King	77½" w x 94¾" d	SBASP-01W1
King	81½" w x 90¾" d	SBASP-01W2
Queen	65½" w x 90¾" d	SBASP-01W3
Full	59½" w x 86¾" d	SBASP-01W4
Twin	44½" w x 86¾" d	SBASP-01W5

c Aspen Under-Bed Storage

Rail Top: 20"; Rail Bottom: 5½" from floor
Mattress Sits 2" Lower than Rail Top

CA King	SSASP-13A	👉
King/Queen	SSASP-13B	👉
Full	SSASP-13C	👉
Twin	SSASP-13D	👉

Sold separately from the bed.
Not available on Express Beds.

👉 Available with multiple drawer configurations.



EXPRESS



QUICKSHIP

simplyamish

FLIPPING SWEET.

Want to invert the beveled edge that crowns your Aspen furniture?

No problem. Just ask for the reverse bevel option. And get the Aspen look...Over easy.

(Items over 56" tall have bevel reversed on top surface as a standard feature)

Reverse Top on Aspen **ECAORT**

Reverse Top shown



a Aspen Short Chest with Inlay
40" w x 24" d x 33½" h ECA125SC

Aspen Dresser Mirror with Inlay
30" w x 4" d x 40" h ECAM100

Features a beveled edge mirror.

b Aspen Mule Chest with Inlay
54" w x 20¼" d x 44¾" h ECA314MC

Aspen Mule Chest Mirror with Inlay
45½" w x 3¾" d x 34" h ECAMCM

Features a beveled edge mirror.

c Aspen 6-Drawer Dresser with Inlay
60" w x 24" d x 33" h ECA1656D

70" w x 24" d x 33" h ECA21570-6

Aspen Tri-View Dresser Mirror with Inlay

51" w x 4" d x 40" h ECAM135
61" w x 4" d x 40" h ECAM140

Features a beveled edge mirror.

d Aspen 7-Drawer Dresser with Inlay
60" w x 24" d x 33" h ECA1607D

70" w x 24" d x 33" h ECA22070-7

Aspen Tri-View Dresser Mirror with Inlay

51" w x 4" d x 40" h ECAM135
61" w x 4" d x 40" h ECAM140

Features a beveled edge mirror.

e Aspen 12-Drawer Bureau with Inlay
↔ ↔

60" w x 24" d x 49" h ECA17012B

70" w x 24" d x 49" h ECA24512B

Aspen Bureau Mirror with Inlay
↔ ↔

55" w x 4" d x 30" h ECAM145
65" w x 4" d x 30" h ECAM150

Features a beveled edge mirror.



a



b



c



d



e



f



g

a Aspen 10-Drawer Bureau with Inlay

60" w x 24" d x 49" h ECA17010B

70" w x 24" d x 49" h ECA24510B

Same overall size as the 12-Drawer Bureau, but with deeper drawers

b Aspen Chest on Chest with Inlay

40" w x 25" d x 56½" h ECA225CC

c Aspen 9-Drawer Chest with Inlay

40" w x 24" d x 57" h ECA1759D

d Aspen Chifferobe with Inlay

49½" w x 25" d x 69¼" h ECA255C

Left Cabinet features two adjustable shelves and a removable clothes rod. Right Cabinet features an adjustable shelf.

e Aspen Chest Armoire with Inlay

40" w x 25" d x 71¼" h ECA130CA

Features an adjustable shelf.

f Aspen 3-Drawer Wardrobe with Inlay

40" w x 25" d x 72¼" h ECA1903DW

Features two adjustable shelves and a removable clothes rod.

g Aspen Tall Armoire on Chest with Inlay

40" w x 25" d x 78" h ECA205

Features three adjustable shelves and a clothes rod.



a



b

c



d



e

a Aspen Door Chest with Inlay

48" w x 25" d x 64" h ECA200DC

Features four adjustable shelves, two clothes rods and a mirror on the back of left side door.

b Aspen 5-Drawer Chest with Inlay

40" w x 24" d x 50" h ECA1005D

c Aspen 6-Drawer Chest with Inlay ⇌ ⇌

40" w x 24" d x 50" h ECA1806D

d Aspen Blanket Chest with False Fronts and Inlay

40" w x 19" d x 21" h ECA155BC-🍃

e Aspen Lingerie Chest with Inlay

27" w x 20" d x 49" h ECA105LC

🍃 Available with fabric cushion seat or leather cushion seat. If using your own fabric please supply 2 yards. COM=Grade 3.



a



b



c



d



e

a Aspen Nightstand with Drawers and Inlay 

26" w x 18" d x 31" h ECA120BC

Features a pullout surface under the top.

b Aspen Nightstand with Drawers and Inlay, Extra wide

32" w x 18" d x 32" h SNASP-02C4

Features a pullout surface under the top.

c Aspen Nightstand with Doors and Inlay

26" w x 18" d x 31" h ECA115NS

Features a pullout surface under the top and open space behind door.

d Aspen Nightstand with Opening and Inlay

26" w x 18" d x 31" h ECA110NS

e Aspen Nightstand Table with Drawer and Inlay

24" w x 18" d x 28" h ECA140BT

AUBURN BAY

SLEEP



AUBURN BAY BEDROOM – SHOWN IN SOFT MAPLE, RAWHIDE



This style comes standard with Brushed Satin Nickel Pull (70-C-35).



a Uses standard slats.



b Includes entire bed.

a Auburn Bay Planked Bed

Headboard: 56" h; Footboard: 18" h; Side rail: 10½" h

CA King	76½" w x 87½" d	SBABR-23B1
King	80½" w x 83½" d	SBABR-23B2
Queen	64½" w x 83½" d	SBABR-23B3
Full	58½" w x 79½" d	SBABR-23B4
Twin	43½" w x 79½" d	SBABR-23B5

b Auburn Bay Planked Bed with Footboard Storage

Headboard: 56" h; Footboard: 18" h

CA King	76½" w x 87½" d	SBABR-23F1
King	80½" w x 83½" d	SBABR-23F2
Queen	64½" w x 83½" d	SBABR-23F3
Full	58½" w x 79½" d	SBABR-23F4
Twin	43½" w x 79½" d	SBABR-23F5

Twin bed comes with only one drawer.



a



b

Includes entire bed.

Solid Foundation

No box springs required — the mattress sits on a rigid plywood foundation.



c

Does not include headboard or footboard.

a Auburn Bay Single Panel Bed

Headboard: 56" h; Footboard: 18" h

CA King	76½" w x 87½" d	SBABR-22B1
King	80½" w x 83½" d	SBABR-22B2
Queen	64½" w x 83½" d	SBABR-22B3
Full	58½" w x 79½" d	SBABR-22B4
Twin	43½" w x 79½" d	SBABR-22B5

b Auburn Bay Single Panel Bed with Footboard Storage

Headboard: 56" h; Footboard: 18" h

CA King	76½" w x 87½" d	SBABR-22F1
King	80½" w x 83½" d	SBABR-22F2
Queen	64½" w x 83½" d	SBABR-22F3
Full	58½" w x 79½" d	SBABR-22F4
Twin	43½" w x 79½" d	SBABR-22F5

Twin bed comes with only one drawer.

c Auburn Bay Under-Bed Storage

Rail Top: 20"; Rail Bottom: 5½" from floor
Mattress Sits 2" Lower than Rail Top

CA King	SSABR-18A4
King/Queen	SSABR-18B4
Full	SSABR-18C4
Twin	SSABR-18D4
Twin	SSABR-18D2

Sold separately from the bed.

Available with multiple drawer configurations.



a



b



c

a Auburn Bay 6-Drawer Dresser

65" w x 18 3/4" d x 36 1/2" h SSABR-08F2
 72" w x 18 3/4" d x 36 1/2" h SSABR-08F3

b Auburn Bay 5-Drawer Chest

34" w x 18 3/4" d x 55" h SSABR-04E0

c Auburn Bay 8-Drawer Dresser

65" w x 18 3/4" d x 45 3/4" h SSABR-08H2
 72" w x 18 3/4" d x 45 3/4" h SSABR-08H3



a



b



c

a Auburn Bay 2-Drawer Nightstand
22½" w x 18¾" d x 28" h SNABR-02A1

b Auburn Bay 2-Drawer Nightstand, Extra Wide
30" w x 18¾" d x 28" h SNABR-02B4

c Auburn Bay Nightstand with Opening
22½" w x 18¾" d x 28" h SNABR-09A1

B&O RAILROAD®

SLEEP



SHOWN IN CHARACTER CHERRY, BOURBON



This style comes standard with Flat Black Pull (66-I-02).



a



b

Includes entire bed.

a B&O Railroad® Trestle Bridge Panel Bed

Headboard: 53" h; Footboard: 30" h

CA King	84" w x 91" d	SBTRB-05B1
King	88" w x 87" d	SBTRB-05B2
Queen	72" w x 87" d	SBTRB-05B3
Full	66" w x 83" d	SBTRB-05B4
Twin	51" w x 83" d	SBTRB-05B5

b B&O Railroad® Trestle Bridge Panel Bed with Footboard Storage

Headboard: 53" h; Footboard: 18½" h

CA King	84" w x 91" d	SBTRB-05F1
King	88" w x 87" d	SBTRB-05F2
Queen	72" w x 87" d	SBTRB-05F3
Full	66" w x 83" d	SBTRB-05F4
Twin	51" w x 83" d	SBTRB-05F5

Twin bed comes with only one drawer.

NO FOOTBOARD REQUIRED?

A wood frame version is available on most bed versions. The headboard remains the same, but the footboard is replaced with a wood frame.



Solid Foundation

No box springs required — the mattress sits on a rigid plywood foundation.



a Does not include headboard or footboard.



b



c

a B&O Railroad® Trestle Bridge Under-Bed Storage

Rail Top: 20"; Rail Bottom: 5½" from floor

Mattress Sits 2" Lower than Rail Top

CA King	SSTRB-13A
King/Queen	SSTRB-13B
Full	SSTRB-13C
Twin	SSTRB-13D

Sold separately from the bed.

b B&O Railroad® Trestle Bridge 9-Drawer Bureau

62" w x 22" d x 48¼" h SSTRB-03J2

72" w x 22" d x 48¼" h SSTRB-03J3

B&O Railroad® Trestle Bridge Bureau Mirror

57" w x 28¾" h SMTRB-01A2

67" w x 28¾" h SMTRB-01A3

Features a beveled edge mirror.

c B&O Railroad® Trestle Bridge 7-Drawer Dresser

62" w x 22" d x 35¼" h SSTRB-08G2

72" w x 22" d x 35¼" h SSTRB-08G3

B&O Railroad® Trestle Bridge Dresser Mirror

43½" w x 38¾" h SMTRB-06A2

53½" w x 38¾" h SMTRB-06A3

Features a beveled edge mirror.

Available with multiple drawer configurations.



a



b



c



d

Plank Tops and Ends — Standard on B&O Case Goods.

a B&O Railroad® Trestle Bridge Mule Chest

54" w x 19" d x 44" h SSTRB-11J0

B&O Railroad® Trestle Bridge Mule Chest Mirror

47½" w x 28¼" h SMTRB-08A0

Features a beveled edge mirror.

b B&O Railroad® Trestle Bridge 6-Drawer Chest

44" w x 22" d x 52" h SSTRB-04F0

c B&O Railroad® Trestle Bridge Lingerie Chest

28" w x 19" d x 53" h SSTRB-15E0

d B&O Railroad® Trestle Bridge Blanket Chest

41" w x 19" d x 22½" h SSTRB-02B0

Features false fronts.



Plank Tops and Ends – Standard on B&O Case Goods.

a B&O Railroad® Trestle Bridge Nightstand with Drawers
32" w x 20" d x 31½" h SNTRB-02C1

b B&O Railroad® Trestle Bridge Nightstand Table
26" w x 22" d x 31½" h SNTRB-01E1

c B&O Railroad® Trestle Bridge Nightstand with Opening
32" w x 20" d x 31½" h SNTRB-04A1

BEAUMONT

SLEEP



S. Kauffman

SHOWN IN SOFT MAPLE, MOCHA NUT



This style comes standard with Nickel Pulls (70-E-30).



a

Wood frame version available.

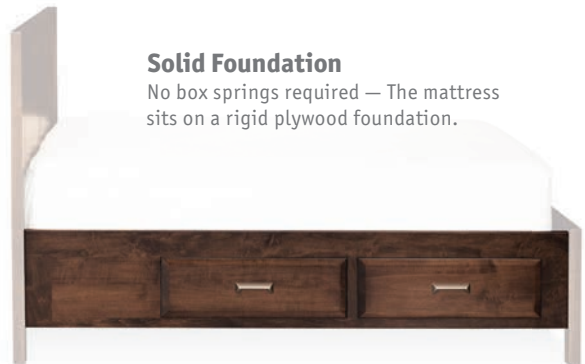

b

Solid Foundation

No box springs required — The mattress sits on a rigid plywood foundation.

Does not include headboard or footboard.
Shown with two drawers each side configuration.

a Beaumont Panel Bed

Headboard: 49" h; Footboard: 20" h

CA King	76½" w x 87½" d	SBBEU-05B1
King	80½" w x 83½" d	SBBEU-05B2
Queen	64½" w x 83½" d	SBBEU-05B3
Full	58½" w x 79½" d	SBBEU-05B4
Twin	43½" w x 79½" d	SBBEU-05B5

b Beaumont Under-Bed Storage

Rail Top: 20"; Rail Bottom: 5½" from floor

Mattress Sits 2" Lower than Rail Top

CA King	SSBEU-13A
King/Queen	SSBEU-13B
Full	SSBEU-13C
Twin	SSBEU-13D

Sold separately from the bed.

Available with multiple drawer configurations



a



b



c



d



e

- a Beaumont 12-Drawer Bureau**
 60 $\frac{1}{4}$ "w x 18"d x 48"h SSBEU-03M2
 70 $\frac{1}{4}$ "w x 18"d x 48"h SSBEU-03M3
Beaumont Bureau Mirror
 48 $\frac{3}{4}$ "w x 26"h SMBEU-01A2
 58 $\frac{3}{4}$ "w x 26"h SMBEU-01A3
 Features a beveled edge mirror.

- b Beaumont 7-Drawer Dresser**
 60 $\frac{1}{4}$ "w x 18"d x 33 $\frac{1}{2}$ "h SSBEU-08G2
 70 $\frac{1}{4}$ "w x 18"d x 33 $\frac{1}{2}$ "h SSBEU-08G3
Beaumont Dresser Mirror
 35 $\frac{1}{4}$ "w x 36"h SMBEU-06A2
 45 $\frac{1}{4}$ "w x 36"h SMBEU-06A3
 Features a beveled edge mirror.

- c Beaumont Mule Chest**
 58"w x 18"d x 44"h SSBEU-11J0
Beaumont Mule Chest Mirror
 39 $\frac{1}{4}$ "w x 29"h SMBEU-08A0
 Features a beveled edge mirror.
d Beaumont 6-Drawer Chest
 40"w x 18"d x 50"h SSBEU-04F0
e Beaumont Nightstand with Drawers
 23"w x 18"d x 26 $\frac{3}{4}$ "h SNBEU-02B1

BELVEDERE

SLEEP



SHOWN IN CHERRY, BOURBON



This style comes standard with Nickel Pulls (70-C-22) and Knobs (70-C-44).



a Wood frame version available.

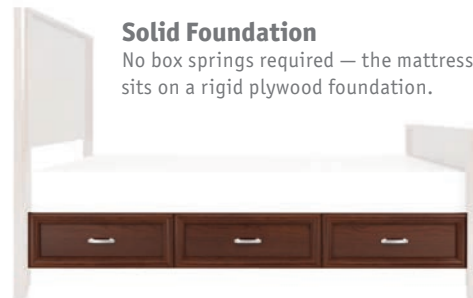

Solid Foundation

No box springs required — the mattress sits on a rigid plywood foundation.

b Does not include headboard or footboard.

a Belvedere Panel Bed

Headboard: 53" h; Footboard: 24½" h

CA King	80½" w x 92½" d	SBBEV-05B1
King	84½" w x 88½" d	SBBEV-05B2
Queen	68½" w x 88½" d	SBBEV-05B3
Full	62½" w x 84½" d	SBBEV-05B4
Twin	48½" w x 84½" d	SBBEV-05B5

b Belvedere Under-Bed Storage

Rail Top: 20"; Rail Bottom: 5½" from floor

Mattress Sits 2" Lower than Rail Top

CA King	SSBEV-13A	👉
King/Queen	SSBEV-13B	👉
Full	SSBEV-13C	👉
Twin	SSBEV-13D	👉

Sold separately from the bed.

👉 Available with multiple drawer configurations.



a



b



c



d



e



f

a Belvedere 6-Drawer Chest
43" w x 22½" d x 50¼" h SSBEV-04F1

b Belvedere 7-Drawer Dresser
60¾" w x 22¼" d x 35" h SSBEV-08G2
70¾" w x 22¼" d x 35" h SSBEV-08G3

Belvedere Dresser Mirror
39¼" w x 39" h SMBEV-06A0
49¼" w x 39" h SMBEV-06A1

c Belvedere Mule Chest
54¾" w x 19¾" d x 44" h SSBEV-11J0

Belvedere Mule Chest Mirror
43¼" w x 32" h SMBEV-08A0

d Belvedere 9-Drawer Bureau
60¾" w x 22¼" d x 47" h SSBEV-03J2
72" w x 22¼" d x 47" h SSBEV-03J3

Belvedere Bureau Mirror
52½" w x 27¾" h SMBEV-01A0
62½" w x 27¾" h SMBEV-01A1

e Belvedere 3-Drawer Nightstand
23¾" w x 20" d x 26¾" h SNBEV-02C1

f Belvedere Deluxe Nightstand with Drawers
31¾" w x 20" d x 32" h SNBEV-02C2

BRADEN

SLEEP



SHOWN IN SOFT MAPLE, AVALON



This style comes standard with Nickel Pulls (70-C-21).

S. Kaufman



a

Available with upholstered headboard option.
Wood frame version available.

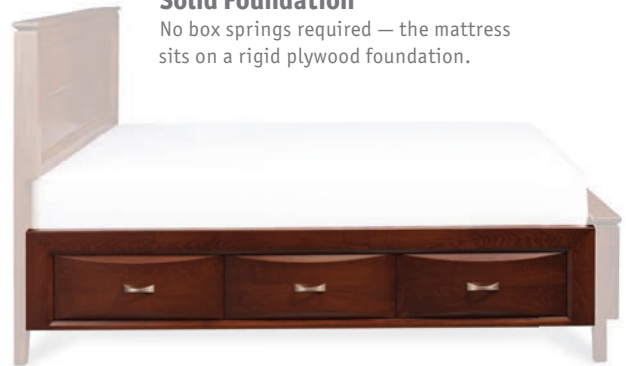

b

Solid Foundation

No box springs required — the mattress sits on a rigid plywood foundation.

Does not include headboard or footboard.

a Braden Panel Bed

Headboard: 49" h; Footboard: 21" h

CA King	77" w x 92" d	SBBRD-05B1
King	81" w x 88" d	SBBRD-05B2
Queen	65" w x 88" d	SBBRD-05B3
Full	59" w x 84" d	SBBRD-05B4
Twin	45" w x 84" d	SBBRD-05B5

b Braden Under-Bed Storage

Rail Top: 20"; Rail Bottom: 5½" from floor

Mattress Sits 2" Lower than Rail Top

CA King	SSBRA-13A	🍀
King/Queen	SSBRA-13B	🍀
Full	SSBRA-13C	🍀
Twin	SSBRA-13D	🍀

Sold separately from the bed.



a



b



c



d



e

a Braden 6-Drawer Dresser

60 $\frac{1}{4}$ "w x 21 $\frac{3}{4}$ "d x 35"h MEBR16D-60
70 $\frac{1}{4}$ "w x 21 $\frac{3}{4}$ "d x 35"h MEBR16D-70

Braden Dresser Mirror

39 $\frac{1}{4}$ "w x 39"h MEBR30-M
49 $\frac{1}{4}$ "w x 39"h MEBR30-L

Features a beveled edge mirror.

b Braden 12-Drawer Bureau

60 $\frac{1}{4}$ "w x 21 $\frac{3}{4}$ "d x 48 $\frac{1}{2}$ "h MEBR43-60B
70 $\frac{1}{4}$ "w x 21 $\frac{3}{4}$ "d x 48 $\frac{1}{2}$ "h MEBR43-70B

Braden Bureau Mirror

52 $\frac{3}{4}$ "w x 29"h MEBRSBM
62 $\frac{3}{4}$ "w x 29"h MEBRLBM

Features a beveled edge mirror.

c Braden 6-Drawer Chest

40 $\frac{1}{4}$ "w x 21 $\frac{3}{4}$ "d x 51"h MEBR15CD

d Braden Nightstand with Drawers

22 $\frac{1}{4}$ "w x 15 $\frac{3}{4}$ "d x 26"h MEBR19BC

e Braden Nightstand with Drawers, Extra Wide

32"w x 18"d x 32"h SNBRD-02C4

CLASSIC

SLEEP



This style comes standard with
Antique English Knobs (20-A-01)
and Pulls (20-A-03)

SHOWN IN CHERRY, BOURBON; SHOWN WITH OPTIONAL HARDWARE 40-G-04



a



b

Wood frame version available.

Shown with optional
Under-Bed Storage.

a Imperial Sleigh Bed

Headboard: 55" h; Footboard: 27" h

CA King	76" w x 97" d	SBIMP-09B1
King	80" w x 93" d	SBIMP-09B2
Queen	64" w x 93" d	SBIMP-09B3
Full	58" w x 89" d	SBIMP-09B4
Twin	43" w x 89" d	SBIMP-09B5

Not available with Under-Bed Storage

b Raised-Panel Bed

Headboard: 50" h; Footboard: 33" h

CA King	78½" w x 92" d	SBRPB-05B1
King	82½" w x 88" d	SBRPB-05B2
Queen	66½" w x 88" d	SBRPB-05B3
Full	60½" w x 84" d	SBRPB-05B4
Twin	45½" w x 84" d	SBRPB-05B5



Solid Foundation

No box springs required — the mattress sits on a rigid plywood foundation.

Does not include headboard or footboard.

a



b

c

d

a Classic Under-Bed Storage

Rail Top: 20"; Rail Bottom: 5½" from floor
 Mattress Sits 2" Lower than Rail Top

- CA King SSRPB-13A
- King/Queen SSRPB-13B
- Full SSRPB-13C
- Twin SSRPB-13D

Sold separately from the bed.

b Classic 7-Drawer Dresser

60" w x 21½" d x 34" h ME3316D
 70" w x 21½" d x 34" h ME3316-70D

Crown Tri-View Dresser Mirror

50¾" w x 40¾" h ME317TV
 63¾" w x 40¾" h ME3130TV

Features a beveled edge mirror.

Arch Top Tri-View Mirror (Inset)

50¾" w x 45¼" h ME317TVAT
 63¾" w x 45¼" h ME3130TVA

Features a beveled edge mirror.

c Classic Mule Chest

54" w x 18½" d x 44½" h ME314MC

Classic Mule Chest Mirror

44½" w x 2½" d x 32" h MEMCM-CR

Features a beveled edge mirror.

d Classic Short Chest

40½" w x 21½" d x 34½" h ME3120SC

Crown Top Center Mirror

29½" w x 40¾" h ME317CC

Features a beveled edge mirror.



a

SHOWN WITH OPTIONAL HARDWARE 40-G-04



b

Shown with optional
Arch Top – MEOAT



c



d



e

a Classic 12-Drawer Bureau

60" w x 21½" d x 47" h ME343-60B
70" w x 21½" d x 47" h ME343-70B

Crown Bureau Mirror

54" w x 29" h MESBMC
64" w x 29" h MELBMC

Features a beveled edge mirror.

Arch Top Bureau Mirror (Not Shown)

52" w x 35¼" h MESBMAT
62" w x 35¼" h MELBMAT

Features a beveled edge mirror.

b Classic Wardrobe

43" w x 22¼" d x 72½" h ME332WR

Features four adjustable shelves
and three clothes rods.

c Classic Tall Armoire on Chest

(Shown with optional Arch Top)
42" w x 22¼" d x 81½" h ME3322AC-1

Features three adjustable shelves and a clothes rod.

d Classic 6-Drawer Chest

40" w x 21½" d x 50½" h ME315CD

e Classic Lingerie Chest

23" w x 18½" d x 50½" h ME329LC



a



b



c



d



e



f

a Classic Blanket Chest with False Fronts
40" w x 20" d x 20½" h ME337BC-☞

b Classic Nightstand with Drawers
23" w x 15½" d x 27" h ME319BC

c Classic Deluxe Nightstand with Drawers
27" w x 18½" d x 32½" h ME3319SBC
Features a pullout surface under the top.

d Classic Nightstand with Drawers, Extra Wide
32" w x 18" d x 32" h SNCLA-02C4

e Classic Nightstand with Opening
23" w x 15½" d x 27" h ME305NS

f Classic Nightstand with Doors
23" w x 15½" d x 27" h ME318NS

Classic Deluxe Nightstand with Doors (Not Shown)
27" w x 18½" d x 32½" h ME3318SNS
Features a pullout surface under the top and one adjustable shelf behind the doors.

☞ Available with fabric cushion seat or leather cushion seat. If using your own fabric please supply 2 yards. COM = Grade 3.

COLBURN

SLEEP



SHOWN IN SOFT MAPLE, BOURBON



This style comes standard with Square Brushed Satin Nickel knob (70-B-23)



a

Wood frame version available.
Available with upholstered headboard option.

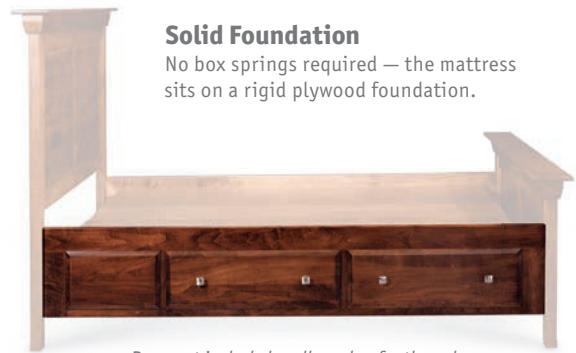

b

Solid Foundation

No box springs required — the mattress sits on a rigid plywood foundation.

Does not include headboard or footboard.

a Colburn Panel Bed

Headboard: 54 $\frac{3}{4}$ " ; Footboard: 28"

CA King	80 $\frac{1}{2}$ "w x 93 $\frac{1}{2}$ "d	SBCBN-05B1
King	84 $\frac{1}{2}$ "w x 89 $\frac{1}{2}$ "d	SBCBN-05B2
Queen	68 $\frac{1}{2}$ "w x 89 $\frac{1}{2}$ "d	SBCBN-05B3
Full	62 $\frac{1}{2}$ "w x 85 $\frac{1}{2}$ "d	SBCBN-05B4
Twin	47 $\frac{1}{2}$ "w x 85 $\frac{1}{2}$ "d	SBCBN-05B5

Twin size design features a single panel.

b Colburn Under-Bed Storage

Rail Top: 20"; Rail Bottom: 5 $\frac{1}{2}$ " from floor

Mattress Sits 2" Lower than Rail Top

CA King	SSCBN-13A	🍃
King/Queen	SSCBN-13B	🍃
Full	SSCBN-13C	🍃
Twin	SSCBN-13D	🍃

Sold separately from the bed.

🍃 Available with multiple drawer configurations.



a



b



c



d



e



f



g



h

a Colburn 12-Drawer Bureau
 58" w x 21½" d x 48½" h SSCBN-03M2
 68" w x 21½" d x 48½" h SSCBN-03M3
Colburn Bureau Mirror
 54½" w x 30½" h SMCBN-02A2
 64½" w x 30½" h SMCBN-02A3
 Features a beveled edge mirror.

b Colburn Mule Chest
 54" w x 18½" d x 45¾" h SSCBN-11J0
Colburn Mule Chest Mirror
 45" w x 33¾" h SMCBN-08A0
 Features a beveled edge mirror.

c Colburn 7-Drawer Dresser
 58" w x 21½" d x 34" h SSCBN-08G2
 68" w x 21½" d x 34" h SSCBN-08G3
Colburn Dresser Mirror
 41" w x 40½" h SMCBN-06A2
 51" w x 40½" h SMCBN-06A3
 Features a beveled edge mirror.

d Colburn 9-Drawer Chest
 39" w x 21½" d x 55¾" h SSCBN-04J0
e Colburn 6-Drawer Chest
 39" w x 21½" d x 49¾" h SSCBN-04F0
f Colburn Nightstand with Drawers
 22½" w x 15½" d x 26½" h SNCBN-02C1

g Colburn Nightstand with Opening
 22½" w x 15½" d x 26½" h SNCBN-04A1

h Colburn Nightstand with Drawers, Extra Wide
 32" w x 18" d x 32" h SNCBN-02C4

CRAWFORD

SLEEP



J. Kraft

SHOWN IN CHERRY, HAZELNUT



This style comes standard with Nickel Pull (70-E-10).



a



b

Includes entire bed.

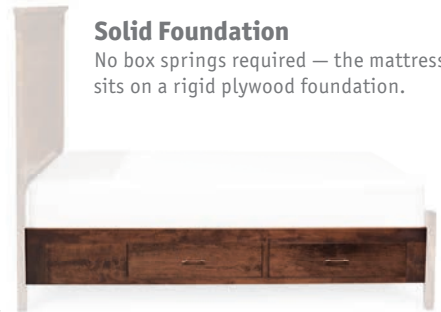

c

Does not include headboard or footboard.

Solid Foundation

No box springs required — the mattress sits on a rigid plywood foundation.

a Crawford Single Panel Bed

Headboard: 60" h; Footboard: 18" h

CA King	79¼" w x 87¼" d	SBCRA-05B1
King	83¼" w x 83¼" d	SBCRA-05B2
Queen	67¼" w x 83¼" d	SBCRA-05B3
Full	61¼" w x 79¼" d	SBCRA-05B4
Twin	46¼" w x 79¼" d	SBCRA-05B5

b Crawford Single Panel Bed with Footboard Storage

Headboard: 60" h; Footboard: 18" h

CA King	79¼" w x 87¼" d	SBCRA-05F1
King	83¼" w x 83¼" d	SBCRA-05F2
Queen	67¼" w x 83¼" d	SBCRA-05F3
Full	61¼" w x 79¼" d	SBCRA-05F4
Twin	46¼" w x 79¼" d	SBCRA-05F5

Twin bed comes with only one drawer.

c Crawford Under-Bed Storage

Rail Top: 20"; Rail Bottom: 5½" from floor
Mattress Sits 2" Lower than Rail Top

CA King	SSCRA-18A4	👉
King/Queen	SSCRA-18B4	👉
Full	SSCRA-18C4	👉
Twin	SSCRA-18D4	👉
Twin	SSCRA-18D2	👉

Sold separately from the bed.



a



b



c



d



e



f



g



h



i

- a Crawford 5-Drawer Chest**
46" w x 18" d x 47" h SSCRA-04E2
- b Crawford 6-Drawer Chest**
34" w x 18" d x 53½" h SSCRA-04F1
- c Crawford 7-Drawer Dresser**
60" w x 18" d x 36" h SSCRA-08G2
72" w x 18" d x 36" h SSCRA-08G3

- d Crawford 9-Drawer Dresser**
60" w x 18" d x 43" h SSCRA-08J2
72" w x 18" d x 43" h SSCRA-08J3
- e Crawford 8-Drawer Dresser**
60" w x 18" d x 36" h SSCRA-08H2
72" w x 18" d x 36" h SSCRA-08H3

- f Crawford 3-Drawer Nightstand**
24" w x 18" d x 30¾" h SNCRA-02C1
- g Crawford 4-Drawer Nightstand, Extra Wide**
30" w x 18" d x 30¾" h SNCRA-02D2
- h Crawford Nightstand Table**
24" w x 18" d x 30¾" h SNCRA-01A1
- i Crawford Nightstand Table, Extra Wide**
30" w x 18" d x 30¾" h SNCRA-01B2

DOVETAIL

SLEEP

REDESIGNED



Stuzman

SHOWN IN SOFT MAPLE, HAZELNUT



This style comes standard with Square Brushed Satin Nickel pull (70-B-43)



Wood frame version available.

a

a Dovetail Bed

Headboard: 47" h; Footboard: 24" h

CA King	74½" w x 92" d	SBD0V-05B1
King	78½" w x 88" d	SBD0V-05B2
Queen	62½" w x 88" d	SBD0V-05B3
Full	56½" w x 84" d	SBD0V-05B4
Twin	41½" w x 84" d	SBD0V-05B5



Case pieces feature custom Dovetail-Shaped Drawers.



a Dovetail 10-Drawer Bureau

60" w x 18" d x 46 1/4" h SSDOV-03K2
 70" w x 18" d x 46 1/4" h SSDOV-03K3

Dovetail Bureau Mirror

48 3/4" w x 31 3/4" h SMDOV-01A2
 58 3/4" w x 31 3/4" h SMDOV-01A3

Features a beveled mirror.

b Dovetail 5-Drawer Chest

36" w x 18" d x 41 1/4" h SSDOV-04E

c Dovetail 8-Drawer Dresser

60" w x 18" d x 34 1/4" h SSDOV-08H2
 70" w x 18" d x 34 1/4" h SSDOV-08H3

Dovetail Dresser Mirror

35 1/4" w x 41 3/4" h SMDOV-06A2
 45 1/4" w x 41 3/4" h SMDOV-06A3

Features a beveled mirror.

d Dovetail 3-Drawer Nightstand

22" w x 18" d x 26 3/4" h SNDOV-02C1

e Dovetail 3-Drawer Nightstand, Extra Wide

30" w x 18" d x 26 3/4" h SNDOV-02C4

EAST VILLAGE

SLEEP



S Kaufman

SHOWN IN SOFT MAPLE, JAVA



This style comes standard with Nickel Pulls (70-E-13).



a



b

Solid Foundation

No box springs required — the mattress sits on a rigid plywood foundation.

Does not include headboard or footboard.

a East Village Bed

Headboard: 49" h; Footboard: 14" h

CA King	77" w x 90" d	SBESV-10B1
King	81" w x 86" d	SBESV-10B2
Queen	65" w x 86" d	SBESV-10B3
Full	59" w x 82" d	SBESV-10B4
Twin	44" w x 82" d	SBESV-10B5

b East Village Under-Bed Storage

Rail Top: 20"; Rail Bottom: 5½" from floor

Mattress Sits 2" Lower than Rail Top

CA King	SSESV-13A
King/Queen	SSESV-13B
Full	SSESV-13C
Twin	SSESV-13D

Sold separately from the bed.

Available with multiple drawer configurations.



East Village Bureau Mirror



a



East Village Mule Chest Mirror



b



c



d



e



f



g

- a East Village 12-Drawer Bureau**
 60" w x 22½" d x 48¾" h MEV43-60
 70" w x 22½" d x 48¾" h MEV43-70
East Village II Bureau Mirror (Shown)
 52½" w x 33½" h MEVII3BM
 62½" w x 33½" h MEVII3LM
 Features a beveled edge mirror.
East Village Bureau Mirror (Inset)
 52½" w x 28" h MEEV3BM
 62½" w x 28" h MEEV3LM
 Features a beveled edge mirror.
- b East Village Mule Chest**
 54" w x 19½" d x 44½" h MEM314MC
East Village II Mule Chest Mirror (Shown)
 43" w x 36½" h MEMCM-EVII
 Features a beveled edge mirror.
East Village Mule Chest Mirror (Inset)
 43" w x 31" h MEMCM-EV
 Features a beveled edge mirror.
- c East Village 6-Drawer Dresser**
 60" w x 22½" d x 33¾" h MEV16D
 70" w x 22½" d x 33¾" h MEV16-70D
East Village Dresser Mirror (Shown)
 39" w x 38" h MEV30-M
 49" w x 38" h MEV30-L
 Features a beveled edge mirror.
East Village II Dresser Mirror (Inset)
 39" w x 43½" h MEVII30-M
 49" w x 43½" h MEVII30-L
 Features a beveled edge mirror.
- d East Village 6-Drawer Chest**
 42½" w x 22½" d x 50¾" h MEV15C
- e East Village Nightstand with Opening**
 23½" w x 16½" d x 28" h MEV05NS
 Opening: 14" w x 13½" d x 11¼" h
- f East Village Nightstand with Drawers**
 23½" w x 16½" d x 28" h MEV19BC
- g East Village Nightstand with Drawers, Extra Wide**
 32" w x 18" d x 32" h SNESV-02C4

ELROY

SLEEP



S. Kauffman

This style comes standard with finger pull drawers.

SHOWN IN CHERRY, AUTUMN HAZE WITH WALNUT, BOURBON ACCENTS

Select any wood and stain as an accent color (triangle panels and legs) on any Elroy piece at no additional cost.



a

a Elroy Panel Bed

Headboard: 36" h

CA King	74½" w x 93" d	SBELR-05B1
King	78½" w x 89" d	SBELR-05B2
Queen	62½" w x 89" d	SBELR-05B3
Full	56½" w x 85" d	SBELR-05B4
Twin	41½" w x 85" d	SBELR-05B5

Rolled Slats and 2-Tone Standard.



a



b



c

a Elroy 5-Drawer Chest

36" w x 18" d x 46" h
2-Tone Standard.

SSELR-04E0

b Elroy 8-Drawer Dresser

60" w x 18" d x 38" h
72" w x 18" d x 38" h
2-Tone Standard.

SSELR-08H2

SSELR-08H3

c Elroy 3-Drawer Nightstand

22" w x 18" d x 24" h
2-Tone Standard

SNELR-02C1

EMPIRE

SLEEP



This style comes standard with Wood Knobs (WK-A-01).

M. Miller

SHOWN IN QUARTERSAWN WHITE OAK, MICHAEL'S



a

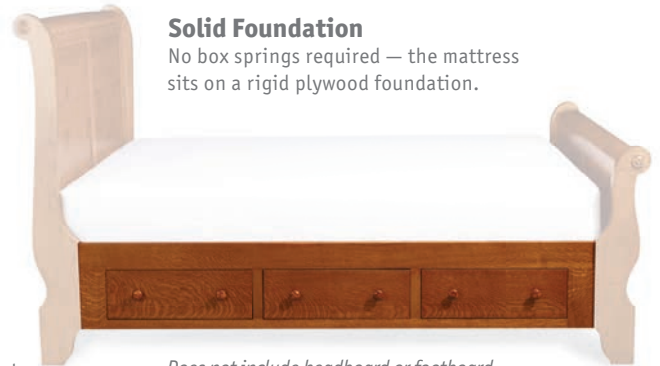

b

Solid Foundation

No box springs required — the mattress sits on a rigid plywood foundation.

Does not include headboard or footboard.

a Empire Sleigh Bed

Headboard: 52" h; Footboard: 32" h

CA King	75½" w x 96" d	SBEMP-09B1
King	79½" w x 92" d	SBEMP-09B2
Queen	63½" w x 92" d	SBEMP-09B3
Full	57½" w x 88" d	SBEMP-09B4
Twin	42½" w x 88" d	SBEMP-09B5

b Empire Under-Bed Storage

Rail Top: 18½"; Rail Bottom: 5½" from floor

Mattress Sits 2" Lower than Rail Top

CA King	SSEMP-17A
King/Queen	SSEMP-17B
Full	SSEMP-17C
Twin	SSEMP-17D

Sold separately from the bed.

Available with multiple drawer configurations.



a



b



c



d



e



f



g

a Empire 12-Drawer Bureau
 60" w x 22½" d x 48¾" h MEE43-60B
 70" w x 22½" d x 48¾" h MEE43-70B
Empire Bureau Mirror
 55½" w x 2½" d x 32¾" h MEESBM
 65½" w x 2½" d x 32¾" h MEELBM
 Features a beveled edge mirror.

b Empire 7-Drawer Dresser
 60" w x 22½" d x 34¾" h MEE167D
Empire Dresser Mirror
 40¾" w x 40" h MEEDMM
 Features a beveled edge mirror.

c Empire 6-Drawer Chest
 40" w x 22½" d x 50¾" h MEE15C

d Empire Lingerie Chest
 23" w x 19½" d x 50¾" h MEE29LC

e Empire Nightstand with Drawers
 23" w x 16½" d x 31¼" h MEE19BC

f Empire Nightstand with Drawers, Extra Wide
 32" w x 18" d x 32" h SNEMP-02C4

g Empire Nightstand With Doors
 23" w x 16½" d x 31¼" h MEE18NS
 Features open space behind doors.

FRISCO

SLEEP



SHOWN IN CHERRY, MOCHA NUT



This style comes standard with Nickel Pull (70-D-26).



Nightlight option available.

a



b

a Frisco Panel Bed with 26" Attached Nightstands

Headboard: 48 $\frac{3}{4}$ "h; Footboard: 15 $\frac{3}{4}$ "h;
Nightstands 24 $\frac{1}{4}$ "h

CA King	135 $\frac{1}{2}$ "w x 89 $\frac{1}{2}$ "d	BBFRI-14B1
King	139 $\frac{1}{2}$ "w x 85 $\frac{1}{2}$ "d	BBFRI-14B2
Queen	123 $\frac{1}{2}$ "w x 85 $\frac{1}{2}$ "d	BBFRI-14B3
Full	117 $\frac{1}{2}$ "w x 81 $\frac{1}{2}$ "d	BBFRI-14B4
Twin	98 $\frac{1}{2}$ "w x 81 $\frac{1}{2}$ "d	BBFRI-14B5

Features a centered grommet on nightstands.

Frisco Panel Bed with 18" Attached Nightstands

(Not Shown)

Headboard: 48 $\frac{3}{4}$ "h; Footboard: 15 $\frac{3}{4}$ "h;
Nightstands 24 $\frac{1}{4}$ "h

CA King	119 $\frac{1}{2}$ "w x 89 $\frac{1}{2}$ "d	BBFRI-28B1
King	123 $\frac{1}{2}$ "w x 85 $\frac{1}{2}$ "d	BBFRI-28B2
Queen	107 $\frac{1}{2}$ "w x 85 $\frac{1}{2}$ "d	BBFRI-28B3
Full	101 $\frac{1}{2}$ "w x 81 $\frac{1}{2}$ "d	BBFRI-28B4
Twin	82 $\frac{1}{2}$ "w x 81 $\frac{1}{2}$ "d	BBFRI-28B5

Features a centered grommet on nightstands.

b Frisco Panel Bed with 18" Attached Nightstands with No Upper Panel

Headboard: 48 $\frac{3}{4}$ "h; Nightstands 24 $\frac{1}{4}$ "h

CA King	119 $\frac{1}{2}$ "w x 89 $\frac{1}{2}$ "d	BBFRI-37B1
King	101 $\frac{1}{2}$ "w x 81 $\frac{1}{2}$ "d	BBFRI-37B2
Queen	123 $\frac{1}{2}$ "w x 85 $\frac{1}{2}$ "d	BBFRI-37B3
Full	107 $\frac{1}{2}$ "w x 85 $\frac{1}{2}$ "d	BBFRI-37B4
Twin	82 $\frac{1}{2}$ "w x 81 $\frac{1}{2}$ "d	BBFRI-37B5



a

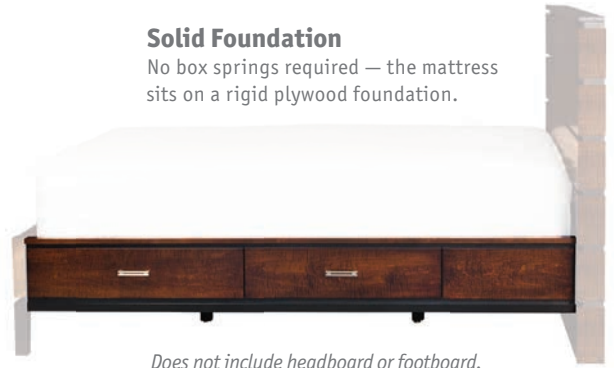

Solid Foundation

No box springs required — the mattress sits on a rigid plywood foundation.

Does not include headboard or footboard. Shown with two drawers each side configuration.

b



c



d



e



f

a Frisco Panel Bed

Headboard: 48¾" h; Footboard: 15¾" h
 CA King 83½" w x 89½" d BBFRI-05B1
 King 87½" w x 85½" d BBFRI-05B2
 Queen 71½" w x 85½" d BBFRI-05B3
 Full 65½" w x 81½" d BBFRI-05B4
 Twin 44½" w x 81½" d BBFRI-05B5

b Frisco Under-Bed Storage

Rail Top: 17½" ; Rail Bottom: 6¾" from floor. Mattress Sits 2" Lower than Rail Top
 CA King BSFRI-19A
 King/Queen BSFRI-19B
 Full BSFRI-19C
 Twin BSFRI-19D

Sold separately from the bed.

c Frisco Mule Chest

54" w x 19" d x 43½" h BSFRI-11J0

Frisco Mule Chest Mirror

45" w x 33" h BMFRI-08A0

d Frisco 7-Drawer Dresser

60" w x 22" d x 33" h BSFRI-08G2

70" w x 22" d x 33" h BSFRI-08G3

Frisco Dresser Mirror

41" w x 40" h BMFRI-06A2

51" w x 40" h BMFRI-06A3

e Frisco 5-Drawer Chest

40" w x 21½" d x 48" h BSFRI-04E0

f Frisco Nightstand with Drawers

25½" w x 16" d x 27" h BNFRI-02C1

Available with multiple drawer configurations

GARRETT

SLEEP



SHOWN IN CHERRY, MOCHA NUT



This style comes standard with Nickel Pulls (70-A-31).



a



b

Includes entire bed.

a Garrett Headboard with Wood Frame

Headboard: 48" h; Footboard: 13½" h

CA King	79½" w x 87¾" d	SBGAR-05W1
King	83½" w x 83¾" d	SBGAR-05W2
Queen	67½" w x 83¾" d	SBGAR-05W3
Full	61½" w x 79¾" d	SBGAR-05W4
Twin	46½" w x 79¾" d	SBGAR-05W5

b Garrett Panel Bed with Footboard Storage

Headboard: 49" h; Footboard: 18½" h

CA King	79½" w x 87¾" d	SBGAR-05F1
King	83½" w x 83¾" d	SBGAR-05F2
Queen	67½" w x 83¾" d	SBGAR-05F3
Full	61½" w x 79¾" d	SBGAR-05F4
Twin	46½" w x 79¾" d	SBGAR-05F5

Twin bed comes with only one drawer.

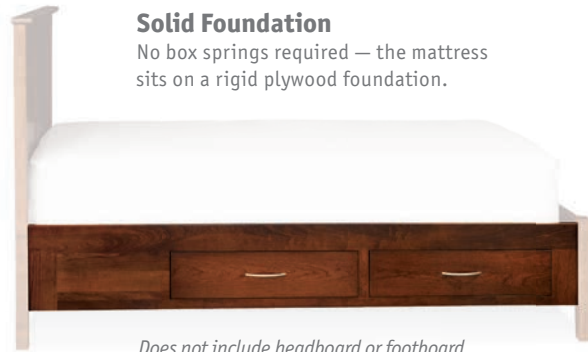

Solid Foundation

No box springs required — the mattress sits on a rigid plywood foundation.

a

Does not include headboard or footboard.

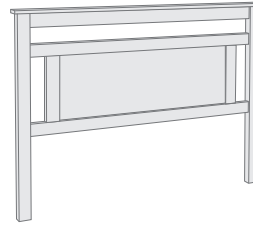

Horizon Open-Panel Headboard Option

SAOBED-OPEN

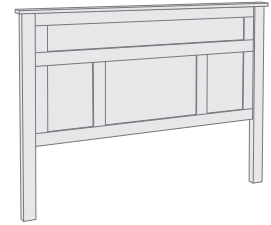

Horizon 4-Panel Headboard Option

SAOBED-4PANEL



b



c



d



e



f

a Garrett Under-Bed Storage

Rail Top: 17 $\frac{3}{4}$ " ; Rail Bottom: 5 $\frac{1}{4}$ " from floor
Mattress Sits 2 $\frac{1}{2}$ " Lower than Rail Top

- CA King SSGAR-18A
- King/Queen SSGAR-18B
- Full SSGAR-18C
- Twin SSGAR-18D

Sold separately from the bed.

b Garrett 7-Drawer Dresser

58" w x 18 $\frac{1}{2}$ " d x 36" h SSGAR-08G2

Garrett Dresser Mirror

40 $\frac{1}{2}$ " w x 37 $\frac{1}{4}$ " h SMGAR-06A2

Features beveled edge mirror.

c Garrett Mule Chest

54" w x 18 $\frac{1}{2}$ " d x 44" h SSGAR-11J0

Garrett Mule Chest Mirror

44 $\frac{3}{2}$ " w x 30 $\frac{3}{4}$ " h SMGAR-08A0

Features beveled edge mirror.

d Garrett 6-Drawer Chest

36" w x 18 $\frac{1}{2}$ " d x 52" h SSGAR-04F0

e Garrett Nightstand with Drawers

22" w x 18 $\frac{1}{2}$ " d x 27 $\frac{1}{2}$ " h SNGAR-02C1

f Garrett Nightstand with Opening on Bottom

22" w x 18 $\frac{1}{2}$ " d x 27 $\frac{1}{2}$ " h SNGAR-04A1

Available with multiple drawer configurations.

GEORGIA

SLEEP



This style comes standard with Wood Knobs (WK-A-01).

Nightstand shown with optional raised-panel sides.

M. Miller

SHOWN IN CHARACTER CHERRY, SPICE WITH OLDE WORLD AGING



a *Wood frame version available.*



b

a Georgia Panel Bed

Headboard: 54" h; Footboard: 33 1/4" h

CA King	78" w x 92" d	SBGEO-05B1
King	82" w x 88" d	SBGEO-05B2
Queen	66" w x 88" d	SBGEO-05B3
Full	60" w x 84" d	SBGEO-05B4
Twin	46" w x 84" d	SBGEO-05B5

Twin size design features a single panel

b Savannah Sleigh Bed

Headboard: 56" h; Footboard: 27 1/2" h

CA King	78" w x 94" d	SBSAV-09B1
King	82" w x 90" d	SBSAV-09B2
Queen	66" w x 90" d	SBSAV-09B3
Full	60" w x 86" d	SBSAV-09B4
Twin	46" w x 86" d	SBSAV-09B5

Twin size design features a single panel.

Not available with Under-Bed Storage

Solid Foundation

No box springs required — the mattress sits on a rigid plywood foundation.

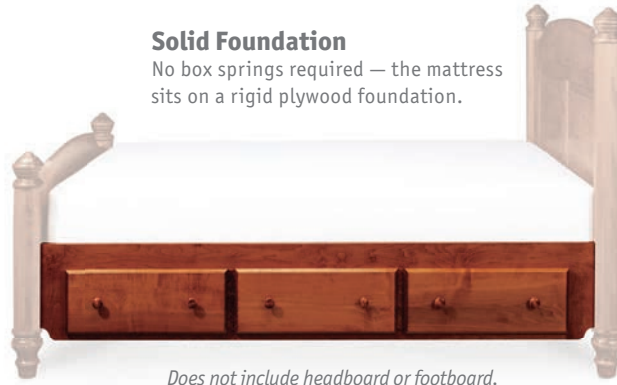

a

Does not include headboard or footboard.



b



c



d



e



f



g



h

a Georgia Under-Bed Storage

Rail Top: 20"; Rail Bottom: 5½" from floor. Mattress Sits 2" Lower than Rail Top

CA King	SSGRG-13A	🍃
King/Queen	SSGRG-13B	🍃
Full	SSGRG-13C	🍃
Twin	SSGRG-13D	🍃

Sold separately from the bed.

b Georgia 12-Drawer Bureau

60" w x 21½" d x 48" h MEGA43-60B
70" w x 21½" d x 48" h MEGA43-70B

Georgia Bureau Mirror

53¾" w x 27" h MEGASBM
63¾" w x 27" h MEGALBM

Features a beveled edge mirror.

c Georgia Mule Chest

54" w x 18½" d x 44½" h MEGA14MC

Georgia Mule Chest Mirror

44¾" w x 30" h MEMCM-GA

Features a beveled edge mirror.

d Georgia 7-Drawer Dresser

60" w x 21½" d x 34" h MEGA716D-60
70" w x 21½" d x 34" h MEGA716D-70

Georgia Dresser Mirror

40¾" w x 37" h MEGA30-M
50¾" w x 37" h MEGA30-L

Features a beveled edge mirror.

e Georgia 9-Drawer Chest

40" w x 21½" d x 56" h MEGA915CD

f Georgia 6-Drawer Chest

40" w x 21½" d x 49½" h MEGA15CD

g Georgia Nightstand with Drawers

23" w x 15½" d x 28" h MEGA19BC

Georgia Nightstand with Drawers, Extra Wide (Not Shown)

32" w x 18" d x 32" h SNGE0-02C4

Georgia Deluxe Nightstand with Drawers (Not Shown)

27" w x 18½" d x 34" h SNGE0-02C2

Features a pullout shelf.

h Georgia Nightstand with Opening

23" w x 15½" d x 28" h MEGA05NS

GRANT

SLEEP



This style comes standard with Darkened Hammered Brass Door Pulls (65-D-01) & Darkened Hammered Brass Drawer Pulls (65-D-02).

SHOWN IN QUARTERSAWN WHITE OAK, MICHAEL'S



a Wood frame version available.



b Wood frame version available.

a Grant Slat Bed with Stained Glass

Headboard: 61½" h; Footboard: 29½" h

CA King	85" w x 91" d	SBGRG-08B1
King	89" w x 87" d	SBGRG-08B2
Queen	73" w x 87" d	SBGRG-08B3
Full	67" w x 83" d	SBGRG-08B4
Twin	51" w x 83" d	SBGRG-08B5

b Grant Slat Bed

Headboard: 55½" h; Footboard: 29½" h

CA King	85" w x 91" d	SBGRA-08B1
King	89" w x 87" d	SBGRA-08B2
Queen	73" w x 87" d	SBGRA-08B3
Full	67" w x 83" d	SBGRA-08B4
Twin	53" w x 83" d	SBGRA-08B5

Solid Foundation

No box springs required — the mattress sits on a rigid plywood foundation.

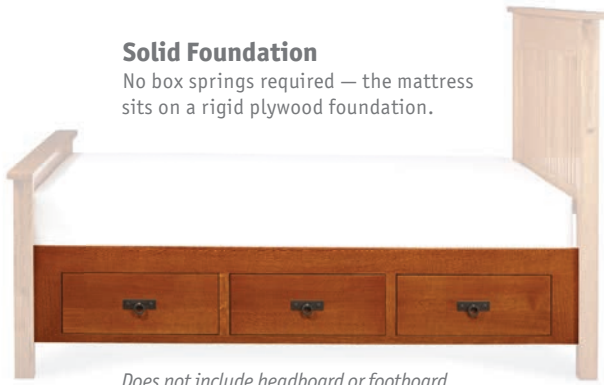

a *Does not include headboard or footboard.*

Red (standard) 	Cobalt Blue 	The main color block is red by default.
Dark Amber 	Hunter Green 	

When selecting the other choices only the main color block changes — the rest of the color panels remain the same.



b



c



d



e



f



g

a Grant Under-Bed Storage

Rail Top: 20"; Rail Bottom: 5½" from floor. Mattress Sits 2" Lower than Rail Top
CA King SSGRT-13A
King/Queen SSGRT-13B
Full SSGRT-13C
Twin SSGRT-13D

Sold separately from the bed.

b Grant Mule Chest

54" w x 18½" d x 44¾" h MEG14MC*

Grant Mule Chest Mirror with Stained Glass

46½" w x 35" h MEMCMS-GR

Features a beveled edge mirror.

Grant Mule Chest Mirror (Not Shown)

46½" w x 29" h MEMCM-GR

Features a beveled edge mirror.

c Grant 7-Drawer Dresser

60" w x 21½" d x 34" h MEG716D-60*

70" w x 21½" d x 34" h MEG716D-70*

Grant Dresser Mirror with Stained Glass

42½" w x 42" h MEG30S-M

52½" w x 42" h MEG30S-L

Features a beveled edge mirror.

Grant Dresser Mirror (Not Shown)

42½" w x 36" h MEG30-M

52½" w x 36" h MEG30-L

Features a beveled edge mirror.

d Grant 12-Drawer Bureau

60" w x 21½" d x 48" h MEG43-60B*

70" w x 21½" d x 48" h MEG43-70B*

Grant Bureau Mirror with Stained Glass

56" w x 32" h MEGSSBM

66" w x 32" h MEGSLBM

Features a beveled edge mirror.

Grant Bureau Mirror (Inset)

56" w x 26" h MEGSBM

66" w x 26" h MEGLBM

Features a beveled edge mirror.

e Grant 6-Drawer Chest

40" w x 21½" d x 55" h MEG15CD

f Grant Nightstand with Drawers

23" w x 15½" d x 29½" h MEG19BC

g Grant Nightstand with Doors

23" w x 15½" d x 29½" h MEG18NS

Features open space behind doors.

*Backslash standard if ordered without mirror.

Available with multiple drawer configurations.

NEW

HALEY

SLEEP



SHOWN IN SOFT MAPLE, PEBBLE WITH ANTIQUE WHITE TRIM



This style comes standard with Honey Bronze Pull (41-E-01).



Wood frame version available.

a

a Haley Bed

Headboard: 52" h; Footboard: 23 3/4" h
CA King 77" w x 90 1/4" d SBHAL-05B1
King 81" w x 86 1/4" d SBHAL-05B2
Queen 65" w x 86 1/4" d SBHAL-05B3
Full 59" w x 82 1/4" d SBHAL-05B4
Twin 44" w x 82 1/4" d SBHAL-05B5



a



b



c



d



e

a Haley 8-Drawer Dresser
60" w x 18 3/4" d x 51" h SSHAL-08H0
Haley 8-Drawer Dresser Mirror
50 1/4" w x 28" h SMHAL-06A2

b Haley 6-Drawer Dresser
60" w x 18 3/4" d x 39 3/4" h SSHAL-08F0
Haley 6-Drawer Dresser Mirror
47" w x 38" h SMHAL-13A2

c Haley 5-Drawer Chest
36 1/2" w x 18 3/4" d x 55 1/2" h SSHAL-04E0

d Haley 2-Drawer Nightstand (Not Shown)
24 1/4" w x 18 3/4" d x 27 3/4" h SNHAL-02B1
Haley 2-Drawer Nightstand, Extra Wide
30 3/4" w x 18 3/4" d x 27 3/4" h SNHAL-02B4

e Haley Nightstand with Shelf (Not Shown)
24 1/4" w x 18 3/4" d x 27 3/4" h SNHAL-10A1
Haley Nightstand with Shelf, Extra Wide
30 3/4" w x 18 3/4" d x 27 3/4" h SNHAL-10A4

HAMPTONS

SLEEP



This style comes standard with Weathered Nickel Ring Pull (80-B-13).

SHOWN IN OAK, CATTAIL, WIRE BRUSHED W/ INVERTED FOOTBOARD OPTION



Wood frame version available.

a



Inverted Footboard Option Available
Wood frame version available.

b

a Hamptons Panel Bed

Headboard: 53½" h; Footboard: 25¼" h
 CA King 76" w x 90½" d SBHAP-05B1
 King 80" w x 86½" d SBHAP-05B2
 Queen 64" w x 86½" d SBHAP-05B3
 Full 58" w x 82½" d SBHAP-05B4
 Twin 43" w x 82½" d SBHAP-05B5

b Hamptons Curved Panel Bed

Headboard: 53½" h; Footboard: 25¼" h
 CA King 75½" w x 89" d SBHAP-27B1
 King 79½" w x 85" d SBHAP-27B2
 Queen 63½" w x 85" d SBHAP-27B3
 Full 57½" w x 81" d SBHAP-27B4
 Twin 42½" w x 81" d SBHAP-27B5

Wood frame version available.



a



b

Shown with optional 1" canopy – SBHAP-O-CAN



c



d

a Hampton's Split Panel Bed

Headboard: 53¾" h; Footboard: 25¼" h;
 CA King 75½" w x 89" d SBHAP-29B1
 King 79½" w x 85" d SBHAP-29B2
 Queen 63½" w x 85" d SBHAP-29B3
 Full 57½" w x 81" d SBHAP-29B4
 Twin 42½" w x 81" d SBHAP-29B5

b Hampton's Panel Pencil Post Bed

Headboard: 53½" h;
 Footboard: 25¼" h Post: 80"
 CA King 76" w x 90½" d SBHAP-30B1
 King 80" w x 86½" d SBHAP-30B2
 Queen 64" w x 86½" d SBHAP-30B3
 Full 58" w x 82½" d SBHAP-30B4
 Twin 43" w x 82½" d SBHAP-30B5

c Hampton's Curved Pencil Post Bed

Headboard: 53½" h;
 Footboard: 25¼" h; Post: 80"
 CA King 75½" w x 89" d SBHAP-32B1
 King 79½" w x 85" d SBHAP-32B2
 Queen 63½" w x 85" d SBHAP-32B3
 Full 57½" w x 81" d SBHAP-32B4
 Twin 42½" w x 81" d SBHAP-32B5

d Hampton's Split Pencil Post Bed

Headboard: 50" h; Footboard: 22" h;
 Post: 80"
 CA King 75½" w x 89" d SBHAP-31B1
 King 79½" w x 85" d SBHAP-31B2
 Queen 63½" w x 85" d SBHAP-31B3
 Full 57½" w x 81" d SBHAP-31B4
 Twin 42½" w x 81" d SBHAP-31B5

Shown with optional canopy
 SBHAP-O-CAN



a



b



c



d

a Hamptons 5-Drawer Chest
44"w x 18"d x 48"h SSHAP-04E

b Hamptons 6-Drawer Chest
34"w x 18"d x 54"h SSHAP-04F

c Hamptons 8-Drawer Chest
60"w x 18"d x 44"h SSHAP-04H

d Hamptons 6-Drawer Dresser
60"w x 18"d x 37½"h SSHAP-08F

Shown with center leg.
Center leg is added to 72" Hamptons dressers and chests.



a



Extra Wide Version Shown b



c



d Extra Wide Version Shown

a Hamptons 8-Drawer Dresser
72" w x 18" d x 37½" h SSHAP-08H

b Hamptons 2-Drawer Nightstand
23" w x 18" d x 26" h SNHAP-02B1
1 pull per drawer.

Hamptons 2-Drawer Nightstand, Extra Wide
29" w x 18" d x 26" h SNHAP-02B4 (Shown)
2 pulls per drawer.

c Hamptons Nightstand with Shelf
23" w x 18" d x 26" h SNHAP-10A1 (Shown)
1 pull per drawer.

Hamptons Nightstand with Shelf, Extra Wide
29" w x 18" d x 26" h SNHAP-10A4
2 pulls per drawer.

d Hamptons Nightstand with Open Cubby
23" w x 18" d x 26" h SNHAP-08A1
1 pull per drawer.

Hamptons Nightstand with Open Cubby, Extra Wide
29" w x 18" d x 26" h SNHAP-08A4 (Shown)
2 pulls per drawer. Pullout — standard.

HOMESTEAD

SLEEP



M. Miller

SHOWN IN SOFT MAPLE, BUCKEYE



This style comes standard with Nickel Knobs (70-B-01).



Wood frame version available.

a



Wood frame version available.

b

a Stamford Bed

Headboard: 54" h; Footboard: 33" h

CA King	78½" w x 92" d	SBSTM-05B1
King	82½" w x 88" d	SBSTM-05B2
Queen	66½" w x 88" d	SBSTM-05B3
Full	60½" w x 84" d	SBSTM-05B4
Twin	45½" w x 84" d	SBSTM-05B5

b Homestead Raised Panel Bed

Headboard: 50" h; Footboard: 33" h

CA King	78½" w x 92" d	SBHME-05B1
King	82½" w x 88" d	SBHME-05B2
Queen	66½" w x 88" d	SBHME-05B3
Full	60½" w x 84" d	SBHME-05B4
Twin	45½" w x 84" d	SBHME-05B5



a

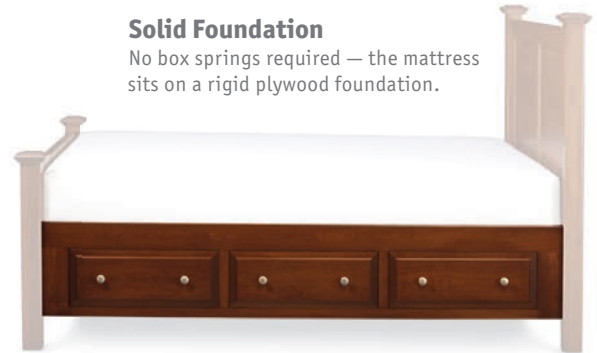

Solid Foundation

No box springs required — the mattress sits on a rigid plywood foundation.

b

Does not include headboard or footboard.



c



d

a Homestead Sleigh Bed

Headboard: 52" h; Footboard: 32" h

CA King	76" w x 98" d	SBHME-09B1
King	80" w x 94" d	SBHME-09B2
Queen	64" w x 94" d	SBHME-09B3
Full	58" w x 90" d	SBHME-09B4
Twin	44" w x 90" d	SBHME-09B5

b Homestead Under-Bed Storage

Rail Top: 20"; Rail Bottom: 5½" from floor. Mattress Sits 2" Lower than Rail Top

CA King	SSHME-13A
King/Queen	SSHME-13B
Full	SSHME-13C
Twin	SSHME-13D

Sold separately from the bed.

c Homestead 12-Drawer Bureau

58" w x 21¼" d x 47¾" h ME943-60B
69½" w x 21¼" d x 47¾" h ME943-70B

Shaker Bureau Mirror

52" w x 27¾" h MESBMS
62" w x 27¾" h MELBMS

Features a beveled edge mirror.

d Homestead Mule Chest

54" w x 18¼" d x 44½" h ME914MC

Shaker Mule Chest Mirror

42½" w x 30½" h MEMCM-SH

Features a beveled edge mirror.

Available with multiple drawer configurations.



a



b



c



d

a Homestead 7-Drawer Dresser

58" w x 21 1/4" d x 33 3/4" h ME9916D
 69 1/2" w x 21 1/4" d x 33 3/4" h ME9916-68

Shaker Tri-View Mirror

50 3/4" w x 41 1/2" h ME317TVS
 63 3/4" w x 41 1/2" h ME3130TVS

Features a beveled edge mirror.

b Homestead 6-Drawer Dresser

58" w x 21 1/4" d x 32 3/4" h ME916D
 69 1/2" w x 21 1/4" d x 33 3/4" h ME916-68D

Shaker Dresser Mirror

38 1/2" w x 37 1/2" h ME330DCS
 48 1/2" w x 37 1/2" h ME330-LS

Features a beveled edge mirror.

c Homestead 9-Drawer Chest

39" w x 21 1/4" d x 55" h ME9915CD

d Homestead 6-Drawer Chest

39" w x 21 1/4" d x 48 1/2" h ME915CD



a



b



c



d



e



f

a Homestead Wardrobe

41" w x 21 1/4" d x 72 3/4" h ME932WR

Features four adjustable shelves and three clothes rods.

b Homestead Tall Armoire on Chest

39" w x 21 1/4" d x 77" h ME9922AC-1

Features three adjustable shelves and a clothes rod.

c Homestead Chest on Chest

39" w x 21 1/4" d x 55 1/2" h ME9121CC

d Homestead Blanket Chest with False Fronts39 1/2" w x 19 1/2" d x 19 3/4" h ME937BC-**e Homestead Nightstand with Opening**

22 1/2" w x 15 3/4" d x 25 1/4" h ME905NS

f Homestead Nightstand with Drawers

22 1/2" w x 15 3/4" d x 25 1/4" h ME919BC

Homestead Deluxe Nightstand with Drawers (Not Shown)

26 1/2" w x 18 3/4" d x 31 1/4" h ME9919SBC

Features a pullout surface under the top.

 Available with fabric cushion seat or leather cushion seat. If using your own fabric please supply 2 yards. COM=Grade 3.

IMPERIAL

SLEEP



SHOWN IN CHERRY, AVALON.



This style comes standard with Wood Knobs (WK-A-01).



a



b

a Imperial Panel Bed

Headboard: 50½" h; Footboard: 27" h

CA King	82" w x 91" d	SBIM3-05B1
King	86" w x 87" d	SBIM3-05B2
Queen	70" w x 87" d	SBIM3-05B3
Full	64" w x 83" d	SBIM3-05B4
Twin	49" w x 83" d	SBIM3-05B5

b Imperial Sleigh Bed

Headboard: 55" h; Footboard: 27" h

CA King	76" w x 97" d	SBIMP-09B1
King	80" w x 93" d	SBIMP-09B2
Queen	64" w x 93" d	SBIMP-09B3
Full	58" w x 89" d	SBIMP-09B4
Twin	43" w x 89" d	SBIMP-09B5

Not available with Under-Bed Storage

Solid Foundation

No box springs required — the mattress sits on a rigid plywood foundation.



a Does not include headboard or footboard.



b



c



d



e



f

a Imperial Under-Bed Storage

Rail Top: 20"; Rail Bottom: 5½" from floor
Mattress Sits 2" Lower than Rail Top

- CA King SSIMP-13A
- King/Queen SSIMP-13B
- Full SSIMP-13C
- Twin SSIMP-13D

Sold separately from the bed.

b Imperial 9-Drawer Bureau

60" w x 21½" d x 48½" h MEI43-60B
70" w x 21½" d x 48½" h MEI43-70B

Imperial Bureau Mirror

56½" w x 28¾" h MEISBM
66½" w x 28¾" h MEILBM

Features a beveled edge mirror.

c Imperial 7-Drawer Dresser

60" w x 21½" d x 35½" h MEI716D-60
70" w x 21½" d x 35½" h MEI716D-70

Imperial Dresser Mirror

43" w x 38¾" h MEI30-M
53" w x 38¾" h MEI30-L

Features a beveled edge mirror.

e Imperial Deluxe Nightstand with Drawers

27" w x 18½" d x 33¾" h MEI19SBC

Features a pullout surface under the top.

f Imperial Deluxe Nightstand with Opening

27" w x 18½" d x 33¾" h MEI05SNS

Features a pullout surface under the top.

d Imperial 3-Drawer Wardrobe

43½" w x 22¼" d x 72½" h MEI38WR3

Interior: 33½" w x 20½" d x 32½" h

Features two adjustable shelves.

Available with multiple drawer configurations.

IRONWOOD

SLEEP



SHOWN IN SOFT MAPLE, BARNBOARD; WIRE BRUSHED WITH 5° SHEEN



This style comes standard with Brushed Satin Nickel Pull (70-E-34).



a

Uses standard slats.



b

Includes entire bed.

a Ironwood Planked Bed

Headboard: 54" h; Footboard: 14½" h

CA King	77½" w x 87½" d	SBIRN-23B1
King	81½" w x 83½" d	SBIRN-23B2
Queen	65½" w x 83½" d	SBIRN-23B3
Full	59½" w x 79½" d	SBIRN-23B4
Twin	44½" w x 79½" d	SBIRN-23B5

Slats are 11½" off floor (3" below top of rail).

b Ironwood Planked Storage Bed

Headboard: 54" h; Footboard: 14½" h

CA King	77½" w x 87½" d	SBIRN-26S1
King	81½" w x 83½" d	SBIRN-26S2
Queen	65½" w x 83½" d	SBIRN-26S3
Full	59½" w x 79½" d	SBIRN-26S4
Twin	44½" w x 79½" d	SBIRN-26S5



a



b



c



d



e



f



g

a Ironwood 8-Drawer Dresser

62½" w x 19¼" d x 38½" h SSIRN-08H2
72½" w x 19¼" d x 38½" h SSIRN-08H3

b Ironwood 6-Drawer Dresser

62½" w x 19¼" d x 30" h SSIRN-08F2
72½" w x 19¼" d x 30" h SSIRN-08F3

d Ironwood 3-Drawer Nightstand

22" w x 19¼" d x 25" h SNIRN-02C1

f Ironwood Nightstand with Opening

22" w x 19¼" d x 25" h SNIRN-09A1

c Ironwood 5-Drawer Chest

32½" w x 19¼" d x 46½" h SSIRN-04E0

e Ironwood 3-Drawer Nightstand, Extra Wide

30" w x 19¼" d x 25" h SNIRN-02C4

g Ironwood Nightstand with Opening, Extra Wide

30" w x 19¼" d x 25" h SNIRN-09A4

JUSTINE

SLEEP



S. Kauffman

SHOWN IN CHERRY, GOLD DUST



This style comes standard with Nickel Pulls (70-B-20).



a

Wood frame version available.
Available with upholstered headboard option.



b

Includes entire bed.

a Justine Panel Bed

Headboard: 54" h; Footboard: 28½" h

CA King	77" w x 91" d	SBJUS-05B1
King	81" w x 87" d	SBJUS-05B2
Queen	65" w x 87" d	SBJUS-05B3
Full	59" w x 83" d	SBJUS-05B4
Twin	45" w x 83" d	SBJUS-05B5

b Justine Panel Bed with Footboard Storage

Headboard: 54" h; Footboard: 18½" h

CA King	76½" w x 90" d	SBJUS-05F1
King	80½" w x 86" d	SBJUS-05F2
Queen	64½" w x 86" d	SBJUS-05F3
Full	58½" w x 82" d	SBJUS-05F4
Twin	43½" w x 82" d	SBJUS-05F5

Twin bed comes with only one drawer.



a

Shown with optional under-bed storage



b

Wood frame version available.



c

Solid Foundation

No box springs required — the mattress sits on a rigid plywood foundation.



d

Does not include headboard or footboard.

a Justine Panel Platform Bed

Headboard: 41" h; Platform: 8" h

CA King	80" w x 91" d	SBJUS-05P1
King	84" w x 87" d	SBJUS-05P2
Queen	68" w x 87" d	SBJUS-05P3
Full	62" w x 83" d	SBJUS-05P4
Twin	47" w x 83" d	SBJUS-05P5

Not available with Under-Bed Storage
Rolled Slats Standard.

b Justine Bookcase Bed

Headboard: 54" h; Footboard: 13½" h

CA King	76" w x 96" d	SBJUS-01W1
King	80" w x 92" d	SBJUS-01W2
Queen	64" w x 92" d	SBJUS-01W3
Full	58" w x 88" d	SBJUS-01W4
Twin	43" w x 88" d	SBJUS-01W5

c Justine Slat Bed

Headboard: 53" h; Footboard: 29" h

CA King	77" w x 89" d	SBJUS-08B1
King	81" w x 85" d	SBJUS-08B2
Queen	65" w x 85" d	SBJUS-08B3
Full	59" w x 81" d	SBJUS-08B4
Twin	45" w x 81" d	SBJUS-08B5

d Justine Under-Bed Storage

Rail Top: 20"; Rail Bottom: 5½" from floor; Mattress Sits 2" lower than Rail Top

CA King	SSJUS-13A
King/Queen	SSJUS-13B
Full	SSJUS-13C
Twin	SSJUS-13D

Sold separately from the bed.



a



b



c



d



e

a Justine 12-Drawer Bureau
 60" w x 21 3/4" d x 48 3/4" h MEJ43-60B
 70" w x 21 3/4" d x 48 3/4" h MEJ43-70B

Justine Bureau Mirror
 51 3/4" w x 28" h MEJSBM
 61 3/4" w x 28" h MEJLBM

Features a beveled edge mirror.

b Justine 7-Drawer Dresser
 60" w x 21 3/4" d x 34" h MEJ716D-60
 70" w x 21 3/4" d x 34" h MEJ716D-70

Justine Dresser Mirror
 38" w x 38" h MEJ30-M
 48" w x 38" h MEJ30-L

Features a beveled edge mirror.

c Justine Mule Chest
 54" w x 18 3/4" d x 44 1/2" h MEJ14MC

Justine Mule Chest Mirror
 42" w x 31" h MEMCM-JU

Features a beveled edge mirror.

d Justine Door Chest
 48" w x 21 3/4" d x 64 1/2" h MEJ44DC

Features four adjustable shelves, two clothes rods and a mirror on the back of left side door.

e Justine 9-Drawer Chest
 40" w x 21 3/4" d x 56 1/2" h MEJ915CD



a



b



c



d



e

a Justine Nightstand with Drawers
23" w x 15³/₄" d x 28" h MEJ19BC

b Justine Nightstand Table
24" w x 18" d x 28³/₄" h KAJBT

c Justine Open Nightstand
24" w x 18" d x 28" h SNJUS-05E1

d Justine Nightstand with Opening
23" w x 15³/₄" d x 28" h MEJ05NS

e Justine Nightstand with Drawers, Extra Wide
32" w x 18" d x 32" h SNJUS-02C4

NEW

KODIAK

SLEEP



SHOWN IN CHARACTER CHERRY, BOURBON WITH OLDE WORLD AGING



This style comes standard with Black Pull (68-B-18).



Wood frame version available.

a



Features metal accents.

a Kodiak Bed

Headboard: 54" h; Footboard: 26" h

CA King	76 $\frac{3}{4}$ " w x 90" d	SBKOD-05B1
King	80 $\frac{3}{4}$ " w x 86" d	SBKOD-05B2
Queen	64 $\frac{3}{4}$ " w x 86" d	SBKOD-05B3
Full	58 $\frac{3}{4}$ " w x 82" d	SBKOD-05B4
Twin	43 $\frac{3}{4}$ " w x 82" d	SBKOD-05B5



a



b



c

a Kodiak 8-Drawer Bureau

59½" w x 21¾" d x 47" h SSKOD-03H2
69½" w x 21¾" d x 47" h SSKOD-03H3

Kodiak Bureau Mirror

52¼" w x 27¾" h SMKOD-01A2
62¼" w x 27¾" h SMKOD-01A3

b Kodiak 5-Drawer Chest

41" w x 21¾" d x 53¼" h SSKOD-04E0

c Kodiak Nightstand with Drawers, Extra Wide

32" w x 18¾" d x 31¼" h SNKOD-02C4

Kodiak Nightstand with Drawers (Not Shown)

26" w x 18¾" d x 31¼" h SNKOD-02C1

LOFT SLEEP



M. Miller

SHOWN IN CHERRY, BOURBON



This style comes standard with Nickel Pulls (70-E-10).



a

Wood frame version available.
Available with upholstered headboard option.



b



Wood frame version available.
Available with upholstered headboard option.

a Loft Panel Bed

Headboard: 55" h; Footboard: 25" h

CA King	81" w x 92" d	SBLFT-05B1
King	85" w x 88" d	SBLFT-05B2
Queen	69" w x 88" d	SBLFT-05B3
Full	63" w x 84" d	SBLFT-05B4
Twin	48" w x 84" d	SBLFT-05B5

b Loft II Panel Bed

Headboard: 55" h; Footboard: 33" h

CA King	78 3/4" w x 89" d	SBLF2-05B1
King	82 3/4" w x 85" d	SBLF2-05B2
Queen	66 3/4" w x 85" d	SBLF2-05B3
Full	60 3/4" w x 81" d	SBLF2-05B4
Twin	45 3/4" w x 81" d	SBLF2-05B5



Available with upholstered headboard option.



a

Wood frame version available.



b



c

Solid Foundation

No box springs required — the mattress sits on a rigid plywood foundation.



d

Does not include headboard or footboard.

a Loft II Panel Headboard with Wood Frame

Headboard: 55" h; Footboard: 13½" h
CA King 78¾" w x 89" d SBLF2-05W1
King 82¾" w x 85" d SBLF2-05W2
Queen 66¾" w x 85" d SBLF2-05W3
Full 60¾" w x 81" d SBLF2-05W4
Twin 45¾" w x 81" d SBLF2-05W5

b Loft Slat Bed

Headboard: 55" h; Footboard: 33" h
CA King 78¾" w x 89" d SBLFT-10B1
King 82¾" w x 85" d SBLFT-10B2
Queen 66¾" w x 85" d SBLFT-10B3
Full 60¾" w x 81" d SBLFT-10B4
Twin 45¾" w x 81" d SBLFT-10B5

c Loft II Panel Bed with Footboard Storage

Headboard: 55" h; Footboard: 18½" h
CA King 79" w x 87½" d SBLF2-05F1
King 83" w x 83½" d SBLF2-05F2
Queen 67" w x 83½" d SBLF2-05F3
Full 61" w x 79½" d SBLF2-05F4
Twin 46" w x 79½" d SBLF 2-05F5

d Loft Under-Bed Storage

Rail Top: 20"; Rail Bottom: 5½" from floor. Mattress Sits 2" Lower than Rail Top
CA King SSLFT-13A

King/Queen SSLFT-13B

Full SSLFT-13C

Twin SSLFT-13D

Sold separately from the bed.
(Not available on Express Beds)

Available with multiple drawer configurations.



EXPRESS



QUICKSHIP

simplyamish

LOFT

95



a



b



c



d



e

a Loft TV Bureau

60" w x 21½" d x 47¾" h MEL43-60TVB

70" w x 21½" d x 47¾" h MEL43-70TVB

Door area: 19" w x 19¾" d x 13½" h

Features one adjustable shelf behind door.

b Loft 12-Drawer Bureau 

60" w x 21½" d x 47¾" h MEL43-60B

70" w x 21½" d x 47¾" h MEL43-70B

Loft Bureau Mirror 

54½" w x 27" h MELSBM

64½" w x 27" h MELLBM

Features a beveled edge mirror.

c Loft Mule Chest

54" w x 18½" d x 44¾" h MEL314MC

Loft Mule Chest Mirror

45" w x 30" h MEMCM-LF

Features a beveled edge mirror.

d Loft 7-Drawer Dresser

60" w x 21½" d x 33¾" h MEL716D

70" w x 21½" d x 33¾" h MEL716D-70

Loft Dresser Mirror

41" w x 37" h MEL30-M

51" w x 37" h MEL30-L

Features a beveled edge mirror.

e Loft 3-Drawer Wardrobe

40½" w x 21½" d x 71¾" h MEL38WR3

Features two adjustable shelves and a clothes rod.



a

b

c

d



e



f



g



h



i

a Loft 9-Drawer Chest

40½" w x 21½" d x 55¾" h MEL915CD

b Loft 6-Drawer Chest

40" w x 21½" d x 49" h MEL15CD

c Loft Lingerie Chest

23" w x 18½" d x 49¾" h MEL29LC

d Loft Blanket Chest with False Fronts

40" w x 20" d x 19¾" h MEL37BC-

e Loft Nightstand with Drawers

23" w x 15½" d x 28¾" h MEL19BC

f Loft Nightstand Table

24" w x 18" d x 28" h MEL20BT

g Loft Nightstand with Doors

23" w x 15½" d x 28¾" h MEL18NS

Features open space behind doors.

Loft Deluxe Nightstand with Doors

(Not Shown)

27" w x 18½" d x 32" h MEL18SNS

Features a pullout surface under the top and one adjustable shelf behind doors.

h Loft Nightstand with Opening

23" w x 15½" d x 28¾" h MEL05NS

i Loft Deluxe Nightstand with Drawers

27" w x 18½" d x 32" h MEL19SBC

Features a pullout surface under the top.

Loft Nightstand with Drawers, Extra Wide

(not shown)

32" w x 18" d x 32" h SNLFT-02C4

Available with wood seat, fabric cushion seat, or leather cushion seat. If using your own fabric please supply 2 yards. COM=Grade 3.

LOUIS PHILIPPE

SLEEP



SHOWN IN CHERRY, BOURBON



This style comes standard with Dark Antique Brass knobs (63-A-01).



a

Wood frame version available.



b



c

a Louis Philippe Panel Bed

Headboard: 55" h; Footboard: 27" h

CA King	80" w x 93" d	SBLPP-05B1
King	84" w x 89" d	SBLPP-05B2
Queen	68" w x 89" d	SBLPP-05B3
Full	62" w x 85" d	SBLPP-05B4
Twin	48" w x 85" d	SBLPP-05B5

b Louis Philippe Sleigh Bed

Headboard: 50½" h; Footboard: 25½" h

CA King	77" w x 96" d	SBLPP-09B1
King	81" w x 92" d	SBLPP-09B2
Queen	65" w x 92" d	SBLPP-09B3
Full	59" w x 88" d	SBLPP-09B4
Twin	45" w x 88" d	SBLPP-09B5

Not available with Under-Bed Storage

c Louis Philippe Sleigh Bed with Low Footboard

Headboard: 50½" h; Footboard: 18¾" h

CA King	77" w x 96" d	SBLPP-09L1
King	81" w x 92" d	SBLPP-09L2
Queen	65" w x 92" d	SBLPP-09L3
Full	59" w x 88" d	SBLPP-09L4
Twin	45" w x 88" d	SBLPP-09L5

Not available with Under-Bed Storage

Solid Foundation

No box springs required — the mattress sits on a rigid plywood foundation.

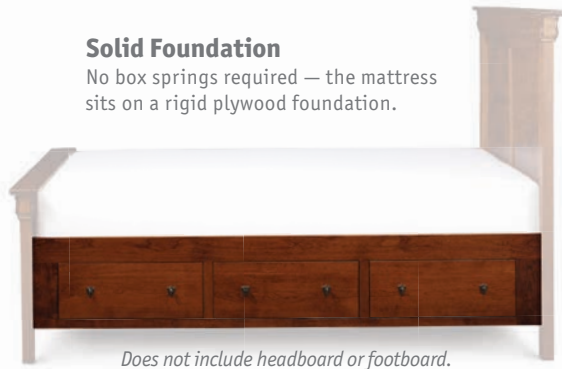

Does not include headboard or footboard.

a

Keeping your secrets safe.

Perhaps not surprisingly for furniture named after a man who spent much of his life on the run, the Louis Philippe Collection features secret drawers with felt-lined bottoms on all cabinets under 55" tall.



b



c



d



e



f



g



h



i

a Louis Philippe Under-Bed Storage

Rail Top: 20"; Rail Bottom: 5½" from floor. Mattress Sits 2" Lower than Rail Top

CA King SSLPP-13A
King/Queen SSLPP-13B
Full SSLPP-13C
Twin SSLPP-13D

Sold separately from the bed.

b Louis Philippe Mule Chest

54"w x 20"d x 44"h MELP14MC

Features three secret drawers.

Louis Philippe Mule Chest Mirror

44"w x 34"h MEMCM-LP

Features a beveled edge mirror.

c Louis Philippe 9-Drawer Bureau

62"w x 22"d x 48"h MELP43-60B

72"w x 22"d x 48"h MELP43-70B

Features three secret drawers.

Louis Philippe Bureau Mirror

54"w x 31"h MELPSBM

64"w x 31"h MELPLBM

Features a beveled edge mirror.

d Louis Philippe 7-Drawer Dresser

62"w x 22"d x 36"h MELP716D-60

72"w x 22"d x 36"h MELP716D-70

Features three secret drawers.

Louis Philippe Dresser Mirror

40"w x 41"h MELP30-M

50"w x 41"h MELP30-L

Features a beveled edge mirror.

e Louis Philippe Door Chest

50"w x 22"d x 68"h MELP44DC

Features four adjustable shelves, two clothes rods and a mirror on the back of left side door.

f Louis Philippe 6-Drawer Chest

42"w x 22"d x 54"h MELP15CD

Features two secret drawers.

g Louis Philippe Lingerie Chest

22"w x 20"d x 54"h MELP29LC

Features a secret drawer.

h Louis Philippe Nightstand with Drawers

24"w x 16"d x 28"h MELP19BC

Features a secret drawer.

i Louis Philippe Deluxe Nightstand with Drawers

32"w x 20"d x 34"h MELP19SBC

Features a secret drawer.

MÄRYAN

SLEEP



SHOWN IN CHARACTER CHERRY, BOURBON



This style comes standard with German Bronze Pulls (94-D-01).



a

Wood frame version available.



b

Wood frame version available.

a MäRyAn Panel Bed

Headboard: 59 $\frac{3}{4}$ "h; Footboard: 32" h

CA King	83" w x 95" d	SBMRY-05B1
King	87" w x 91" d	SBMRY-05B2
Queen	71" w x 91" d	SBMRY-05B3
Full	65" w x 87" d	SBMRY-05B4
Twin	50" w x 87" d	SBMRY-05B5

b MäRiA Bed

Headboard: 65 $\frac{3}{4}$ "h; Footboard: 31 $\frac{3}{4}$ " h

CA King	82 $\frac{3}{4}$ " w x 95" d	SBMAR-05B1
King	86 $\frac{3}{4}$ " w x 91" d	SBMAR-05B2
Queen	70 $\frac{3}{4}$ " w x 91" d	SBMAR-05B3
Full	64 $\frac{3}{4}$ " w x 87" d	SBMAR-05B4
Twin	50 $\frac{3}{4}$ " w x 87" d	SBMAR-05B5

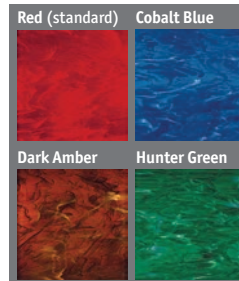

The main color block is red by default.

When selecting the other choices only the main color block changes — the rest of the color panels remain the same.

Solid Foundation

No box springs required — the mattress sits on a rigid plywood foundation.



a Does not include headboard or footboard.

Wood frame version available.



b

Wood frame version available.



c



d



e



f

a MäRyän Under-Bed Storage

Rail Top: 20"; Rail Bottom: 5½" from floor
Mattress Sits 2" Lower than Rail Top

CA King	SSMRY-13A
King/Queen	SSMRY-13B
Full	SSMRY-13C
Twin	SSMRY-13D

Sold separately from the bed.

b MäKayla Bed

Headboard: 65¾"h; Footboard: 31¾"h

CA King	83"w x 94"d	SBMAK-05B1
King	87"w x 90"d	SBMAK-05B2
Queen	71"w x 90"d	SBMAK-05B3
Full	65"w x 86"d	SBMAK-05B4
Twin	51"w x 86"d	SBMAK-05B5

c Ryan Slat Bed

Headboard: 60"h; Footboard: 32"h

CA King	83"w x 95"d	SBRYN-08B1
King	87"w x 91"d	SBRYN-08B2
Queen	71"w x 91"d	SBRYN-08B3
Full	67"w x 87"d	SBRYN-08B4
Twin	51"w x 87"d	SBRYN-08B5

d MäRyän Bookcase Bed

Headboard: 54"h; Footboard: 14"h

CA King	83"w x 97"d	SBMRY-01B1
King	87"w x 93"d	SBMRY-01B2
Queen	71"w x 93"d	SBMRY-01B3
Full	65"w x 89"d	SBMRY-01B4
Twin	50"w x 89"d	SBMRY-01B5

e MäKayla Grande Bed

Headboard: 72"h; Footboard: 39"h

CA King	86¾"w x 101"d	SBMKG-05B1
King	90¾"w x 97"d	SBMKG-05B2
Queen	74¾"w x 97"d	SBMKG-05B3

f MäKayla Grande Poster Bed

Headboard: 79"h; Footboard: 79"h

CA King	86¾"w x 101"d	SBMKG-07B1
King	90¾"w x 97"d	SBMKG-07B2
Queen	74¾"w x 97"d	SBMKG-07B3



a



b



c

- a MäRyan 12-Drawer Bureau**
 64" w x 25" d x 50" h NWM43-64B
 74" w x 25" d x 50" h NWM43-72B
 Features three secret drawers.
MäRyan Bureau Mirror
 62" w x 5" d x 30" h NWMSBM
 72" w x 5" d x 30" h NWMLBM
 Features a beveled edge mirror.

- b MäRyan Mule Chest**
 62" w x 22" d x 44 3/4" h NWM14MC
 Features three secret drawers.
MäRyan Mule Chest Mirror
 52 1/2" w x 5" d x 33" h NWMCM-MR
 Features a beveled edge mirror.

- c MäRyan 9-Drawer Dresser**
 74" w x 25" d x 35" h NWM216DD9
 Features three secret drawers.
MäRyan Dresser Mirror
 58" w x 5" d x 40" h NWM30-L
 Features a beveled edge mirror.

Keeping your secrets safe.

The MäRyan Collection features secret drawers with felt-lined bottoms on all cabinets under 55" tall.



a



b



c



d



e



f

a MäRyan Door Chest

59"w x 25"d x 68¾"h NWM44DC

Features four adjustable shelves and two clothes rods.

b MäRyan 5-Drawer Chest

46"w x 25"d x 54"h NWM07CD

Features two secret drawers.

c MäRyan Lingerie Chest

31"w x 22"d x 55"h NWM29LC

Features a secret drawer.

d MäKayla Nightstand Table

24"w x 18"d x 28¼"h TVM2418BSD

Features a secret drawer.

e MäRyan Nightstand with Drawers

28"w x 20"d x 33"h NWM19BC

Features a secret drawer.

f MäRyan Deluxe Nightstand with Drawers

32"w x 20"d x 33"h NWM19DBC

Features a secret drawer.

McCOY

SLEEP



S. Kauffman

SHOWN IN QUARTERSAWN WHITE OAK, MICHAEL'S

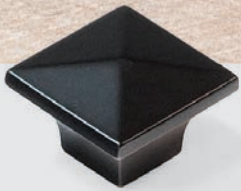

This style comes standard with Black Metal Knobs (WK-A-07).



a McCoy Panel Bed

Headboard: 49½" h; Footboard: 28" h

CA King	78½" w x 96" d	SBMCC-05B1
King	82½" w x 92" d	SBMCC-05B2
Queen	66½" w x 92" d	SBMCC-05B3
Full	60½" w x 88" d	SBMCC-05B4
Twin	45½" w x 88" d	SBMCC-05B5

b McCoy Panel Headboard with Wood Frame

Headboard: 49½" h; Footboard: 14" h

CA King	78½" w x 90½" d	SBMCC-05W1
King	82½" w x 86½" d	SBMCC-05W2
Queen	66½" w x 86½" d	SBMCC-05W3
Full	60½" w x 82½" d	SBMCC-05W4
Twin	45½" w x 82½" d	SBMCC-05W5



Solid Foundation

No box springs required — the mattress sits on a rigid plywood foundation.

a

Does not include headboard or footboard.



b



c



d

a McCoy Under-Bed Storage

Rail Top: 20"; Rail Bottom: 5½" from floor. Mattress Sits 2" Lower than Rail Top

- CA King SSMCC-13A
- King/Queen SSMCC-13B
- Full SSMCC-13C
- Twin SSMCC-13D

Sold separately from the bed.
(Not available on Express Beds)

b McCoy Mule Chest

54"w x 20½"d x 43½"h MEM14MC

McCoy Mule Chest Mirror

48¾"w x 4½"d x 29¾"h MEMCM-MC

Features a beveled edge mirror.

c McCoy 12-Drawer Bureau

62"w x 23½"d x 48½"h MEM43-62
72"w x 23½"d x 48½"h MEM43-72

McCoy Bureau Mirror

57¾"w x 27"h MEMSBM
67¾"w x 27"h MEMLBM

Features a beveled edge mirror.

d McCoy 7-Drawer Dresser

62"w x 23½"d x 33½"h MEM167D
72"w x 23½"d x 33½"h MEM167D-72

McCoy Dresser Mirror

44¾"w x 36¾"h MEM30-M
54¾"w x 36¾"h MEM30-LM

Features a beveled edge mirror.

Available with multiple drawer configurations.



EXPRESS



QUICKSHIP

simplyamish

McCOY

105



a

b

c



d



e



f

a McCoy Door Chest

52" w x 23½" d x 63¾" h MEM44DC
 Door Openings: 12¾" w x 20¾" d x 63¾" h

Features four adjustable shelves, two clothes rods and a mirror on the back of left side door.

b McCoy Wardrobe

44¾" w x 24¾" d x 72" h MEM32WR
 Openings: 15½" w x 20¾" d x 54" h

Features four adjustable shelves and 3 clothes rods.

c McCoy 9-Drawer Chest

42" w x 23½" d x 57¾" h MEM915CD

d McCoy 6-Drawer Chest

42" w x 23½" d x 50¼" h MEM15CD

e McCoy Lingerie Chest

23½" w x 20½" d x 50¼" h MEM29LC

f McCoy Blanket Chest with False Fronts

42" w x 21½" d x 20" h MEM37BC

Available with fabric cushion seat or leather cushion seat. If using your own fabric please supply 2 yards. COM=Grade 3.

**a McCoy Nightstand with Doors**22 $\frac{3}{4}$ "w x 17 $\frac{1}{2}$ "d x 28"h MEM18NS

Features open space behind doors.

b McCoy Nightstand with Drawers 22 $\frac{3}{4}$ "w x 17 $\frac{1}{2}$ "d x 28"h MEM19BC**c McCoy Nightstand with Opening**22 $\frac{3}{4}$ "w x 17 $\frac{1}{2}$ "d x 28"h MEM05NS**d McCoy Deluxe Nightstand with Doors**26"w x 20 $\frac{1}{2}$ "d x 32"h MEM18DNS

Features a pullout surface under the top and one adjustable shelf behind the doors.

e McCoy Deluxe Nightstand with Drawers26"w x 20 $\frac{1}{2}$ "d x 32"h MEM19DBC

Features a pullout surface under the top.

f McCoy Deluxe Nightstand with Opening26"w x 20 $\frac{1}{2}$ "d x 32"h MEM05DNS

Features a pullout surface under the top.

g McCoy Nightstand with Drawers, Extra Wide

32"w x 18"d x 32"h SNMCC-02C4



EXPRESS



QUICKSHIP

simplyamish

McCOY

107

MONARCH

SLEEP



S. Kauff

SHOWN IN CHERRY, GOLD DUST



This style comes standard with Nickel Pulls (70-D-24).



Wood frame version available.

a



Wood frame version available.

b

a Monarch Panel Bed

Headboard: 60"h; Footboard: 33"h

CA King	76½"w x 89½"d	SBMON-05B1
King	80½"w x 85½"d	SBMON-05B2
Queen	64½"w x 85½"d	SBMON-05B3
Full	58½"w x 81½"d	SBMON-05B4
Twin	44½"w x 81½"d	SBMON-05B5

b Monarch II Panel Bed

Headboard: 60"h; Footboard: 33"h

CA King	76½"w x 89½"d	SBM02-05B1
King	80½"w x 85½"d	SBM02-05B2
Queen	64½"w x 85½"d	SBM02-05B3
Full	58½"w x 81½"d	SBM02-05B4
Twin	44½"w x 81½"d	SBM02-05B5

Solid Foundation

No box springs required — the mattress sits on a rigid plywood foundation.

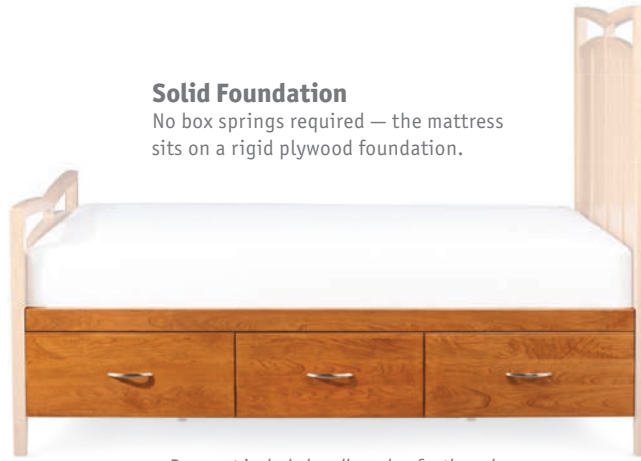

a

Does not include headboard or footboard.



b



c



d

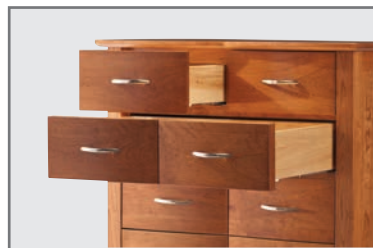

The top row of drawers on the chest are separated into two drawers, while the remainder of the rows are combined into one drawer.



e

a Monarch Under-Bed Storage

Rail Top: 20"; Rail Bottom: 5½" from floor. Mattress Sits 2" Lower than Rail Top

- CA King SSMON-13A
- King/Queen SSMON-13B
- Full SSMON-13C
- Twin SSMON-13D

Sold separately from the bed.

b Monarch 12-Drawer Bureau

60"w x 22¾"d x 49"h SSMON-03M2
70"w x 22¾"d x 49"h SSMON-03M3

Monarch Bureau Mirror

48"w x 34"h SMMON-01A2
58"w x 34"h SMMON-01A3

Features a beveled edge mirror.

c Monarch 6-Drawer Dresser

60"w x 22¾"d x 34¾"h SSMON-08F2
70"w x 22¾"d x 34¾"h SSMON-08F3

Monarch Dresser Mirror

36"w x 39"h SMMON-06A2
46"w x 39"h SMMON-06A3

Features a beveled edge mirror.

d Monarch 6-Drawer Chest

42"w x 22¾"d x 51¾"h SSMON-04F0

e Monarch Nightstand with Drawers

26"w x 20½"d x 32½"h SNMON-02C1

MONTAUK

SLEEP



This style comes standard with Flat Black Pull (68-C-11).

SHOWN IN SOFT MAPLE, BARNBOARD WITH ROUGH SAWN (STANDARD)



a



b

Includes entire bed.

a Montauk 2-Panel Bed

Headboard: 58" h; Footboard: 26" h;
Rough Sawn Standard

CA King	78½" w x 87½" d	SBMOK-21B1
King	82½" w x 83½" d	SBMOK-21B2
Queen	66½" w x 83½" d	SBMOK-21B3
Full	60½" w x 79½" d	SBMOK-21B4
Twin	45½" w x 79½" d	SBMOK-21B5

b Montauk 2-Panel Bed with Footboard Storage

Headboard: 58" h; Rough Sawn Standard

CA King	78½" w x 87½" d	SBMOK-21F1
King	82½" w x 83½" d	SBMOK-21F2
Queen	66½" w x 83½" d	SBMOK-21F3
Full	60½" w x 79½" d	SBMOK-21F4
Twin	45½" w x 79½" d	SBMOK-21F5

Twin bed comes with only one drawer.

Solid Foundation

No box springs required — the mattress sits on a rigid plywood foundation.



a

Does not include headboard or footboard.



b



c



d



e



f



g



h

a Montauk Under-Bed Storage

Rail Top: 18"; Rail Bottom: 5½" from floor
 Mattress Sits 2½" Lower than Rail Top;
 Rough Sawn Standard

CA King SSMOK-18A4 2 Drawers Ea. Side
 King/Queen SSMOK-18B4 2 Drawers Ea. Side
 Full SSMOK-18C4 2 Drawers Ea. Side
 Twin SSMOK-18D4 2 Drawers Ea. Side
 Twin SSMOK-18D2 2 Drawers One Side

Sold separately from the bed.

b Montauk 5-Drawer Chest

Rough Sawn & Plank Top Standard
 36" w x 18¾" d x 55" h SSMOK-04E0

c Montauk 8-Drawer Dresser

Rough Sawn & Plank Top Standard
 62" w x 18¾" d x 45¾" h SSMOK-08H2
 72" w x 18¾" d x 45¾" h SSMOK-08H3

Montauk 8-Drawer Dresser Mirror

Rough Sawn Standard
 50½" w x 26¼" h SMMOK-06B1
 60½" w x 26¼" h SMMOK-06B2

d Montauk 6-Drawer Dresser

Rough Sawn & Plank Top Standard
 62" w x 18¾" d x 36" h SSMOK-08F2
 72" w x 18¾" d x 36" h SSMOK-08F3

Montauk 6-Drawer Dresser Mirror

Rough Sawn Standard (Not Shown)
 37" w x 36¼" h SMMOK-13B1
 47" w x 36¼" h SMMOK-13B2

e Montauk Nightstand with Opening

Rough Sawn & Plank Top Standard
 22" w x 18¾" d x 28" h SNMOK-09A1

f Montauk Nightstand with Opening, Extra Wide

Rough Sawn & Plank Top Standard
 30" w x 18¾" d x 28" h SNMOK-09A4

g Montauk 3-Drawer Nightstand

Rough Sawn & Plank Top Standard
 22" w x 18¾" d x 28" h SNMOK-02C1

h Montauk 3-Drawer Nightstand, Extra Wide

Rough Sawn & Plank Top Standard
 30" w x 18¾" d x 28" h SNMOK-02C4

NEW

MONTGOMERY

SLEEP



SHOWN IN SOFT MAPLE, DRIFTWOOD



This style comes standard with
Ash Gray Pull (83-E-01).



a

a Montgomery Bed

Headboard: 60" h; Footboard: 26½" h

CA King	78" w x 91" d	SBMTG-05B1
King	82" w x 87" d	SBMTG-05B2
Queen	66" w x 87" d	SBMTG-05B3
Full	60" w x 83" d	SBMTG-05B4
Twin	45" w x 83" d	SBMTG-05B5



a



b



c



d



e

a Montgomery 8-Drawer Dresser

59½" w x 19" d x 45½" h SSMTG-08H2
 69½" w x 19" d x 45½" h SSMTG-08H3

Montgomery 8-Drawer Dresser Mirror

42½" w x 30¼" h SMMTG-06A2
 52½" w x 30¼" h SMMTG-06A3

b Montgomery 6-Drawer Dresser

59½" w x 19" d x 37¾" h SSMTG-08F2
 69½" w x 19" d x 37¾" h SSMTG-08F3

Montgomery 6-Drawer Dresser Mirror (Not Shown)

36½" w x 38" h SMMTG-13A2
 46½" w x 38" h SMMTG-13A3

c Montgomery 5-Drawer Chest

40" w x 19" d x 50" h SSMTG-04E0

d Montgomery 2-Drawer Nightstand, Extra Wide

29½" w x 19" d x 29¾" h SNMTG-02B4

Montgomery 2-Drawer Nightstand (Not Shown)

23½" w x 19" d x 29¾" h SNMTG-02B1

e Montgomery Nightstand Table, Extra Wide

29½" w x 19" d x 29¾" h SNMTG-01A4

Montgomery Nightstand Table (Not Shown)

23½" w x 19" d x 29¾" h SNMTG-01A1

NAOMI

SLEEP



S. Kaufman

SHOWN IN SOFT MAPLE, CHARCOAL



This style comes standard with Flat Black pulls (68-D-08).



Wood frame version available.

a



Features rolled slats.

b

a Naomi Panel Bed

Headboard: 55" h; Footboard: 14 3/8" h

CA King	82 3/4" w x 92 3/4" d	SBNAO-05B1
King	86 3/4" w x 88 3/4" d	SBNAO-05B2
Queen	70 3/4" w x 88 3/4" d	SBNAO-05B3
Full	64 3/4" w x 84 3/4" d	SBNAO-05B4
Twin	49 3/4" w x 84 3/4" d	SBNAO-05B5

b Naomi Platform Bed

Headboard: 46" h; Platform: 7 3/4" h

CA King	82 3/4" w x 90 3/4" d	SBNAO-05P1
King	86 3/4" w x 86 3/4" d	SBNAO-05P2
Queen	70 3/4" w x 86 3/4" d	SBNAO-05P3
Full	64 3/4" w x 82 3/4" d	SBNAO-05P4
Twin	49 3/4" w x 82 3/4" d	SBNAO-05P5

Not available with Under-Bed Storage.

Solid Foundation

No box springs required — the mattress sits on a rigid plywood foundation.

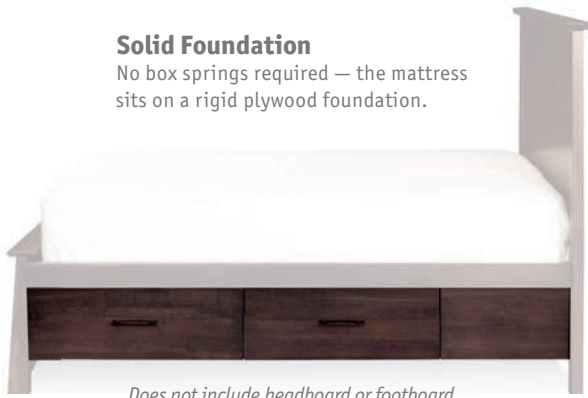

a

Does not include headboard or footboard.
Shown with two drawers each side configuration.



b



c



d



e



f



g



h

a Naomi Under-Bed Storage

Rail Top: 20"; Rail Bottom: 5½" from floor. Mattress Sits 2" Lower than Rail Top

CA King	SSNAO-13A-
King/Queen	SSNAO-13B-
Full	SSNAO-13C-
Twin	SSNAO-13D-

b Naomi 7-Drawer Dresser

63" w x 22½" d x 32¾" h SSNAO-08G2
73" w x 22½" d x 32¾" h SSNAO-08G3

Naomi Dresser Mirror

43" w x 36¾" h SMNAO-06A2
53" w x 36¾" h SMNAO-06A3

Features a beveled edge mirror.

c Naomi Mule Chest

59" w x 19½" d x 44¾" h SSNAO-11J0

Naomi Mule Chest Mirror

47" w x 29¾" h SMNAO-08A0

Features a beveled edge mirror.

d Naomi 12-Drawer Bureau

63" w x 22½" d x 47¾" h SSNAO-03M2
73" w x 22½" d x 47¾" h SSNAO-03M3

Naomi Bureau Mirror

56½" w x 26¾" h SMNAO-01A2
66½" w x 26¾" h SMNAO-01A3

Features a beveled edge mirror.

e Naomi 6-Drawer Chest

44" w x 22½" d x 48¼" h SSNAO-04F0

f Naomi Nightstand with Drawers

25½" w x 16½" d x 28½" h SNNAO-02C1

g Naomi Nightstand with Opening

25½" w x 16½" d x 28½" h SNNAO-04A1

h Naomi Platform Nightstand

25½" w x 16½" d x 18" h SNNAO-04A3

Features interior secret drawer.

Available with multiple drawer configurations.

PARKDALE

SLEEP



S. Kaufman

SHOWN IN SOFT MAPLE, MOCHA NUT



This style comes standard with Nickel Knob (70-B-25).



a



b

Includes entire bed.

a Parkdale 2-Panel Bed

Headboard: 56" h; Footboard: 20" h

CA King	77½" w x 87½" d	SBPAR-21B1
King	81½" w x 83½" d	SBPAR-21B2
Queen	65½" w x 83½" d	SBPAR-21B3
Full	59½" w x 79½" d	SBPAR-21B4
Twin	44½" w x 79½" d	SBPAR-21B5

b Parkdale 2-Panel Bed with Footboard Storage

Headboard: 56" h; Footboard: 20" h

CA King	77½" w x 87½" d	SBPAR-21F1
King	81½" w x 83½" d	SBPAR-21F2
Queen	65½" w x 83½" d	SBPAR-21F3
Full	59½" w x 79½" d	SBPAR-21F4
Twin	44½" w x 79½" d	SBPAR-21F5

Twin bed comes with only one drawer.

Solid Foundation

No box springs required — the mattress sits on a rigid plywood foundation.



a

Does not include headboard or footboard.



b



c



d



e



f



g



h

a Parkdale Under-Bed Storage

Rail Top: 18"; Rail Bottom: 5½" from floor
Mattress Sits 2" Lower than Rail Top

CA King SSPAR-18A4 2 Drawers Each Side
King/Queen SSPAR-18B4 2 Drawers Each Side
Full SSPAR-18C4 2 Drawers Each Side
Twin SSPAR-18D4 2 Drawers Each Side
Twin SSPAR-18D2 2 Drawers One Side

Sold separately from the bed.

b Parkdale 7-Drawer Chest

36" w x 18" d x 56½" h SSPAR-04F1

c Parkdale 6-Drawer Dresser

60" w x 18" d x 33½" h SSPAR-08F2
72" w x 18" d x 33½" h SSPAR-08F3

d Parkdale 8-Drawer Dresser

60" w x 18" d x 41" h SSPAR-08H0
72" w x 18" d x 41" h SSPAR-08H3

e Parkdale Nightstand with Open Cubby

22" w x 18" d x 28" h SNPAR-08B1

f Parkdale 2-Drawer Nightstand

26½" w x 18" d x 28" h SNPAR-02B1

g Parkdale 3-Drawer Nightstand

22" w x 18" d x 28" h SNPAR-02C1

h Parkdale 3-Drawer Nightstand, Extra Wide

30" w x 18" d x 28" h SNPAR-08C4

PRAIRIE MISSION

SLEEP



S. Kauffman

SHOWN IN OAK, CHESTNUT



This style comes standard with Black Hammered Brass Pulls (60-G-02 on doors) (60-G-03 on drawers)



Wood frame version available.

a



Wood frame version available.

b

a Prairie Mission Paneled Slat Bed

Headboard: 50"h; Footboard: 30¾"h	
CA King 84½"w x 92"d	SBPMS-05B1
King 88½"w x 88"d	SBPMS-05B2
Queen 72½"w x 88"d	SBPMS-05B3
Full 66½"w x 84"d	SBPMS-05B4
Twin 51½"w x 84"d	SBPMS-05B5

b Prairie Mission Slat Bed

Headboard: 50"h; Footboard: 36"h	
CA King 84½"w x 92"d	SBPMS-10B1
King 88½"w x 88"d	SBPMS-10B2
Queen 72½"w x 88"d	SBPMS-10B3
Full 66½"w x 84"d	SBPMS-10B4
Twin 51½"w x 84"d	SBPMS-10B5



a



b



c

a Prairie Mission Under-Bed Storage

Rail Top: 20"; Rail Bottom: 5½"
 Mattress Sits 2" Lower than Rail Top
 CA King SSPRM-13A
 King/Queen SSPRM-13B
 Full SSPRM-13C
 Twin SSPRM-13D

Sold separately from the bed.

b Prairie Mission 12-Drawer Bureau

61½" w x 22¾" d x 46¼" h EC17012B
 71½" w x 22¾" d x 46¼" h EC24512B

Prairie Mission Bureau Mirror

58¾" w x 27¾" h MESBMPM
 68¾" w x 27¾" h MELBMPM

Features a beveled edge mirror.

c Prairie Mission 7-Drawer Dresser

61½" w x 22¾" d x 33¼" h EC1607D
 71½" w x 22¾" d x 33¼" h EC22070-7

Prairie Mission Dresser Mirror

45¼" w x 43" h ME330DCPM
 55¼" w x 43" h ME330-LPM

Features a beveled edge mirror.

Available with multiple drawer configurations.



a



b



c



d



e

a Prairie Mission Tall Armoire on Chest
41½" w x 22¾" d x 77½" h EC205-1AC

Features three adjustable shelves
and a clothes rod.

b Prairie Mission 9-Drawer Chest
41½" w x 22¾" d x 57¼" h EC1759DC

c Prairie Mission 6-Drawer Chest
41½" w x 22¾" d x 48¾" h EC1806DC

d Prairie Mission Lingerie Chest
24" w x 19¾" d x 48¾" h EC105LC

e Prairie Mission Blanket Chest with False Fronts
41½" w x 20¼" d x 19¾" h EC155BC-

 Available with fabric cushion seat or leather cushion seat. If using your own fabric please supply 2 yards. COM=Grade 3.



a



b



c



d

a Prairie Mission Nightstand Table with Drawer
24" w x 18" d x 28" h EC20BT

b Prairie Mission Nightstand with Doors
24" w x 17½" d x 24¾" h EC115NS
Features a pullout surface under the top.

Prairie Mission Deluxe Nightstand with Doors (Not Shown)
28" w x 20¼" d x 30¾" h EC150SNS
Features a pullout surface under the top and one adjustable shelf behind the doors (Deluxe version only).

c Prairie Mission Nightstand with Drawers
24" w x 17½" d x 24¾" h EC120BC
Features a pullout surface under the top.

Prairie Mission Deluxe Nightstand with Drawers (Not Shown)
28" w x 20¼" d x 30¾" h EC140SBC
Features a pullout surface under the top.

d Prairie Mission Nightstand with Opening
24" w x 17½" d x 24¾" h EC110NS
Prairie Mission Deluxe Nightstand with Opening (Not Shown)
28" w x 20¼" d x 30¾" h EC145SNS

ROYAL MISSION

SLEEP



S. Kauffman

SHOWN IN QUARTERSAWN, CHESTNUT

This style comes standard with Walnut Knobs (WK-A-03)



Wood frame version available.

a



b

a Royal Mission Panel Bed with Walnut Inlay

Headboard: 50" h; Footboard: 33" h

CA King	82½" w x 90½" d	SBRMS-05B1
King	86½" w x 86½" d	SBRMS-05B2
Queen	71½" w x 86½" d	SBRMS-05B3
Full	64" w x 82½" d	SBRMS-05B4
Twin	49" w x 82½" d	SBRMS-05B5

b Royal Mission 6-Drawer Chest with Walnut Inlay

40" w x 21½" d x 51" h

ME215CD



a



b



c



d



e



f



g

a Royal Mission 12-Drawer Bureau with Walnut Inlay

60" w x 21½" d x 49" h ME243-60B
70" w x 21½" d x 49" h ME243-70B

Royal Mission Bureau Mirror with Walnut Inlay

56" w x 33½" h MESBMRM
66" w x 33½" h MELBMRM

Features a beveled edge mirror.

b Royal Mission Mule Chest with Walnut Inlay

54" w x 18½" d x 44½" h ME214MC

Royal Mission Mule Chest Mirror with Walnut Inlay

46" w x 33¼" h MEMCM-RM

Features a beveled edge mirror.

c Royal Mission 7-Drawer Dresser with Walnut Inlay

60" w x 21½" d x 34" h ME2216D
70" w x 21½" d x 34" h ME2216-70D

Royal Mission Tri-View Mirror with Walnut Inlay (Shown)

52" w x 44" h ME317TVRM
62" w x 44" h ME3130TVRM

Features a beveled edge mirror.

Royal Mission Dresser Mirror with Walnut Inlay (Inset)

42" w x 44" h ME330DCRM
52" w x 44" h ME330-LRM

Features a beveled edge mirror.

d Royal Mission Blanket Chest with False Fronts and Walnut Inlay

40" w x 20" d x 20½" h ME237BC

e Royal Mission Nightstand Table with Walnut Inlay

24" w x 19" d x 28" h ME220BT

f Royal Mission Nightstand with Drawers and Walnut Inlay

23" w x 15½" d x 28¾" h ME219BC

g Royal Mission Deluxe Nightstand with Drawers and Walnut Inlay

27" w x 18½" d x 33" h ME2219SBC

Features a pullout surface under the top.

Available with wood seat, fabric cushion seat, or leather cushion seat. If using your own fabric please supply 2 yards. COM=Grade 3.

SAN MIGUEL

SLEEP



M. Miller

SHOWN IN CHARACTER QUARTERSAWN WHITE OAK, MICHAEL'S



This style comes standard with Black Mission pulls (61-A-03).

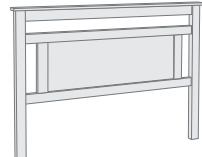

Horizon Open-Panel Headboard Option
SAOBED-OPEN

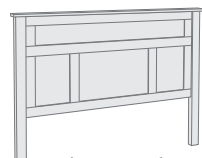

Horizon 4-Panel Headboard Option
SAOBED-4PANEL

a San Miguel Panel Headboard with Wood Frame

Headboard: 48" h; Footboard: 13½" h

CA King	82½" w x 88" d	SBMIG-05W1
King	86½" w x 84" d	SBMIG-05W2
Queen	70½" w x 84" d	SBMIG-05W3
Full	64½" w x 80" d	SBMIG-05W4
Twin	49½" w x 80" d	SBMIG-05W5

b San Miguel Panel Bed with Footboard Storage

Headboard: 48" h; Footboard: 18½" h

CA King	82½" w x 88" d	SBMIG-05F1
King	86½" w x 84" d	SBMIG-05F2
Queen	70½" w x 84" d	SBMIG-05F3
Full	64½" w x 80" d	SBMIG-05F4
Twin	49½" w x 80" d	SBMIG-05F5

Twin bed comes with only one drawer.

Solid Foundation

No box springs required — the mattress sits on a rigid plywood foundation.

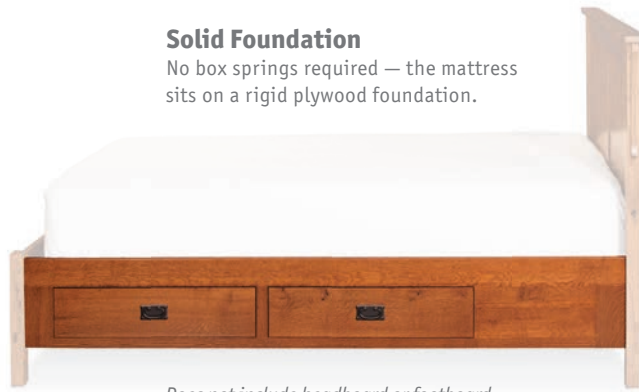

a

Does not include headboard or footboard.



b



c



d



e



f

a San Miguel Under-Bed Storage

Rail Top: 20½"; Rail Bottom: 5¾" from floor.
Mattress Sits 2" lower than Rail Top

- CA King SSMIG-18A-☞
- King/Queen SSMIG-18B-☞
- Full SSMIG-18C-☞
- Twin SSMIG-18D-☞

Sold separately from the bed.

b San Miguel Mule Chest ☞☞

54" w x 18¾" d x 44¾" h SSMIG-11J0

San Miguel Mule Chest Mirror ☞☞

46½" w x 31" h SMMIG-08A0

Features a beveled edge mirror.

c San Miguel 7-Drawer Dresser ☞☞☞

58" w x 18½" d x 36" h SSMIG-08G1

San Miguel Dresser Mirror ☞☞☞

42½" w x 37½" h SMMIG-06A2

Features a beveled edge mirror.

d San Miguel 6-Drawer Chest ☞☞☞

36" w x 18½" d x 52" h SSMIG-04F0

e San Miguel Nightstand with Opening on Bottom ☞☞☞

22" w x 18½" d x 27½" h SNMIG-04A1

f San Miguel Nightstand with Drawers ☞☞☞

22" w x 18½" d x 27½" h SNMIG-02C1

☞ Available with multiple drawer configurations.

SAVANNAH

SLEEP



This style comes standard with Wood Knobs (WK-A-01).

SHOWN IN SOFT MAPLE, MICHAEL'S



a



b

a Savannah Sleigh Bed

Headboard: 56" h; Footboard: 27½" h

CA King	78" w x 94" d	SBSAV-09B1
King	82" w x 90" d	SBSAV-09B2
Queen	66" w x 90" d	SBSAV-09B3
Full	60" w x 86" d	SBSAV-09B4
Twin	46" w x 86" d	SBSAV-09B5

Not available with under-bed storage.

b Savannah Poster Bed

Headboard: 61½" h (posts 80" h)

Footboard: 34¾" h (posts 80" h)

CA King	78" w x 92" d	SBSAV-02B1
King	82" w x 88" d	SBSAV-02B2
Queen	66" w x 88" d	SBSAV-02B3
Full	60" w x 84" d	SBSAV-02B4
Twin	45" w x 84" d	SBSAV-02B5



a *Wood frame version available.*



b *Wood frame version available.*

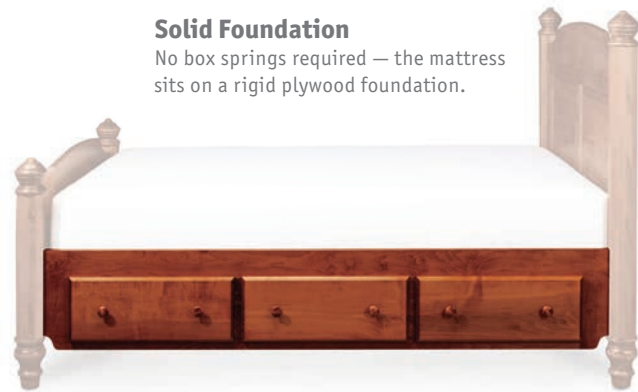

Solid Foundation

No box springs required — the mattress sits on a rigid plywood foundation.

c *Does not include headboard or footboard.*



d

a Savannah Panel Bed

Headboard: 61½" h (posts 55¼" h)
 Footboard: 34¾" h (posts 33¼" h)
 CA King 78" w x 92" d SBSAV-05B1
 King 82" w x 88" d SBSAV-05B2
 Queen 66" w x 88" d SBSAV-05B3
 Full 60" w x 84" d SBSAV-05B4
 Twin 45" w x 84" d SBSAV-05B5

Available with multiple drawer configurations.

b Georgia Panel Bed

Headboard: 54" h; Footboard: 33¼" h
 CA King 78" w x 92" d SBGEO-05B1
 King 82" w x 88" d SBGEO-05B2
 Queen 66" w x 88" d SBGEO-05B3
 Full 60" w x 84" d SBGEO-05B4
 Twin 46" w x 84" d SBGEO-05B5

c Georgia Under-Bed Storage

Rail Top: 20"; Rail Bottom: 5½"
 Mattress Sits 2" Lower than Rail Top
 CA King SSGRG-13A
 King/Queen SSGRG-13B
 Full SSGRG-13C
 Twin SSGRG-13D

Sold separately from the bed.

d Savannah Mule Chest

54" w x 19½" d x 44½" h MES314MC

Savannah Mule Chest Mirror

45" w x 30¾" h MEMCM-SV

Features a beveled edge mirror.

Savannah Deluxe Bureau Mirror



a



b



c



d



e

- a Savannah 12-Drawer Bureau**
 60" w x 22½" d x 48" h MES43-60B
 70" w x 22½" d x 48" h MES43-70B

Savannah Bureau Mirror (Shown)
 55" w x 28" h MESBMB
 65" w x 28" h MESLBM

Features a beveled edge mirror.

Savannah Deluxe Bureau Mirror (Inset)
 54" w x 33" h MESDBMS
 64" w x 33" h MESDBML
 Features a beveled edge mirror.

- b Savannah 7-Drawer Dresser**
 60" w x 22½" d x 34" h MES716D-60
 70" w x 22½" d x 34" h MES716D-70

Savannah Dresser Mirror
 41" w x 37½" h MES30-M
 51" w x 37½" h MES30-L

Features a beveled edge mirror.

- c Savannah 3-Drawer Wardrobe**
 42½" w x 22½" d x 71½" h MES38WR3

Features three adjustable shelves and a clothes rod.

- d Savannah Chest Armoire**
 40" w x 22½" d x 71½" h MES115CA

Door Areas: 16" w x 20" d x 53" h

Features an adjustable shelf.

- e Savannah 9-Drawer Chest**
 40" w x 22½" d x 56" h MES915CD



a



b



c



d



e



f



g



h



i

a Savannah 6-Drawer Chest

40" w x 22½" d x 49½" h MES15CD

b Savannah Lingerie Chest

23" w x 19½" d x 49½" h MES29LC

c Savannah Blanket Chest with False Fronts

40" w x 21" d x 21½" h MES37BC

d Savannah Nightstand with Doors

23" w x 16½" d x 28" h MES18NS

Features open space behind doors.

e Savannah Deluxe Nightstand with Doors

27" w x 19½" d x 34" h MES18SNS

Features a pullout surface under the top and one adjustable shelf behind the doors.

f Savannah Nightstand with Opening

23" w x 16½" d x 28" h MES05NS

g Savannah Nightstand with Drawers

23" w x 16½" d x 28" h MES19BC

h Savannah Deluxe Nightstand with Drawers

27" w x 19½" d x 34" h MES19SBC

Features a pullout surface under the top.

i Savannah Nightstand with Drawers, Extra Wide

32" w x 18" d x 32" h SNSAV-02C4

Available with wood seat, fabric cushion seat, or leather cushion seat. If using your own fabric please supply 2 yards. COM=Grade 3.

SHAKER

SLEEP



M. Miller

SHOWN IN CHERRY, AUTUMN HAZE



This style comes standard with Wood Knobs (WK-A-01).



a



b

Shown with optional Canopy Top.

a Shaker Panel Bed

Headboard: 55" h; Footboard: 25" h

CA King	78½" w x 92" d	SBSHK-05B1
King	82½" w x 88" d	SBSHK-05B2
Queen	66½" w x 88" d	SBSHK-05B3
Full	60½" w x 84" d	SBSHK-05B4
Twin	45½" w x 84" d	SBSHK-05B5

b Shaker Pencil Post Bed

Headboard: 46¾" h; Posts: 81½" h

CA King	77" w x 90" d	SBSHK-07B1
King	81" w x 86" d	SBSHK-07B2
Queen	65" w x 86" d	SBSHK-07B3
Full	59" w x 82" d	SBSHK-07B4
Twin	44" w x 82" d	SBSHK-07B5

NO FOOTBOARD REQUIRED?

A wood frame version is available on most bed versions. The headboard remains the same, but the footboard is replaced with a wood frame.



Solid Foundation

No box springs required — the mattress sits on a rigid plywood foundation.

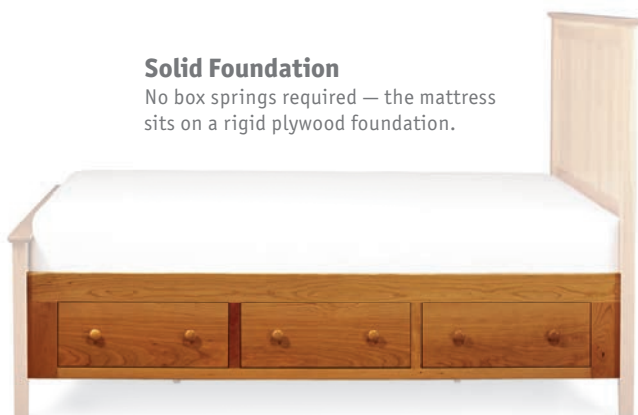

a

Does not include headboard or footboard.



b



c



d

a Shaker Under-Bed Storage

Rail Top: 20"; Rail Bottom: 5½"
 Mattress Sits 2" Lower than Rail Top
 CA King SSSHK-13A
 King/Queen SSSHK-13B
 Full SSSHK-13C
 Twin SSSHK-13D

Sold separately from the bed.

Available with multiple drawer configurations.

b Shaker 12-Drawer Bureau

58" w x 21¼" d x 47¾" h ME843-60B
 69½" w x 21¼" d x 47¾" h ME843-70B

Shaker Bureau Mirror

52" w x 27¾" h MESBMS
 62" w x 27¾" h MELBMS

Features a beveled edge mirror.

c Shaker 6-Drawer Dresser

58" w x 21¼" d x 33" h ME816D
 69½" w x 21¼" d x 33" h ME816-68D

Shaker Dresser Mirror

27½" w x 41½" h ME317CS
 38½" w x 41½" h ME330DCS
 48½" w x 41½" h ME330-LS

Features a beveled edge mirror.

d Shaker Mule Chest

54" w x 18¾" d x 44½" h ME814MC

Shaker Mule Chest Mirror

42½" w x 1½" d x 30½" h MEMCM-SH
 Features a beveled edge mirror.



a



b



c



d



e

a Shaker 7-Drawer Dresser

58" w x 21 1/4" d x 33 1/4" h ME8816D
 69 1/2" w x 21 1/4" d x 33 1/4" h ME8816-68D

Shaker Tri-View Mirror

50 1/4" w x 41 1/2" h ME317TVS
 63 1/4" w x 41 1/2" h ME3130TVS

Features a beveled edge mirror.

b Shaker Wardrobe

41" w x 21 1/4" d x 72 1/4" h ME832WR

Features four adjustable shelves and three clothes rods.

c Shaker Armoire on Chest

39" w x 21 1/4" d x 77" h ME8822

Features three adjustable shelves and a clothes rod.

d Shaker 5-Drawer Chest

39" w x 21 1/4" d x 48 1/2" h ME807CD

e Shaker 6-Drawer Chest

39" w x 21 1/4" d x 48 1/2" h ME815CD



a



b



c



d



e

a Shaker Blanket Chest with False Fronts
39½" w x 19½" d x 19¼" h ME837BC-🍃

b Shaker Lingerie Chest
22½" w x 18¼" d x 47¼" h ME829LC

c Shaker Nightstand with Drawers
22½" w x 15¼" d x 25¼" h ME819BC

Shaker Deluxe Nightstand with Drawers
(Not Shown)
26½" w x 18¼" d x 31¼" h ME8819SBC

Features a pullout surface under the top.

d Shaker Nightstand with Opening
22½" w x 15¼" d x 25¼" h ME805NS

e Shaker Nightstand Table
24" w x 18" d x 29" h TVSHNS

🍃 Available with fabric cushion seat or leather cushion seat. If using your own fabric please supply 2 yards. COM=Grade 3.

SHEFFIELD

SLEEP



SHOWN IN CHARACTER CHERRY, HAZELNUT; WIRE BRUSHED



This style comes standard with Brushed Pewter Pulls (82-B-01).



a



b

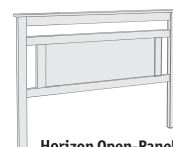

Horizon Open-Panel Headboard Option
SAOBED-OPEN

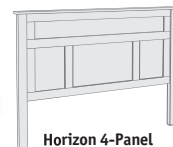

Horizon 4-Panel Headboard Option
SAOBED-4PANEL

a Sheffield Headboard with Wood Frame

Headboard: 47 $\frac{3}{4}$ "h

CA King	77 $\frac{1}{4}$ "w x 87 $\frac{3}{4}$ "d	SBSHE-05W1
King	81 $\frac{1}{4}$ "w x 83 $\frac{3}{4}$ "d	SBSHE-05W2
Queen	65 $\frac{1}{4}$ "w x 83 $\frac{3}{4}$ "d	SBSHE-05W3
Full	59 $\frac{1}{4}$ "w x 79 $\frac{3}{4}$ "d	SBSHE-05W4
Twin	44 $\frac{1}{4}$ "w x 79 $\frac{3}{4}$ "d	SBSHE-05W5

b Sheffield Bed with Footboard Storage

Headboard: 47 $\frac{3}{4}$ "h

CA King	77 $\frac{1}{4}$ "w x 87 $\frac{3}{4}$ "d	SBSHE-05F1
King	81 $\frac{1}{4}$ "w x 83 $\frac{3}{4}$ "d	SBSHE-05F2
Queen	65 $\frac{1}{4}$ "w x 83 $\frac{3}{4}$ "d	SBSHE-05F3
Full	59 $\frac{1}{4}$ "w x 79 $\frac{3}{4}$ "d	SBSHE-05F4
Twin	44 $\frac{1}{4}$ "w x 79 $\frac{3}{4}$ "d	SBSHE-05F5

Twin bed comes with only one drawer.

Solid Foundation

No box springs required — the mattress sits on a rigid plywood foundation.

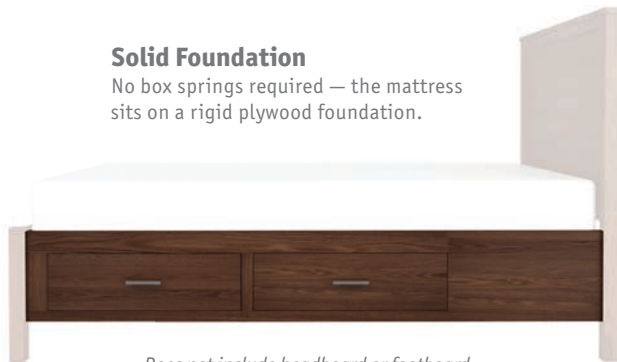

Does not include headboard or footboard.

a



b



d



c



e



f

a Sheffield Under-Bed Storage

Rail Top: 20"; Rail Bottom: 5½" from floor

Mattress Sits 2" Lower than Rail Top

CA King SSSHE-18A

King/Queen SSSHE-18B

Full SSSHE-18C

Twin SSSHE-18D

Sold separately from the bed.

b Sheffield 8-Drawer Mule Chest

58" w x 18" d x 46" h SSSHE-11H2

Sheffield Mule Chest Mirror

39¾" w x 27¾" h SMSHE-08A0

Features a beveled edge mirror.

c Sheffield 5-Drawer Chest

36" w x 18" d x 53¼" h SSSHE-04E0

d Sheffield 6-Drawer Dresser

58" w x 18" d x 36" h SSSHE-08F2

Sheffield Dresser Mirror

35¾" w x 34¾" h SMSHE-10A2

Features a beveled edge mirror.

e Sheffield Nightstand with Drawers

22" w x 18" d x 28½" h SNSHE-02C1

f Sheffield Nightstand with Opening on Bottom

22" w x 18" d x 28½" h SNSHE-04A1

SHENANDOAH

SLEEP



This style comes standard with Black Knobs (WK-A-05).

SHOWN IN CHARACTER CHERRY, MICHAEL'S



a



b

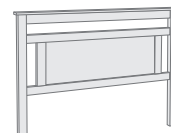

Horizon Open-Panel Headboard Option
SAOBED-OPEN
Not available on Deluxe Headboard.

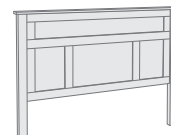

Horizon 4-Panel Headboard Option
SAOBED-4PANEL
Not available on Deluxe Headboard.

a Shenandoah Bed

Headboard: 48" h; Footboard: 24" h

CA King	78" w x 88 1/4" d	SBSHS-05B1
King	82" w x 84 1/4" d	SBSHS-05B2
Queen	66" w x 84 1/4" d	SBSHS-05B3
Full	60" w x 80 1/4" d	SBSHS-05B4
Twin	45" w x 80 1/4" d	SBSHS-05B5

b Shenandoah Headboard with Wood Frame

Headboard: 48" h; Footboard: 13 1/2" h

CA King	78" w x 87 1/2" d	SBSHS-05W1
King	82" w x 83 1/2" d	SBSHS-05W2
Queen	66" w x 83 1/2" d	SBSHS-05W3
Full	60" w x 79 1/2" d	SBSHS-05W4
Twin	45" w x 79 1/2" d	SBSHS-05W5



a



b



c



Solid Foundation

No box springs required — the mattress sits on a rigid plywood foundation.

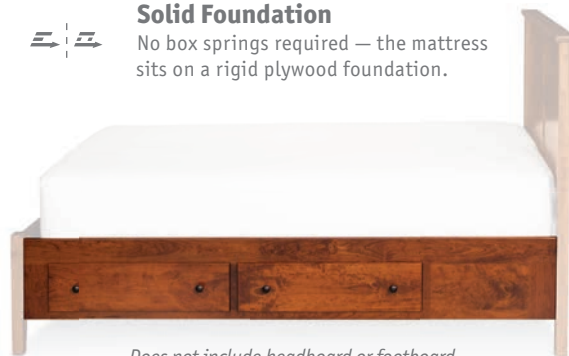

Does not include headboard or footboard.

d

a Shenandoah Deluxe Headboard with Wood Frame

Headboard: 58 $\frac{1}{4}$ "h; Footboard: 13 $\frac{1}{2}$ "h
 CA King 81"w x 87 $\frac{1}{2}$ "d SBSHD-05W1
 King 85"w x 83 $\frac{1}{2}$ "d SBSHD-05W2
 Queen 69"w x 83 $\frac{1}{2}$ "d SBSHD-05W3
 Full 63"w x 79 $\frac{1}{2}$ "d SBSHD-05W4
 Twin 48"w x 79 $\frac{1}{2}$ "d SBSHD-05W5

b Shenandoah Bed with Footboard Storage

Headboard: 48"h; Footboard: 18 $\frac{1}{2}$ "h
 CA King 78"w x 87 $\frac{1}{2}$ "d SBSHS-05F1
 King 82"w x 83 $\frac{1}{2}$ "d SBSHS-05F2
 Queen 66"w x 83 $\frac{1}{2}$ "d SBSHS-05F3
 Full 60"w x 79 $\frac{1}{2}$ "d SBSHS-05F4
 Twin 45"w x 79 $\frac{1}{2}$ "d SBSHS-05F5
 Twin bed comes with only one drawer.

c Shenandoah Deluxe Bed with Footboard Storage

Headboard: 58 $\frac{1}{4}$ "h; Footboard: 18 $\frac{1}{2}$ "h
 CA King 81"w x 87 $\frac{1}{2}$ "d SBSHD-05F1
 King 85"w x 83 $\frac{1}{2}$ "d SBSHD-05F2
 Queen 69"w x 83 $\frac{1}{2}$ "d SBSHD-05F3
 Full 63"w x 79 $\frac{1}{2}$ "d SBSHD-05F4
 Twin 48"w x 79 $\frac{1}{2}$ "d SBSHD-05F5
 Twin bed comes with only one drawer.

d Shenandoah Under-Bed Storage

Rail Top: 20"; Rail Bottom: 5 $\frac{1}{2}$ " from floor
 Mattress Sits 2" Lower than Rail Top
 CA King SSSHS-18A
 King/Queen SSSHS-18B
 Full SSSHS-18C
 Twin SSSHS-18D
 Sold separately from the bed.

Available with multiple drawer configurations.



EXPRESS



QUICKSHIP

simplyamish



a



b



c

a Shenandoah 12-Drawer Bureau

58" w x 18 1/4" d x 46 3/4" h SSSHS-03M2
 68" w x 18 1/4" d x 46 3/4" h SSSHS-03M3

Shenandoah Bureau Mirror

52" w x 31 1/2" h SMSHS-01A2
 62" w x 31 1/2" h SMSHS-01A3

Features a beveled edge mirror.

b Shenandoah 7-Drawer Dresser

58" w x 18" d x 36" h SSSHS-08G2

Shenandoah Dresser Mirror

38 1/2" w x 41 1/2" h SMSHS-10A2

Features a beveled edge mirror.

c Shenandoah Mule Chest

54" w x 18" d x 44 1/2" h SSSHS-11J0

Shenandoah Mule Chest Mirror

42" w x 34 1/2" h SMSHS-08A0

Features a beveled edge mirror.



a





b



c



d

a Shenandoah 6-Drawer Chest  
36" w x 18" d x 52" h SSSHS-04F0

b Shenandoah Lingerie Chest  
23" w x 18" d x 52" h SSSHS-15E0

c Shenandoah Nightstand with Opening on Bottom  
22" w x 18" d x 27½" h SNSHS-04A1

d Shenandoah Nightstand with Drawers  
22" w x 18" d x 27½" h SNSHS-02C1

SHERIDAN

SLEEP



SHOWN IN CHERRY/WALNUT, AMBER GLOW



This style comes standard with Black Pull (68-C-15).



a



Features black metal accents.

a Sheridan Bed

Headboard: 68"h; Footboard: 30"h

CA King 77"w x 93"d	SBSHR-05B1
King 81"w x 89"d	SBSHR-05B2
Queen 65"w x 89"d	SBSHR-05B3
Full 59"w x 85"d	SBSHR-05B4
Twin 44"w x 85"d	SBSHR-05B5

Walnut Accents Standard



a



b



Finger pulls on top drawers.



c



d

a Sheridan Mule Chest

54½" w x 20½" d x 44" h SSSHR-11J0
Walnut Accents Standard.

Sheridan Mule Chest Mirror

45½" w x 33" h SMSHR-08A0

Sheridan 6-Drawer Chest (Not Shown)

38" w x 23¼" d x 52" h SSSHR-04F0
Walnut Accents Standard.

b Sheridan 7-Drawer Dresser

62" w x 23¼" d x 36" h SSSHR-08G2
72" w x 23¼" d x 36" h SSSHR-08G3
Walnut Accents Standard.

Sheridan Dresser Mirror

(for 62" w) 41½" w x 40" h SMSHR-06G2
(for 72" w) 51½" w x 40" h SMSHR-06G3

c Sheridan Nightstand with Drawers

27" w x 20¼" x 25" SNSHR-02C1
Walnut Accents Standard

Sheridan Nightstand with Opening (Not Shown)

27" w x 20¼" x 25" SNSHR-04A1
Walnut Accents Standard

d Sheridan Nightstand with Drawers, Extra Wide

32" w x 20¼" x 32½" SNSHR-02C4
Walnut Accents Standard

SOPHIA

SLEEP



SHOWN IN SOFT MAPLE, AVALON



This style comes standard with Nickel Knobs (70-E-11).



a



b

a Sophia Bed

Headboard 56½" h; Footboard 33" h

CA King	82½" w x 96" d	SBSF1-05B1
King	86½" w x 92" d	SBSF1-05B2
Queen	70½" w x 92" d	SBSF1-05B3
Full	64½" w x 88" d	SBSF1-05B4
Twin	49½" w x 88" d	SBSF1-05B5

Not available with Under-Bed Storage

b Sophia Panel Bed

Headboard 56½" h; Footboard 33" h

CA King	82½" w x 96" d	SBSF2-05B1
King	86½" w x 92" d	SBSF2-05B2
Queen	70½" w x 92" d	SBSF2-05B3
Full	64½" w x 88" d	SBSF2-05B4
Twin	49½" w x 88" d	SBSF2-05B5

Not available with Under-Bed Storage



a



b



c



d



e

a Sophia 12-Drawer Bureau

60½" w x 23" d x 48" h MESO43-60B
70½" w x 23" d x 48" h MESO43-70B

Sophia Bureau Mirror

57" w x 27" h MESOSBM
67" w x 27" h MESOLBM

Features a beveled edge mirror.

b Sophia Mule Chest

53½" w x 20" d x 44¾" h MESO314MC

Sophia Mule Chest Mirror

47" w x 30" h MEMCM-SO

Features a beveled edge mirror.

c Sophia 6-Drawer Chest

41½" w x 23" d x 50½" h MESO15CD

d Sophia Lingerie Chest

24½" w x 20" d x 50½" h MESO29LC

e Sophia Nightstand with Drawers

23" w x 17" d x 29¾" h MESO19BC

Sophia Deluxe Nightstand with Drawers (Not Shown)

25¾" w x 20" d x 33¾" h MESO19SBC

Features a pullout surface under the top.

WILDWOOD

SLEEP



This style comes standard with Brushed Antique Copper Pull (92-F-11).

SHOWN IN CHARACTER CHERRY, AUTUMN HAZE



a



b

Includes entire bed.

a Wildwood Bed

Headboard: 48½" h

CA King	76" w x 88½" d	SBWIL-23B1
King	80" w x 84½" d	SBWIL-23B2
Queen	64" w x 84½" d	SBWIL-23B3
Full	58" w x 80½" d	SBWIL-23B4
Twin	53" w x 80½" d	SBWIL-23B5

Features Rolled Slats.

b Wildwood Bed with Footboard Storage

Headboard: 48½" h

CA King	76" w x 88½" d	SBWIL-23F1
King	80" w x 84½" d	SBWIL-23F2
Queen	64" w x 84½" d	SBWIL-23F3
Full	58" w x 80½" d	SBWIL-23F4
Twin	53" w x 80½" d	SBWIL-23F5

Twin bed comes with only one drawer.
Features Rolled Slats.



a



b



d



e



f



g



c

a Wildwood Canopy Bed

Headboard: 48½”h; Posts: 90”h

CA King	77”w x 88½”d	SBWIL-24B1
King	81”w x 84½”d	SBWIL-24B2
Queen	65”w x 84½”d	SBWIL-24B3
Full	59”w x 80½”d	SBWIL-24B4
Twin	54”w x 80½”d	SBWIL-24B5

King and California King will ship disassembled.
Features Rolled Slats.

b Wildwood 8-Drawer Dresser

60”w x 18”d x 38”h	SSWIL-08H2
72”w x 18”d x 38”h	SSWIL-08H3

c Wildwood 7-Drawer Chest

36”w x 18”d x 58¼”h	SSWIL-04G0
---------------------	------------

d Wildwood 5-Drawer Chest

36”w x 18”d x 46¼”h	SSWIL-04E0
---------------------	------------

e Wildwood 3-Drawer Nightstand

22”w x 18”d x 24½”h	SNWIL-02C1
---------------------	------------

f Wildwood 3-Drawer Nightstand, Extra Wide

30”w x 18”d x 24½”h	SNWIL-02C4
---------------------	------------

g Wildwood Nightstand with Open Cubby, Extra Wide

30”w x 18”d x 24½”h	SNWIL-08B4
---------------------	------------

BEDS

SLEEP



Look for these icons in this section's product descriptions.



Available as EXPRESS
Available as QUICKSHIP

COLBURN BEDROOM SHOWN IN SOFT MAPLE, BOURBON

Pillars and platforms and posts. Oh my. Rest assured, we offer plenty of variety when it comes to beds. From sleigh beds to platforms to traditional four-poster designs, we offer countless styles, all built to the same exceptional standard.



STANDARD BED HARDWARE

Our wooden bed frames connect with non-glued dowels and a heavy steel bolt anchored by an engineered nut. We supply a wrench for tightening the bolts should they loosen.

Angle Iron runs the length of the rails to strengthen the rail and support the slats.



STANDARD SLATS

Each of our beds come with five wooden slats to support your mattress foundation. On queen beds three of the slats will have additional support feet. On king and california king beds all 5 slats have additional support feet. These slats are supported on the side rails by the angle iron.

Slats only. Does not include bed frame.

ROLLED SLATS – OPTION

Looking to lower the height of your mattress? Order our Rolled Slats option and you will receive everything you need to put your mattress directly onto any of our beds, eliminating the need for traditional box springs. When selecting this option, you may consider altering the height of your headboard, depending on the style.

Side rails on standard Simply Amish beds have an 8" clearance. With slats installed, your foundation will be just 9" off the floor. 2" gaps between the wooden slats.

KAORS-99 *Slats only. Does not include bed frame.*



UNDER-BED STORAGE – OPTION

Due to the popular nature of under-bed storage, we have carefully designed ours so it can be added to almost any of our beds. Please check specific beds for information on which beds can accept our Under-Bed Storage.

Under-Bed Storage is sold separately from the headboard and footboard. The desired bed must be purchased as well. If Under-Bed Storage is ordered to be used on a headboard with wood frame, the footboard height is increased to accommodate the drawer units.



WOOD FRAME – OPTION

No Footboard, No Problem. For those of you who like to hang your feet off the bed we have a solution for you. Most of our beds can be ordered with a wood frame which will eliminate the footboard giving you ample room to stretch out.



COMPLETE WOOD FRAME BED – OPTION

Not looking for a headboard or footboard, but want a sturdy bed that will last a lifetime? Look no further...

Headboard: 14"h; Footboard: 14"h

CA King	76½"w x 90"d	SBWFR-15W1
King	80½"w x 86"d	SBWFR-15W2
Queen	64½"w x 86"d	SBWFR-15W3
Full	58½"w x 82"d	SBWFR-15W4
Twin	43½"w x 82"d	SBWFR-15W5



HEADBOARD ONLY – OPTION

When a headboard is all you want, it's all you'll need to order. Just select the style of your choice and order the Headboard only. There are also options available to customize the height.

This will require the purchase and installation of mounting brackets to attach an existing frame. **There are no pre-drilled holes**, allowing you to use the hardware of your choice.

Optional Adapter Plate - JMAP61



UPHOLSTERED HEADBOARD – OPTION

By adding fabric or leather to select headboards, create a dramatic custom headboard.





a



b



c



d



e



f

Includes entire bed.

a Aspen Bookcase Bed with Inlay

Headboard: 54½" h; Footboard: 13¼" h

CA King	77½" w x 94¾" d	SBASP-01W1
King	81½" w x 90¾" d	SBASP-01W2
Queen	65½" w x 90¾" d	SBASP-01W3
Full	59½" w x 86¾" d	SBASP-01W4
Twin	44½" w x 86¾" d	SBASP-01W5

b Bookcase Bed

Headboard: 9½" d x 44½" h; Footboard: 14" h

CA King	78½" w x 97" d	SBBKB-01B1
King	82½" w x 93" d	SBBKB-01B2
Queen	66½" w x 93" d	SBBKB-01B3
Full	60½" w x 89" d	SBBKB-01B4
Twin	45½" w x 89" d	SBBKB-01B5

c Justine Bookcase Bed

Headboard: 9½" d x 54" h; Footboard: 13½" h

CA King	76" w x 96" d	SBJUS-01W1
King	80" w x 92" d	SBJUS-01W2
Queen	64" w x 92" d	SBJUS-01W3
Full	58" w x 88" d	SBJUS-01W4
Twin	43" w x 88" d	SBJUS-01W5

d MäRyan Bookcase Bed

Headboard: 12¾" d x 54" h; Footboard: 14" h

CA King	83" w x 97" d	SBMRY-01B1
King	87" w x 93" d	SBMRY-01B2
Queen	71" w x 93" d	SBMRY-01B3
Full	65" w x 89" d	SBMRY-01B4
Twin	50" w x 89" d	SBMRY-01B5

e Aspen Panel Bed with Inlay

Headboard: 50" h; Footboard: 31" h

CA King	78½" w x 93" d	SBASP-05B1
King	82" w x 89" d	SBASP-05B2
Queen	66" w x 89" d	SBASP-05B3
Full	60½" w x 85" d	SBASP-05B4
Twin	45½" w x 85" d	SBASP-05B5

f Aspen Panel Bed with Footboard Storage

Headboard: 50" h; Footboard: 18½" h

CA King	78½" w x 89½" d	SBASP-05F1
King	82½" w x 85½" d	SBASP-05F2
Queen	66½" w x 85½" d	SBASP-05F3
Full	60½" w x 81½" d	SBASP-05F4
Twin	45½" w x 81½" d	SBASP-05F5

Twin bed comes with only one drawer.



a



b

Includes entire bed.



c



d

Includes entire bed.



e

Wood frame version available.

f

Includes entire bed.

a Auburn Bay Planked Bed

Headboard: 56" h; Footboard: 18" h

CA King	76½" w x 87½" d	SBABR-23B1
King	80½" w x 83½" d	SBABR-23B2
Queen	64½" w x 83½" d	SBABR-23B3
Full	58½" w x 79½" d	SBABR-23B4
Twin	43½" w x 79½" d	SBABR-23B5

b Auburn Bay Planked Bed with Footboard Storage

Headboard: 56" h; Footboard: 18" h

CA King	76½" w x 87½" d	SBABR-23F1
King	80½" w x 83½" d	SBABR-23F2
Queen	64½" w x 83½" d	SBABR-23F3
Full	58½" w x 79½" d	SBABR-23F4
Twin	43½" w x 79½" d	SBABR-23F5

Twin bed comes with only one drawer.

c Auburn Bay Single Panel Bed

Headboard: 56" h; Footboard: 18" h

CA King	76½" w x 87½" d	SBABR-22B1
King	80½" w x 83½" d	SBABR-22B2
Queen	64½" w x 83½" d	SBABR-22B3
Full	58½" w x 79½" d	SBABR-22B4
Twin	43½" w x 79½" d	SBABR-22B5

d Auburn Bay Single Panel Bed with Footboard Storage

Headboard: 56" h; Footboard: 18" h

CA King	76½" w x 87½" d	SBABR-22F1
King	80½" w x 83½" d	SBABR-22F2
Queen	64½" w x 83½" d	SBABR-22F3
Full	58½" w x 79½" d	SBABR-22F4
Twin	43½" w x 79½" d	SBABR-22F5

Twin bed comes with only one drawer.

e B&O Railroad® Trestle Bridge Panel Bed

Headboard: 53" h; Footboard: 30" h

CA King	84" w x 91" d	SBTRB-05B1
King	88" w x 87" d	SBTRB-05B2
Queen	72" w x 87" d	SBTRB-05B3
Full	66" w x 83" d	SBTRB-05B4
Twin	51" w x 83" d	SBTRB-05B5

f B&O Railroad® Trestle Bridge Panel Bed with Footboard Storage

Headboard: 53" h; Footboard: 18½" h

CA King	84" w x 91" d	SBTRB-05F1
King	88" w x 87" d	SBTRB-05F2
Queen	72" w x 87" d	SBTRB-05F3
Full	66" w x 83" d	SBTRB-05F4
Twin	51" w x 83" d	SBTRB-05F5

Twin bed comes with only one drawer.



Wood frame version available.

a



Wood frame version available.

b



Wood frame version available.

Upholstered headboard option available.

c



Wood frame version available.

Upholstered headboard option available.

d



e



f

Includes entire bed.

a Beaumont Panel Bed

Headboard: 49" h; Footboard: 20" h

CA King	76½" w x 87½" d	SBBEU-05B1
King	80½" w x 83½" d	SBBEU-05B2
Queen	64½" w x 83½" d	SBBEU-05B3
Full	58½" w x 79½" d	SBBEU-05B4
Twin	43½" w x 79½" d	SBBEU-05B5

b Belvedere Panel Bed

Headboard: 53" h; Footboard: 24½" h

CA King	80½" w x 92½" d	SBBEV-05B1
King	84½" w x 88½" d	SBBEV-05B2
Queen	68½" w x 88½" d	SBBEV-05B3
Full	62½" w x 84½" d	SBBEV-05B4
Twin	48½" w x 84½" d	SBBEV-05B5

c Braden Panel Bed

Headboard: 49" h; Footboard: 21" h

CA King	77" w x 92" d	SBBRD-05B1
King	81" w x 88" d	SBBRD-05B2
Queen	65" w x 88" d	SBBRD-05B3
Full	59" w x 84" d	SBBRD-05B4
Twin	45" w x 84" d	SBBRD-05B5

d Colburn Panel Bed

Headboard: 54¾" h; Footboard: 28"

CA King	80½" w x 93½" d	SBCBN-05B1
King	84½" w x 89½" d	SBCBN-05B2
Queen	68½" w x 89½" d	SBCBN-05B3
Full	62½" w x 85½" d	SBCBN-05B4
Twin	47½" w x 85½" d	SBCBN-05B5

Twin size design features a single panel.

e Crawford Single Panel Bed

Headboard: 60" h; Footboard: 18" h

CA King	79¼" w x 87¼" d	SBCRA-05B1
King	83¼" w x 83¼" d	SBCRA-05B2
Queen	67¼" w x 83¼" d	SBCRA-05B3
Full	61¼" w x 79¼" d	SBCRA-05B4
Twin	46¼" w x 79¼" d	SBCRA-05B5

f Crawford Single Panel Bed with Footboard Storage

Headboard: 60" h; Footboard: 18" h

CA King	79¼" w x 87¼" d	SBCRA-05F1
King	83¼" w x 83¼" d	SBCRA-05F2
Queen	67¼" w x 83¼" d	SBCRA-05F3
Full	61¼" w x 79¼" d	SBCRA-05F4
Twin	46¼" w x 79¼" d	SBCRA-05F5

Twin bed comes with only one drawer.



a



b



c



d



e



f

a Dovetail Bed

Headboard: 47" h; Footboard: 24" h

CA King	74½" w x 92" d	SBD0V-05B1
King	78½" w x 88" d	SBD0V-05B2
Queen	62½" w x 88" d	SBD0V-05B3
Full	56½" w x 84" d	SBD0V-05B4
Twin	41½" w x 84" d	SBD0V-05B5

b Elroy Panel Bed

Headboard: 36" h

CA King	74½" w x 93" d	SBELR-05B1
King	78½" w x 89" d	SBELR-05B2
Queen	62½" w x 89" d	SBELR-05B3
Full	56½" w x 85" d	SBELR-05B4
Twin	41½" w x 85" d	SBELR-05B5

2-Tone Standard; Rolled Slats Standard.

c Frisco Panel Bed

Headboard: 48¾" h; Footboard: 15¾" h

CA King	83½" w x 89½" d	BBFRI-05B1
King	87½" w x 85½" d	BBFRI-05B2
Queen	71½" w x 85½" d	BBFRI-05B3
Full	65½" w x 81½" d	BBFRI-05B4
Twin	44½" w x 81½" d	BBFRI-05B5

d Frisco Panel Bed with 26" Attached Nightstands

Headboard: 48¾" h; Footboard: 15¾" h

CA King	135½" w x 89½" d	BBFRI-14B1
King	139½" w x 85½" d	BBFRI-14B2
Queen	123½" w x 85½" d	BBFRI-14B3
Full	117½" w x 81½" d	BBFRI-14B4
Twin	98½" w x 81½" d	BBFRI-14B5

e Frisco Panel Bed with 18" Attached Nightstands with No Upper Panel

Headboard: 48¾" h

CA King	119½" w x 89½" d	BBFRI-37B1
King	101½" w x 81½" d	BBFRI-37B2
Queen	123½" w x 85½" d	BBFRI-37B3
Full	107½" w x 85½" d	BBFRI-37B4
Twin	82½" w x 81½" d	BBFRI-37B5

f Garrett Headboard with Wood Frame

Headboard: 48" h; Footboard: 18½" h

CA King	79½" w x 87¾" d	SBGAR-05W1
King	83½" w x 83¾" d	SBGAR-05W2
Queen	67½" w x 83¾" d	SBGAR-05W3
Full	61½" w x 79¾" d	SBGAR-05W4
Twin	46½" w x 79¾" d	SBGAR-05W5



a

Includes entire bed.



b

Wood frame version available.



c

NEW

Wood frame version available.



d

Wood frame version available.



e

Wood frame version available.



f

Wood frame version available.

a Garrett Panel Bed with Footboard Storage

Headboard: 49" h; Footboard: 18½" h

CA King	79½" w x 87¾" d	SBGAR-05F1
King	83½" w x 83¾" d	SBGAR-05F2
Queen	67½" w x 83¾" d	SBGAR-05F3
Full	61½" w x 79¾" d	SBGAR-05F4
Twin	46½" w x 79¾" d	SBGAR-05F5

Twin bed comes with only one drawer.

b Georgia Panel Bed

Headboard: 54" h; Footboard: 33¾" h

CA King	78" w x 92" d	SBGEO-05B1
King	82" w x 88" d	SBGEO-05B2
Queen	66" w x 88" d	SBGEO-05B3
Full	60" w x 84" d	SBGEO-05B4
Twin	46" w x 84" d	SBGEO-05B5

Twin size design features a single panel

c Haley Bed

Headboard: 52" h; Footboard: 23¾" h

CA King	77" w x 90¼" d	SBHAL-05B1
King	81" w x 86¼" d	SBHAL-05B2
Queen	65" w x 86¼" d	SBHAL-05B3
Full	59" w x 82¼" d	SBHAL-05B4
Twin	44" w x 82¼" d	SBHAL-05B5

d Hamptons Panel Bed

Headboard: 53½" h; Footboard: 25¼" h

CA King	76" w x 90½" d	SBHAP-05B1
King	80" w x 86½" d	SBHAP-05B2
Queen	64" w x 86½" d	SBHAP-05B3
Full	58" w x 82½" d	SBHAP-05B4
Twin	43" w x 82½" d	SBHAP-05B5

e Hamptons Curved Panel Bed

Headboard: 53½" h; Footboard: 25¼" h

CA King	75½" w x 89" d	SBHAP-27B1
King	79½" w x 85" d	SBHAP-27B2
Queen	63½" w x 85" d	SBHAP-27B3
Full	57½" w x 81" d	SBHAP-27B4
Twin	42½" w x 81" d	SBHAP-27B5

f Hamptons Split Panel Bed

Headboard: 49¾" h; Footboard: 22" h;

CA King	75½" w x 89" d	SBHAP-29B1
King	79½" w x 85" d	SBHAP-29B2
Queen	63½" w x 85" d	SBHAP-29B3
Full	57½" w x 81" d	SBHAP-29B4
Twin	42½" w x 81" d	SBHAP-29B5



Wood frame version available.

a



Wood frame version available.

b



c



d

Includes entire bed.



Wood frame version available.
Upholstered headboard option available.

e



f

Includes entire bed.

a Homestead Raised Panel Bed

Headboard: 50" h; Footboard: 33" h

CA King	78" w x 94" d	SBHME-05B1
King	82" w x 90" d	SBHME-05B2
Queen	66" w x 90" d	SBHME-05B3
Full	60" w x 86" d	SBHME-05B4
Twin	46" w x 86" d	SBHME-05B5

b Imperial Panel Bed

Headboard: 50½" h; Footboard: 27" h

CA King	82" w x 91" d	SBIM3-05B1
King	86" w x 87" d	SBIM3-05B2
Queen	70" w x 87" d	SBIM3-05B3
Full	64" w x 83" d	SBIM3-05B4
Twin	49" w x 83" d	SBIM3-05B5

c Ironwood Planked Bed

Headboard: 54" h; Footboard: 14½" h

CA King	77½" w x 87½" d	SBIRN-23B1
King	81½" w x 83½" d	SBIRN-23B2
Queen	65½" w x 83½" d	SBIRN-23B3
Full	59½" w x 79½" d	SBIRN-23B4
Twin	44½" w x 79½" d	SBIRN-23B5

d Ironwood Planked Storage Bed

Headboard: 54" h; Footboard: 14½" h

CA King	77½" w x 87½" d	SBIRN-26S1
King	81½" w x 83½" d	SBIRN-26S2
Queen	65½" w x 83½" d	SBIRN-26S3
Full	59½" w x 79½" d	SBIRN-26S4
Twin	44½" w x 79½" d	SBIRN-26S5

e Justine Panel Bed

Headboard: 54" h; Footboard: 28½" h

CA King	77" w x 91" d	SBJUS-05B1
King	81" w x 87" d	SBJUS-05B2
Queen	65" w x 87" d	SBJUS-05B3
Full	59" w x 83" d	SBJUS-05B4
Twin	45" w x 83" d	SBJUS-05B5

f Justine Panel Bed with Footboard Storage

Headboard: 54" h; Footboard: 18½" h

CA King	76½" w x 90" d	SBJUS-05F1
King	80½" w x 86" d	SBJUS-05F2
Queen	64½" w x 86" d	SBJUS-05F3
Full	58½" w x 82" d	SBJUS-05F4
Twin	43½" w x 82" d	SBJUS-05F5

Twin bed comes with only one drawer.



NEW

Wood frame version available.

a



Wood frame version available.

b



Wood frame version available.
Upholstered headboard option available.

c



Wood frame version available.
Upholstered headboard option available.

d



Upholstered headboard option available.

e

Includes entire bed.



Wood frame version available.

f

a Kodiak Bed

Headboard: 54" h; Footboard: 26" h

CA King	76 3/4" w x 90" d	SBKOD-05B1
King	80 3/4" w x 86" d	SBKOD-05B2
Queen	64 3/4" w x 86" d	SBKOD-05B3
Full	58 3/4" w x 82" d	SBKOD-05B4
Twin	43 3/4" w x 82" d	SBKOD-05B5

b Lexington Bed

Headboard: 52 1/2" h; Footboard: 33" h

CA King	78" w x 90 1/2" d	SBLEX-05B1
King	82" w x 86 1/2" d	SBLEX-05B2
Queen	66" w x 86 1/2" d	SBLEX-05B3
Full	60" w x 82 1/2" d	SBLEX-05B4
Twin	45" w x 82 1/2" d	SBLEX-05B5

c Loft Panel Bed

Headboard: 55" h; Footboard: 25" h

CA King	81" w x 92" d	SBLF2-05B1
King	85" w x 88" d	SBLF2-05B2
Queen	69" w x 88" d	SBLF2-05B3
Full	63" w x 84" d	SBLF2-05B4
Twin	48" w x 84" d	SBLF2-05B5

d Loft II Panel Bed

Headboard: 55" h; Footboard: 33" h

CA King	78 3/4" w x 89" d	SBLF2-05B1
King	82 3/4" w x 85" d	SBLF2-05B2
Queen	66 3/4" w x 85" d	SBLF2-05B3
Full	60 3/4" w x 81" d	SBLF2-05B4
Twin	45 3/4" w x 81" d	SBLF2-05B5

e Loft II Panel Bed with Footboard Storage

Headboard: 55" h; Footboard: 18 1/2" h

CA King	79" w x 87 1/2" d	SBLF2-05F1
King	83" w x 83 1/2" d	SBLF2-05F2
Queen	67" w x 83 1/2" d	SBLF2-05F3
Full	61" w x 79 1/2" d	SBLF2-05F4
Twin	46" w x 79 1/2" d	SBLF2-05F5

Twin bed comes with only one drawer.

f Louis Philippe Panel Bed

Headboard: 55" h; Footboard: 27" h

CA King	80" w x 93" d	SBLPP-05B1
King	84" w x 89" d	SBLPP-05B2
Queen	68" w x 89" d	SBLPP-05B3
Full	62" w x 85" d	SBLPP-05B4
Twin	48" w x 85" d	SBLPP-05B5



a MäKayla Bed

Headboard: 65 $\frac{3}{4}$ "h; Footboard: 31 $\frac{3}{4}$ "h
 CA King 83"w x 94"d SBMAK-05B1
 King 87"w x 90"d SBMAK-05B2
 Queen 71"w x 90"d SBMAK-05B3
 Full 65"w x 86"d SBMAK-05B4
 Twin 51"w x 86"d SBMAK-05B5

b MäKayla Grande Bed

Headboard: 72"h; Footboard: 39"h
 CA King 86 $\frac{3}{4}$ "w x 101"d SBMKG-05B1
 King 90 $\frac{3}{4}$ "w x 97"d SBMKG-05B2
 Queen 74 $\frac{3}{4}$ "w x 97"d SBMKG-05B3

c MäRia Bed

Headboard: 65 $\frac{3}{4}$ "h; Footboard: 31 $\frac{3}{4}$ "h
 CA King 82 $\frac{3}{4}$ "w x 95"d SBMAR-05B1
 King 86 $\frac{3}{4}$ "w x 91"d SBMAR-05B2
 Queen 70 $\frac{3}{4}$ "w x 91"d SBMAR-05B3
 Full 64 $\frac{3}{4}$ "w x 87"d SBMAR-05B4
 Twin 50 $\frac{3}{4}$ "w x 87"d SBMAR-05B5

d MäRyan Panel Bed

Headboard: 59 $\frac{3}{4}$ "h; Footboard: 32"h
 CA King 83"w x 95"d SBMRY-05B1
 King 87"w x 91"d SBMRY-05B2
 Queen 71"w x 91"d SBMRY-05B3
 Full 65"w x 87"d SBMRY-05B4
 Twin 50"w x 87"d SBMRY-05B5

e McCoy Panel Bed

Headboard: 50"h; Footboard: 28"h
 CA King 78 $\frac{1}{2}$ "w x 96"d SBMCC-05B1
 King 82 $\frac{1}{2}$ "w x 92"d SBMCC-05B2
 Queen 66 $\frac{1}{2}$ "w x 92"d SBMCC-05B3
 Full 60 $\frac{1}{2}$ "w x 88"d SBMCC-05B4
 Twin 45 $\frac{1}{2}$ "w x 88"d SBMCC-05B5

f Meridian Bed

Headboard: 48"h; Footboard: 33"h
 CA King 76 $\frac{1}{2}$ "w x 89 $\frac{1}{2}$ "d SBMER-05B1
 King 80 $\frac{1}{2}$ "w x 85 $\frac{1}{2}$ "d SBMER-05B2
 Queen 64 $\frac{1}{2}$ "w x 85 $\frac{1}{2}$ "d SBMER-05B3
 Full 58 $\frac{1}{2}$ "w x 81 $\frac{1}{2}$ "d SBMER-05B4
 Twin 43 $\frac{1}{2}$ "w x 81 $\frac{1}{2}$ "d SBMER-05B5



Wood frame version available.

a



Wood frame version available.

b



Wood frame version available.

c



Includes entire bed.

d



Wood frame version available.

e



f

a Monarch Panel Bed

Headboard: 60" h; Footboard: 33" h

CA King	76½" w x 89½" d	SBMON-05B1
King	80½" w x 85½" d	SBMON-05B2
Queen	64½" w x 85½" d	SBMON-05B3
Full	58½" w x 81½" d	SBMON-05B4
Twin	44½" w x 81½" d	SBMON-05B5

b Monarch II Panel Bed

Headboard: 60" h; Footboard: 33" h

CA King	76½" w x 89½" d	SBM02-05B1
King	80½" w x 85½" d	SBM02-05B2
Queen	64½" w x 85½" d	SBM02-05B3
Full	58½" w x 81½" d	SBM02-05B4
Twin	44½" w x 81½" d	SBM02-05B5

c Montauk 2-Panel Bed

Headboard: 58" h; Footboard: 26" h;
Rough Sawn Standard

CA King	78½" w x 87½" d	SBMOK-21B1
King	82½" w x 83½" d	SBMOK-21B2
Queen	66½" w x 83½" d	SBMOK-21B3
Full	60½" w x 79½" d	SBMOK-21B4
Twin	45½" w x 79½" d	SBMOK-21B5

d Montauk 2-Panel Bed with Footboard Storage

Headboard: 58" h; Rough Sawn Standard

CA King	78½" w x 87½" d	SBMOK-21F1
King	82½" w x 83½" d	SBMOK-21F2
Queen	66½" w x 83½" d	SBMOK-21F3
Full	60½" w x 79½" d	SBMOK-21F4
Twin	45½" w x 79½" d	SBMOK-21F5

Twin bed comes with only one drawer.

e Naomi Panel Bed

Headboard: 55" h; Footboard: 14¾" h

CA King	82¾" w x 92¾" d	SBNA0-05B1
King	86¾" w x 88¾" d	SBNA0-05B2
Queen	70¾" w x 88¾" d	SBNA0-05B3
Full	64¾" w x 84¾" d	SBNA0-05B4
Twin	49¾" w x 84¾" d	SBNA0-05B5

f Parkdale 2-Panel Bed

Headboard: 56" h; Footboard: 20" h

CA King	77½" w x 87½" d	SBPAR-21B1
King	81½" w x 83½" d	SBPAR-21B2
Queen	65½" w x 83½" d	SBPAR-21B3
Full	59½" w x 79½" d	SBPAR-21B4
Twin	44½" w x 79½" d	SBPAR-21B5



a Includes entire bed.



Wood frame version available.



c Shown with optional Under-Bed Storage. Wood frame version available.



Wood frame version available.



e



f Includes entire bed.

a Parkdale 2-Panel Bed with Footboard Storage
 Headboard: 56"h; Footboard: 20"h
 CA King 77½"w x 87½"d SBPAR-21F1
 King 81½"w x 83½"d SBPAR-21F2
 Queen 65½"w x 83½"d SBPAR-21F3
 Full 59½"w x 79½"d SBPAR-21F4
 Twin 44½"w x 79½"d SBPAR-21F5
 Twin bed comes with only one drawer.

b Prairie Mission II Panel Bed
 Headboard: 65"h; Footboard: 36"h
 CA King 77½"w x 90½"d SBPM2-05B1
 King 81½"w x 86½"d SBPM2-05B2
 Queen 66"w x 87"d SBPM2-05B3
 Full 59½"w x 83"d SBPM2-05B4
 Twin 44½"w x 83"d SBPM2-05B5

c Raised-Panel Bed
 Headboard: 50"h; Footboard: 33"h
 CA King 78½"w x 92"d SBRPB-05B1
 King 82½"w x 88"d SBRPB-05B2
 Queen 66½"w x 88"d SBRPB-05B3
 Full 60½"w x 84"d SBRPB-05B4
 Twin 45½"w x 84"d SBRPB-05B5

d Royal Mission Panel Bed with Walnut Inlay
 Headboard: 50"h; Footboard: 33"h
 CA King 82½"w x 90½"d SBRMS-05B1
 King 86½"w x 86½"d SBRMS-05B2
 Queen 71½"w x 86½"d SBRMS-05B3
 Full 64"w x 82½"d SBRMS-05B4
 Twin 49"w x 82½"d SBRMS-05B5

e San Miguel Panel Headboard with Wood Frame

 Headboard: 48"h; Footboard: 13½"h
 CA King 82½"w x 88"d SBMIG-05W1
 King 86½"w x 84"d SBMIG-05W2
 Queen 70½"w x 84"d SBMIG-05W3
 Full 64½"w x 80"d SBMIG-05W4
 Twin 49½"w x 80"d SBMIG-05W5

f San Miguel Panel Bed with Footboard Storage
 Headboard: 48"h; Footboard: 18½"h
 CA King 82½"w x 88"d SBMIG-05F1
 King 86½"w x 84"d SBMIG-05F2
 Queen 70½"w x 84"d SBMIG-05F3
 Full 64½"w x 80"d SBMIG-05F4
 Twin 49½"w x 80"d SBMIG-05F5
 Twin bed comes with only one drawer.



Wood frame version available.

a



Wood frame version available.

b



c



d

Includes entire bed.



e



f

a Savannah Panel Bed

Headboard: 61½" h (posts 55¼" h)

Footboard: 34¾" h (posts 33¼" h)

CA King	78" w x 92" d	SBSAV-05B1
King	82" w x 88" d	SBSAV-05B2
Queen	66" w x 88" d	SBSAV-05B3
Full	60" w x 84" d	SBSAV-05B4
Twin	45" w x 84" d	SBSAV-05B5

b Shaker Panel Bed

Headboard: 55" h; Footboard: 25" h

CA King	78½" w x 92" d	SBSHK-05B1
King	82½" w x 88" d	SBSHK-05B2
Queen	66½" w x 88" d	SBSHK-05B3
Full	60½" w x 84" d	SBSHK-05B4
Twin	45½" w x 84" d	SBSHK-05B5

c Sheffield Headboard with Wood Frame

Headboard: 47¾" h

CA King	77¼" w x 87¾" d	SBSHE-05W1
King	81¼" w x 83¾" d	SBSHE-05W2
Queen	65¼" w x 83¾" d	SBSHE-05W3
Full	59¼" w x 79¾" d	SBSHE-05W4
Twin	44¼" w x 79¾" d	SBSHE-05W5

d Sheffield Bed with Footboard Storage

Headboard: 47¾" h

CA King	77¼" w x 87¾" d	SBSHE-05F1
King	81¼" w x 83¾" d	SBSHE-05F2
Queen	65¼" w x 83¾" d	SBSHE-05F3
Full	59¼" w x 79¾" d	SBSHE-05F4
Twin	44¼" w x 79¾" d	SBSHE-05F5

Twin bed comes with only one drawer.

e Shenandoah Bed

Headboard: 48" h; Footboard: 24" h

CA King	78" w x 88¾" d	SBSHS-05B1
King	82" w x 84¾" d	SBSHS-05B2
Queen	66" w x 84¾" d	SBSHS-05B3
Full	60" w x 80¾" d	SBSHS-05B4
Twin	45" w x 80¾" d	SBSHS-05B5

f Shenandoah Headboard with Wood Frame

Headboard: 48" h; Footboard: 13½" h

CA King	78" w x 87½" d	SBSHS-05W1
King	82" w x 83½" d	SBSHS-05W2
Queen	66" w x 83½" d	SBSHS-05W3
Full	60" w x 79½" d	SBSHS-05W4
Twin	45" w x 79½" d	SBSHS-05W5



Includes entire bed.



b



Includes entire bed.



Wood frame version available.



Wood frame version available.



Wood frame version available.

a Shenandoah Bed with Footboard Storage
 Headboard: 48" h; Footboard: 18½" h
 CA King 78" w x 87½" d SBSHS-05F1
 King 82" w x 83½" d SBSHS-05F2
 Queen 66" w x 83½" d SBSHS-05F3
 Full 60" w x 79½" d SBSHS-05F4
 Twin 45" w x 79½" d SBSHS-05F5
 Twin bed comes with only one drawer.

b Shenandoah Deluxe Headboard with Wood Frame
 Headboard: 58¼" h; Footboard: 13½" h
 CA King 81" w x 87½" d SBSHD-05W1
 King 85" w x 83½" d SBSHD-05W2
 Queen 69" w x 83½" d SBSHD-05W3
 Full 63" w x 79½" d SBSHD-05W4
 Twin 48" w x 79½" d SBSHD-05W5

c Shenandoah Deluxe Bed with Footboard Storage
 Headboard: 58¼" h; Footboard: 18½" h
 CA King 81" w x 87½" d SBSHD-05F1
 King 85" w x 83½" d SBSHD-05F2
 Queen 69" w x 83½" d SBSHD-05F3
 Full 63" w x 79½" d SBSHD-05F4
 Twin 48" w x 79½" d SBSHD-05F5
 Twin bed comes with only one drawer.

d Sophia Bed
 Headboard: 56½" h; Footboard: 33" h
 CA King 82½" w x 96" d SBSF1-05B1
 King 86½" w x 92" d SBSF1-05B2
 Queen 70½" w x 92" d SBSF1-05B3
 Full 64½" w x 88" d SBSF1-05B4
 Twin 49½" w x 88" d SBSF1-05B5
 Not available with Under-Bed Storage

e Sophia Panel Bed
 Headboard: 56½" h; Footboard: 33" h
 CA King 82½" w x 96" d SBSF2-05B1
 King 86½" w x 92" d SBSF2-05B2
 Queen 70½" w x 92" d SBSF2-05B3
 Full 64½" w x 88" d SBSF2-05B4
 Twin 49½" w x 88" d SBSF2-05B5
 Not available with Under-Bed Storage

f Stamford Bed
 Headboard: 54" h; Footboard: 33" h
 CA King 78½" w x 92" d SBSTM-05B1
 King 82½" w x 88" d SBSTM-05B2
 Queen 66½" w x 88" d SBSTM-05B3
 Full 60½" w x 84" d SBSTM-05B4
 Twin 45½" w x 84" d SBSTM-05B5



Rolled slats — Standard.



Includes entire bed.



a Wildwood Bed

Headboard: 48½”h

CA King	76”w x 88½”d	SBWIL-23B1
King	80”w x 84½”d	SBWIL-23B2
Queen	64”w x 84½”d	SBWIL-23B3
Full	58”w x 80½”d	SBWIL-23B4
Twin	53”w x 80½”d	SBWIL-23B5

Rolled Slats Standard.

b Wildwood Bed with Footboard Storage

Headboard: 48½”h

CA King	76”w x 88½”d	SBWIL-23F1
King	80”w x 84½”d	SBWIL-23F2
Queen	64”w x 84½”d	SBWIL-23F3
Full	58”w x 80½”d	SBWIL-23F4
Twin	53”w x 80½”d	SBWIL-23F5

Twin bed comes with only one drawer.

c Yuma Headboard with Wood Frame

Headboard: 50¾”h

CA King	83¾”w x 88½”d	SBYUM-05W1
King	80¾”w x 84½”d	SBYUM-05W2
Queen	78¾”w x 84½”d	SBYUM-05W3
Full	66¾”w x 80½”d	SBYUM-05W4
Twin	51¾”w x 80½”d	SBYUM-05W5

d Live Edge Headboard with Wood Frame

Headboard: 51”h (Height may vary)

CA King	80”w x 89½”d	BBLIV-28W1
King	84”w x 85½”d	BBLIV-28W2
Queen	68”w x 85½”d	BBLIV-28W3
Full	62”w x 81½”d	BBLIV-28W4
Twin	57”w x 81½”d	BBLIV-28W5

e Justine Panel Platform Bed

Headboard: 41”h; Platform: 8”h

CA King	80”w x 91”d	SBJUS-05P1
King	84”w x 87”d	SBJUS-05P2
Queen	68”w x 87”d	SBJUS-05P3
Full	62”w x 83”d	SBJUS-05P4
Twin	47”w x 83”d	SBJUS-05P5

Rolled Slats Standard.

f Naomi Platform Bed

Headboard: 46”h; Platform: 7¾”h

CA King	82¾”w x 90¾”d	SBNAO-05P1
King	86¾”w x 86¾”d	SBNAO-05P2
Queen	70¾”w x 86¾”d	SBNAO-05P3
Full	64¾”w x 82¾”d	SBNAO-05P4
Twin	49¾”w x 82¾”d	SBNAO-05P5

Rolled Slats Standard.



a



b

Shown with optional 1" canopy – SBHAP-0-CAN



c



d

- a Arch Top Poster Bed**
 Headboard: 49" h; Posts: 83½" h
- | | | |
|---------|---------------|------------|
| CA King | 77" w x 91" d | SBATB-07B1 |
| King | 81" w x 87" d | SBATB-07B2 |
| Queen | 65" w x 87" d | SBATB-07B3 |
| Full | 59" w x 83" d | SBATB-07B4 |
| Twin | 44" w x 83" d | SBATB-07B5 |
- b Hamptons Curved Pencil Post Bed**
 Headboard: 53½" h; Footboard: 25¼" h; Post: 80"
- | | | |
|---------|----------------|------------|
| CA King | 75½" w x 89" d | SBHAP-32B1 |
| King | 79½" w x 85" d | SBHAP-32B2 |
| Queen | 63½" w x 85" d | SBHAP-32B3 |
| Full | 57½" w x 81" d | SBHAP-32B4 |
| Twin | 42½" w x 81" d | SBHAP-32B5 |

- c Hamptons Panel Pencil Post Bed**
 Headboard: 53½" h; Footboard: 25¼" h; Post: 80"
- | | | |
|---------|----------------|------------|
| CA King | 76" w x 90½" d | SBHAP-30B1 |
| King | 80" w x 86½" d | SBHAP-30B2 |
| Queen | 64" w x 86½" d | SBHAP-30B3 |
| Full | 58" w x 82½" d | SBHAP-30B4 |
| Twin | 43" w x 82½" d | SBHAP-30B5 |
- d Hamptons Split Pencil Post Bed**
 Headboard: 49¾" h; Footboard: 22" h; Post: 80"
- | | | |
|---------|----------------|------------|
| CA King | 75½" w x 89" d | SBHAP-31B1 |
| King | 79½" w x 85" d | SBHAP-31B2 |
| Queen | 63½" w x 85" d | SBHAP-31B3 |
| Full | 57½" w x 81" d | SBHAP-31B4 |
| Twin | 42½" w x 81" d | SBHAP-31B5 |
- Shown with optional canopy – SBHAP-0-CAN



Shown with optional straight canopy — KAOSC



a MäKayla Grande Poster Bed

Headboard: 79”h; Footboard: 79”h

CA King	86¾”w x 101”d	SBMKG-07B1
King	90¾”w x 97”d	SBMKG-07B2
Queen	74¾”w x 97”d	SBMKG-07B3

b Savannah Poster Bed

Headboard: 61½”h(posts 80”h)

Footboard: 34¾”h (posts 80”h)

CA King	78”w x 92”d	SBSAV-02B1
King	82”w x 88”d	SBSAV-02B2
Queen	66”w x 88”d	SBSAV-02B3
Full	60”w x 84”d	SBSAV-02B4
Twin	45”w x 84”d	SBSAV-02B5

c Shaker Pencil Post Bed

Headboard: 46¾”h; Posts: 81½”h

CA King	77”w x 90”d	SBSHK-07B1
King	81”w x 86”d	SBSHK-07B2
Queen	65”w x 86”d	SBSHK-07B3
Full	59”w x 82”d	SBSHK-07B4
Twin	44”w x 82”d	SBSHK-07B5

d Wildwood Canopy Bed

Headboard: 48½”h; Posts: 90”h

CA King	77”w x 88½”d	SBWIL-24B1
King	81”w x 84½”d	SBWIL-24B2
Queen	65”w x 84½”d	SBWIL-24B3
Full	59”w x 80½”d	SBWIL-24B4
Twin	54”w x 80½”d	SBWIL-24B5

King and California King will ship disassembled.
Rolled Slats Standard.



a



b



c



d



e

a Arch Mission Bed

Headboard: 50" h; Footboard: 27" h

CA King	78½" w x 92" d	SBARM-08B1
King	82½" w x 88" d	SBARM-08B2
Queen	66¼" w x 88" d	SBARM-08B3
Full	60¼" w x 84" d	SBARM-08B4
Twin	45¼" w x 84" d	SBARM-08B5

b Aspen Slat Bed with Inlay

Headboard: 50" h; Footboard: 31" h

CA King	78½" w x 93" d	SBASP-10B1
King	82½" w x 89" d	SBASP-10B2
Queen	66½" w x 89" d	SBASP-10B3
Full	60½" w x 85" d	SBASP-10B4
Twin	45½" w x 85" d	SBASP-10B5

c Colorado Mission Bed

Headboard: 48" h; Footboard: 33" h

CA King	76½" w x 89½" d	SBCOL-08B1
King	80½" w x 85½" d	SBCOL-08B2
Queen	64½" w x 85½" d	SBCOL-08B3
Full	58½" w x 81½" d	SBCOL-08B4
Twin	43½" w x 81½" d	SBCOL-08B5

d Durango Bed

Headboard: 53¼" h; Footboard: 33" h

CA King	76¼" w x 90" d	SBDUR-08B1
King	80¼" w x 86" d	SBDUR-08B2
Queen	64¼" w x 86" d	SBDUR-08B3
Full	58½" w x 82" d	SBDUR-08B4
Twin	43½" w x 82" d	SBDUR-08B5

e East Village Bed

Headboard: 49" h; Footboard: 14" h

CA King	77" w x 90" d	SBESV-10B1
King	81" w x 86" d	SBESV-10B2
Queen	65" w x 86" d	SBESV-10B3
Full	59" w x 82" d	SBESV-10B4
Twin	44" w x 82" d	SBESV-10B5



The main color block is red by default. When selecting the other choices only the main color block changes — the rest of the color panels remain the same.

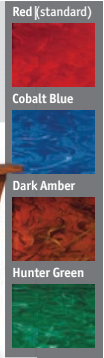

a

b



c

d



e

f

a Grant Slat Bed

Headboard: 55½" h; Footboard: 29½" h

CA King	85" w x 91" d	SBGRA-08B1
King	89" w x 87" d	SBGRA-08B2
Queen	73" w x 87" d	SBGRA-08B3
Full	67" w x 83" d	SBGRA-08B4
Twin	53" w x 83" d	SBGRA-08B5

c Justine Slat Bed

Headboard: 53" h; Footboard: 29" h

CA King	77" w x 89" d	SBJUS-08B1
King	81" w x 85" d	SBJUS-08B2
Queen	65" w x 85" d	SBJUS-08B3
Full	59" w x 81" d	SBJUS-08B4
Twin	45" w x 81" d	SBJUS-08B5

e Mission Paneled Slat Bed

Headboard: 50" h; Footboard: 30¾" h

CA King	84½" w x 92" d	SBMIS-05B1
King	88½" w x 88" d	SBMIS-05B2
Queen	72½" w x 88" d	SBMIS-05B3
Full	66½" w x 84" d	SBMIS-05B4
Twin	51½" w x 84" d	SBMIS-05B5

b Grant Slat Bed with Stained Glass

Headboard: 61½" h; Footboard: 29½" h

CA King	85" w x 91" d	SBGRG-08B1
King	89" w x 87" d	SBGRG-08B2
Queen	73" w x 87" d	SBGRG-08B3
Full	67" w x 83" d	SBGRG-08B4
Twin	51" w x 83" d	SBGRG-08B5

d Loft Slat Bed

Headboard: 55" h; Footboard: 33" h

CA King	78¾" w x 89" d	SBLFT-10B1
King	82¾" w x 85" d	SBLFT-10B2
Queen	66¾" w x 85" d	SBLFT-10B3
Full	60¾" w x 81" d	SBLFT-10B4
Twin	45¾" w x 81" d	SBLFT-10B5

f Prairie Mission Slat Bed

Headboard: 50" h; Footboard: 36" h

CA King	84½" w x 92" d	SBPMS-10B1
King	88½" w x 88" d	SBPMS-10B2
Queen	72½" w x 88" d	SBPMS-10B3
Full	66½" w x 84" d	SBPMS-10B4
Twin	51½" w x 84" d	SBPMS-10B5



a



b



c



d



e



f

a Prairie Mission Paneled Slat Bed

Headboard: 50" h; Footboard: 30 3/4" h

CA King	84 1/2" w x 92" d	SBPMS-05B1
King	88 1/2" w x 88" d	SBPMS-05B2
Queen	72 1/2" w x 88" d	SBPMS-05B3
Full	66 1/2" w x 84" d	SBPMS-05B4
Twin	51 1/2" w x 84" d	SBPMS-05B5

b Ryan Slat Bed

Headboard: 60" h; Footboard: 32" h

CA King	83" w x 95" d	SBRYN-08B1
King	87" w x 91" d	SBRYN-08B2
Queen	71" w x 91" d	SBRYN-08B3
Full	67" w x 87" d	SBRYN-08B4
Twin	51" w x 87" d	SBRYN-08B5

c Appalachian Bed

Headboard: 54" h; Footboard: 36" h

CA King	76 3/4" w x 90 1/2" d	SBAP1-05B1
King	80 3/4" w x 86 1/2" d	SBAP1-05B2
Queen	64 3/4" w x 86 1/2" d	SBAP1-05B3
Full	58 3/4" w x 82 1/2" d	SBAP1-05B4
Twin	43 3/4" w x 82 1/2" d	SBAP1-05B5

d Plain Appalachian Bed

Headboard: 54" h; Footboard: 36" h

CA King	76 3/4" w x 90 1/2" d	SBAP2-05B1
King	80 3/4" w x 86 1/2" d	SBAP2-05B2
Queen	64 3/4" w x 86 1/2" d	SBAP2-05B3
Full	58 3/4" w x 82 1/2" d	SBAP2-05B4
Twin	43 3/4" w x 82 1/2" d	SBAP2-05B5

e Arch Top Bed

Posts: 46"; Headboard: 48" h; Footboard: 36" h

CA King	77" w x 91" d	SBATB-05B1
King	81" w x 87" d	SBATB-05B2
Queen	65" w x 87" d	SBATB-05B3
Full	59" w x 83" d	SBATB-05B4
Twin	44" w x 83" d	SBATB-05B5

f Cannonball Bed

Headboard: 46" h; Footboard: 36" h

CA King	77" w x 91" d	SBCAN-02B1
King	81" w x 87" d	SBCAN-02B2
Queen	65" w x 87" d	SBCAN-02B3
Full	59" w x 83" d	SBCAN-02B4
Twin	44" w x 83" d	SBCAN-02B5



a



b



c



d



e

a Arch Top Wrap-Around Bed

Headboard: 54" h; Footboard: 36" h

CA King	80½" w x 93½" d	SBATB-13B1
King	84½" w x 89½" d	SBATB-13B2
Queen	68½" w x 89½" d	SBATB-13B3
Full	62½" w x 85½" d	SBATB-13B4

b Arrow Bed

Headboard: 46" h; Footboard: 36" h

CA King	76½" w x 90" d	SBARW-10B1
King	80½" w x 86" d	SBARW-10B2
Queen	64½" w x 86" d	SBARW-10B3
Full	58½" w x 82" d	SBARW-10B4
Twin	43½" w x 82" d	SBARW-10B5

c Double Bow Bed

Headboard: 46" h; Footboard: 36" h

CA King	76½" w x 90" d	SBDBB-10B1
King	80½" w x 86" d	SBDBB-10B2
Queen	64½" w x 86" d	SBDBB-10B3
Full	58½" w x 82" d	SBDBB-10B4
Twin	43½" w x 82" d	SBDBB-10B5

d Spindle Bed

Headboard: 53½" h; Footboard: 36" h

CA King	76¾" w x 90½" d	SBSPN-10B1
King	80¾" w x 86½" d	SBSPN-10B2
Queen	64¾" w x 86½" d	SBSPN-10B3
Full	58¾" w x 82½" d	SBSPN-10B4
Twin	43¾" w x 82½" d	SBSPN-10B5

e Spindle Wrap-Around Bed

Headboard: 54" h; Footboard: 36" h

CA King	80½" w x 93½" d	SBSPW-13B1
King	84½" w x 89½" d	SBSPW-13B2
Queen	68½" w x 89½" d	SBSPW-13B3
Full	62½" w x 85½" d	SBSPW-13B4

Not available with Under-Bed Storage.

Wrap-Around and Sleigh Beds not available with Under-Bed Storage.



a



b



c



d



e



f

a Empire Sleigh Bed

Headboard: 52" h; Footboard: 32" h

CA King	75½" w x 96" d	SBEMP-09B1
King	79½" w x 92" d	SBEMP-09B2
Queen	63½" w x 92" d	SBEMP-09B3
Full	57½" w x 88" d	SBEMP-09B4
Twin	42½" w x 88" d	SBEMP-09B5

b Homestead Sleigh Bed

Headboard: 52" h; Footboard: 32" h

CA King	76" w x 98" d	SBHME-09B1
King	80" w x 94" d	SBHME-09B2
Queen	64" w x 94" d	SBHME-09B3
Full	58" w x 90" d	SBHME-09B4
Twin	44" w x 90" d	SBHME-09B5

c Imperial Sleigh Bed

Headboard: 55" h; Footboard: 27" h

CA King	76" w x 97" d	SBIMP-09B1
King	80" w x 93" d	SBIMP-09B2
Queen	64" w x 93" d	SBIMP-09B3
Full	58" w x 89" d	SBIMP-09B4
Twin	43" w x 89" d	SBIMP-09B5

d Louis Philippe Sleigh Bed

Headboard: 50½" h; Footboard: 25½" h

CA King	77" w x 96" d	SBLPP-09B1
King	81" w x 92" d	SBLPP-09B2
Queen	65" w x 92" d	SBLPP-09B3
Full	59" w x 88" d	SBLPP-09B4
Twin	45" w x 88" d	SBLPP-09B5

e Louis Philippe Sleigh Bed with Low Footboard

Headboard: 50½" h; Footboard: 18¾" h

CA King	77" w x 96" d	SBLPP-09L1
King	81" w x 92" d	SBLPP-09L2
Queen	65" w x 92" d	SBLPP-09L3
Full	59" w x 88" d	SBLPP-09L4
Twin	45" w x 88" d	SBLPP-09L5

f Savannah Sleigh Bed

Headboard: 56" h; Footboard: 27½" h

CA King	78" w x 94" d	SBSAV-09B1
King	82" w x 90" d	SBSAV-09B2
Queen	66" w x 90" d	SBSAV-09B3
Full	60" w x 86" d	SBSAV-09B4
Twin	46" w x 86" d	SBSAV-09B5

Sleigh Beds not available with Under-Bed Storage.



a



b



c

a McCoy Convertible Crib

57" w x 33" d x 45" h (as crib) MEM3WC
 57" w x 82" d x 45" h (as full-size bed)

Features rails to convert crib into a toddler bed or a full-size bed.

b Mission Convertible Crib

56½" w x 31" d x 45" h (as crib) OTMCC
 56½" w x 82" d x 45" h (as full-size bed)

Features rails to convert crib into a toddler bed or a full-size bed.

c Sleigh Convertible Crib

55" w x 38" d x 44" h (as crib) SAG3WC
 55" w x 88" d x 44" h (as full-size bed)

Features rails to convert crib into a toddler bed or a full-size bed.



a

Shown in Aspen style
Shown with Standard Lift Mechanism option
(3-Year Warranty)



Shown in Colburn style
Shown with Deluxe Lift Mechanism option
(3-Year Warranty)



b

Wall Beds are available in Aspen, Classic, Colburn, East Village, Justine, Loft, Prairie Mission, and Sheffield styles. Ships in 5 pieces. Assembly required.

a Wall Bed

Queen 65" w x 89½" h x 24" d Y01C

Features LED Light System, Exposed finished ends (including trim as needed - both top & bottom) and a 3-Year Warranty on mechanism.

Deluxe Lift accept up to 10" thick mattress.

Regular Lift accept up to 8" thick mattress.

b Sheffield Wall Bed

Queen 67½" w x 88½" h x 18" d WMSHE-Y01C

Features Regular Lift (accepts up to 8" thick mattress).
3-Year Warranty on mechanism.

MISC. BEDROOM

SLEEP



SHOWN IN CHERRY, GOLD DUST



a



b

a Aspen Jewelry Armoire with Inlay

26 $\frac{1}{4}$ "w x 18"d x 50"h MSAJA

Features black nylon velvet interior.

b Classic Jewelry Armoire

19 $\frac{1}{2}$ "w x 14 $\frac{3}{4}$ "d x 49"h MSCJA

Features flip-top mirror and black nylon velvet interior.

Sides open for necklace storage.



a



b



c



d



e



f

a East Village Jewelry Armoire

22" w x 16" d x 50" h MSEVJA

Features flip-top mirror and black nylon velvet interior. Sides open for necklace storage.

b Homestead Jewelry Armoire

19½" w x 14¾" d x 49" h MSHJA

Features flip-top mirror and black nylon velvet interior. Sides open for necklace storage.

c Justine Jewelry Armoire

20" w x 16" d x 50" h MSJUJA

Features flip-top mirror and black nylon velvet interior. Sides open for necklace storage.

d Loft Jewelry Armoire

22" w x 14¾" d x 48¾" h MSLJA

Features flip-top mirror and black nylon velvet interior in the upper drawers and doors. Sides open for necklace storage.

e McCoy Jewelry Armoire

24¾" w x 15½" d x 50¾" h MSMCJA

Features flip-top mirror and black nylon velvet interior in top drawers/doors. Sides open for necklace storage.

f Prairie Mission Jewelry Armoire

19½" w x 14¾" d x 49" h MSPMJA

Features flip-top mirror and black nylon velvet interior in top drawers and doors. Sides open for necklace storage.



EXPRESS



QUICKSHIP

simplyamish



a



b



c



d





e





f

a Aspen Santa Fe Bench with Inlay
62½" w x 19" d x 27¼" h DCSFAS60-
18" seat height.

b Aspen 2-Drawer Santa Fe Bench with Inlay
62" w x 19" d x 28" h SCASP-01C2 
18" seat height.

c Colburn Santa Fe Bench
64" w x 22" d x 28" h SCCBN-02C2 
18" seat height.

d Colburn 2-Drawer Santa Fe Bench
64" w x 23" d x 28" h SCCBN-01C2 
18" seat height.

e Justine Santa Fe Bench
60" w x 19" d x 28" h DCSFJS60-
18" seat height.

f Justine 2-Drawer Santa Fe Bench
59½" w x 19" d x 28" h SCJUS-01C2 
18" seat height.

 Available with fabric cushion seat or leather cushion seat. If using your own fabric please supply 2 yards. COM=Grade 3.



a



b



c



d



e



f

a Loft Santa Fe Bench

62½" w x 24" d x 29" h

DCSFL60-🍃

18" seat height.

b Loft 2-Drawer Santa Fe Bench

62" w x 24" d x 28" h

SCLFT-01C2 🍃

18" seat height.

c Louis Philippe Santa Fe Bench

64" w x 22" d x 28" h

DCSFLP60-🍃

18" seat height.

d Louis Philippe 2-Drawer Santa Fe Bench

62" w x 24" d x 28" h

SCLPP-01C2 🍃

18" seat height.

e McCoy Santa Fe Bench

63" w x 19" d x 28" h

DCSFMCC60 🍃

18" seat height.

f McCoy 2-Drawer Santa Fe Bench

63" w x 22" d x 28" h

SCMCC-01C2 🍃

18" seat height.

🍃 Available with fabric cushion seat or leather cushion seat. If using your own fabric please supply 2 yards. COM=Grade 3.



a



b



c



d





e



f

a Prairie Mission Lounge Bench

41" w x 17½" d x 18" h LFPMLB36-
 53" w x 17½" d x 18" h LFPMLB48-
 18" seat height.

c Ryan Santa Fe Bench

60¼" w x 24¾" d x 29" h DCSFRY60-
 18" seat height.

b Prairie Mission 2-Drawer Paneled Slat Santa Fe Bench

64½" w x 20½" d x 28" h SCPMS-01C2 
 18" seat height

d Ryan 2-Drawer Santa Fe Bench

60¼" w x 25" d x 29" h SCRYN-01C2 
 18" seat height.

e Royal Mission Santa Fe Bench with Walnut Inlay

62" w x 20½" d x 27" h DCSFRM60 
 18" seat height.

f Royal Mission 2-Drawer Santa Fe Bench with Walnut Inlay

62" w x 20½" d x 28" h SCRMS-01C2 
 18" seat height.

 Available with fabric cushion seat or leather cushion seat. If using your own fabric please supply 2 yards. COM=Grade 3.



a



b



c



d



e



f

a Raised Panel Storage Bench

44" w x 20" d x 22" h SBWR-W

Features large storage area under seat.
Not available in walnut.**b 2-Step Stool**

20" w x 19½" d x 13½" h SV2SSS

c Leaning Floor Mirror

38" w x 1¼" d x 72½" h MEAFM

Features a beveled mirror.

d Aspen Clothes Hamper with Inlay

25" w x 16" d x 31" h ECA240CH

e Clothes Hamper

20" w x 13" d x 26" h HS110CH

f Prairie Mission Clothes Hamper

24" w x 16" d x 31" h EC240CH

Available with fabric cushion seat or leather cushion seat. If using your own fabric please supply 2 yards. COM=Grade 3.



EXPRESS



QUICKSHIP

simplyamish



a



b



c



d

a Arch Top Wall Mirror
23 $\frac{3}{4}$ "w x 55 $\frac{1}{2}$ "h KADMATB
Features a beveled edge mirror.

b Arch Top Cheval Mirror
27"w x 23 $\frac{1}{2}$ "d x 66"h KACMAT
Features a beveled edge mirror.

c Aspen Cheval Mirror with Inlay
27 $\frac{3}{4}$ "w x 24"d x 65"h KACMECAB
Features a beveled edge mirror.

d Aspen Jewelry Cheval Mirror with Inlay
25"w x 24"d x 65"h TVASPJCM
Features a beveled edge mirror.



a



b



c



d

a Breckenridge Cheval Mirror
 27" w x 23½" d x 70¾" h KACMMB
 Features a beveled edge mirror.

b East Village II Cheval Mirror
 24½" w x 24" d x 69" h KACMEV
 Features a beveled edge mirror.

c Justine Jewelry Cheval Mirror
 25" w x 24" d x 65" h TVJUSJCM
 Features a beveled edge mirror.

d Loft Jewelry Cheval Mirror
 25" w x 24" d x 65" h TVLOFJCM
 Features a beveled edge mirror.



a



b



c



d

a MäRyan Jewelry Cheval Mirror

25" w x 24" d x 67³/₄" h TVMARJCM

Features a beveled edge mirror.

b McCoy Cheval Mirror

24¹/₂" w x 24" d x 63³/₄" h KACMMCB

Features a beveled edge mirror.

c McCoy Jewelry Cheval Mirror

25" w x 24" d x 65" h TVMCCJCM

Features a beveled edge mirror.

d Oval Cheval Mirror

28" w x 23" d x 62¹/₂" h BV059CM

Features a beveled edge mirror.



a



b



c



d

a Prairie Mission Wall Mirror27 $\frac{3}{4}$ "w x 59 $\frac{1}{2}$ "h

KADMPMB

Features a beveled edge mirror.

b Prairie Mission Cheval Mirror27 $\frac{3}{4}$ "w x 23 $\frac{1}{2}$ "d x 70 $\frac{3}{4}$ "h

KACMPMB

Features a beveled edge mirror.

c Shaker Jewelry Cheval Mirror

25"w x 24"d x 65"h

TVSHAJCM

Features a beveled edge mirror.

d Rectangle Cheval Mirror27"w x 23 $\frac{1}{2}$ "d x 62 $\frac{1}{2}$ "h

LFMCMB

Features a beveled edge mirror.

BEDS

STYLE YOUR OWN



2-PANEL HEADBOARD, SOLID PANEL, TOP WITH TRIM, TAPERED LEGS, SHOWN IN SOFT MAPLE, RAWHIDE

STEP 1 | CHOOSE HEADBOARD

8" Taller Option available on all headboards.

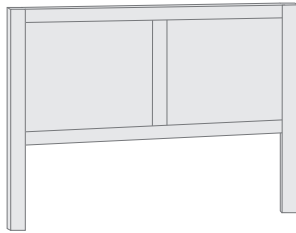

2-Panel Headboard with Wood Frame

Headboard: 47" h

CA King	76½" w x 87½" d	SB21W1
King	80½" w x 83½" d	SB21W2
Queen	64½" w x 83½" d	SB21W3
Full	58½" w x 79½" d	SB21W4
Twin	43½" w x 79½" d	SB21W5

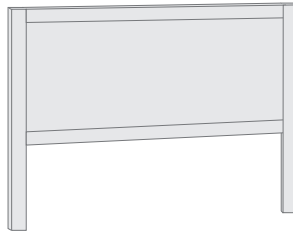

Single Panel Headboard with Wood Frame

Headboard: 47" h

CA King	76½" w x 87½" d	SB22W1
King	80½" w x 83½" d	SB22W2
Queen	64½" w x 83½" d	SB22W3
Full	58½" w x 79½" d	SB22W4
Twin	43½" w x 79½" d	SB22W5

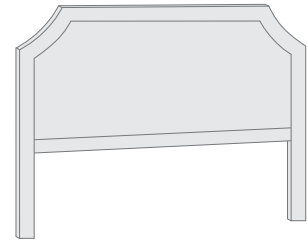

Curved Panel Headboard with Wood Frame

Headboard: 48" h

CA King	76½" w x 87½" d	SB27W1
King	80½" w x 83½" d	SB27W2
Queen	64½" w x 83½" d	SB27W3
Full	58½" w x 79½" d	SB27W4
Twin	43½" w x 79½" d	SB27W5

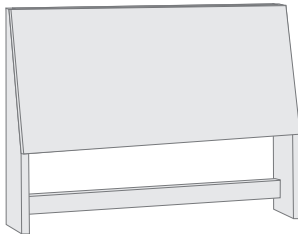

Angled-Back Headboard with Wood Frame

Headboard: 47" h

CA King	76½" w x 91" d	SBANG-29W1
King	80½" w x 87" d	SBANG-29W2
Queen	64½" w x 87" d	SBANG-29W3
Full	58½" w x 83" d	SBANG-29W4
Twin	43½" w x 83" d	SBANG-29W5

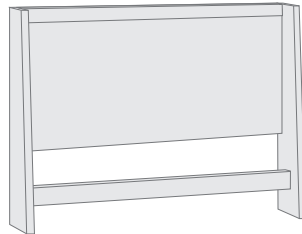

Modern Sleigh Single Panel Headboard with Wood Frame

Headboard: 47" h

CA King	76½" w x 88½" d	SBMOD-22W1
King	80½" w x 84½" d	SBMOD-22W2
Queen	64½" w x 84½" d	SBMOD-22W3
Full	58½" w x 80½" d	SBMOD-22W4
Twin	43½" w x 80½" d	SBMOD-22W5

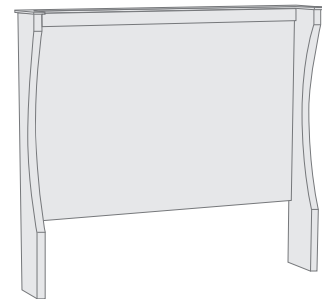

Shelter Single Panel Headboard with Wood Frame

Headboard: 56" h

CA King	76½" w x 88½" d	SBSH-22W1
King	80½" w x 84½" d	SBSH-22W2
Queen	64½" w x 84½" d	SBSH-22W3
Full	58½" w x 80½" d	SBSH-22W4
Twin	43½" w x 80½" d	SBSH-22W5

No top options available.

STEP 2 CHOOSE PANEL STYLE



Solid Panel
SBP-PL



Planked Panel
SBP-PK

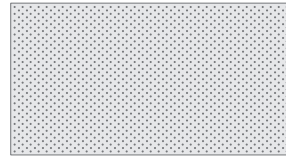

Upholstered Panel
SBP-U*
SBC-U* (for Curved Panel Headboard)



Slatted Panel
SBP-SL
(Only Available on Angled-Back Headboards)

STEP 3 CHOOSE TOP

Tops are only available on the Single Panel and 2-Panel Headboards (SB22W* & SB21W*)



Top with Trim
SBT-CH
Adds 1" to overall height.
Adds 2" to overall width.



Top with Large Bevel
SBT-LB
Adds 1" to overall height.
Adds 1½" to overall width.



Top with 1/8" Overhang
SBT-MO
Adds 1" to overall height.
Adds ¼" to overall width.



Top with 3/4" Overhang
SBT-TR
Adds 1" to overall height.
Adds 1½" to overall width.



Top with Reverse Bevel
SBT-RB
Adds 1" to overall height.
Adds 2" to overall width.

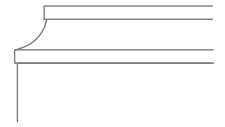

Cove Top
SBT-CT
Adds 2½" to overall height.
Adds ¼" to overall width.

STEP 4 CHOOSE FOOTBOARD LEGS

7" Taller Option available on all footboards.

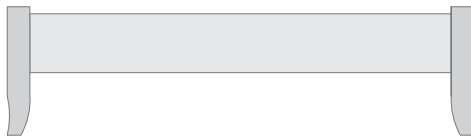

Curved Legs
Footboard: 13½" h
SBF-CH

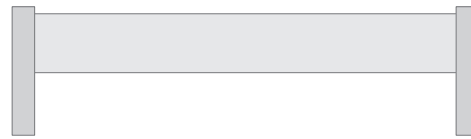

Square Legs
Footboard: 13½" h
SBF-MO

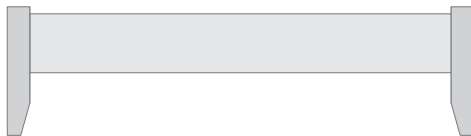

Tapered Legs
Footboard: 13½" h
SBF-TR

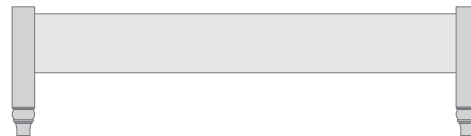

Turned Legs
Footboard: 13½" h
SBF-TU

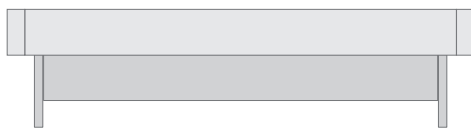

T-Base Footboard
Footboard: 13" h
SBFUL-TB

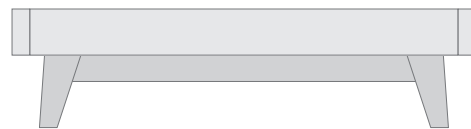

Angled Leg Footboard
Footboard: 13" h
SBFUL-AN

INSET NIGHTSTANDS

STYLE YOUR OWN



INSET NIGHTSTAND WITH OPENING, EXTRA WIDE, TOP WITH 1/8" OVERHANG, FLAT SLAB DRAWER, 4" SQUARE LEG, SHOWN IN CHERRY, HAZELNUT

STEP 1 | CHOOSE CASE

*Size does not include top and feet.



2-Drawer Inset Nightstand
23"w x 18"d x 20¼"h*
SN02B1



3-Drawer Inset Nightstand
23"w x 18"d x 24"h*
SN02C1

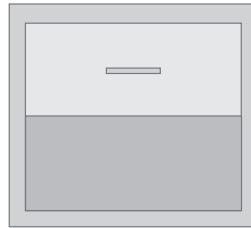

1-Drawer Inset Nightstand
23"w x 18"d x 20¼"h*
SN11A1

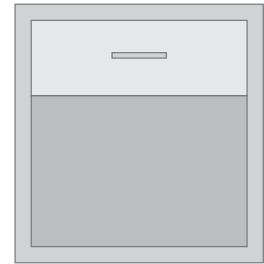

Inset Nightstand with Opening
23"w x 18"d x 24"h*
SN08A1



2-Drawer Inset Nightstand, Extra Wide
29"w x 18"d x 20¼"h*
SN02B4

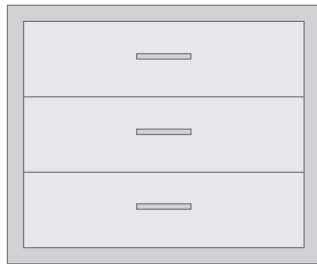

3-Drawer Inset Nightstand, Extra Wide
29"w x 18"d x 24"h*
SN02C4

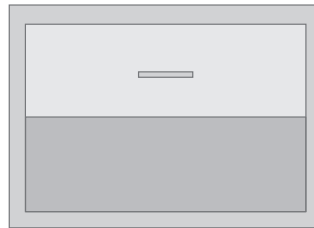

1-Drawer Inset Nightstand, Extra Wide
29"w x 18"d x 20¼"h*
SN11A4

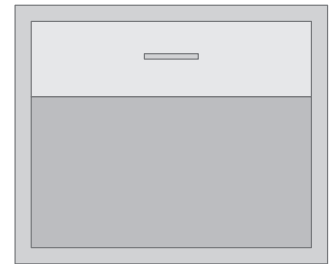

Inset Nightstand with Opening, Extra Wide
29"w x 18"d x 24"h*
SN08A4

STEP 2 CHOOSE TOP



Top with Trim

SNT-CH
Adds 3/4" to overall height.
Adds 2" to overall width.
Adds 1" to overall depth.

Top with Large Bevel

SNT-LB
Adds 3/4" to overall height.
Adds 1 1/2" to overall width.
Adds 3/4" to overall depth.

Top with 1/8" Overhang

SNT-MO
Adds 3/4" to overall height.
Adds 1/4" to overall width.
Adds 1/8" to overall depth.

Top with 3/4" Overhang

SNT-TR
Adds 3/4" to overall height.
Adds 1 1/2" to overall width.
Adds 3/4" to overall depth.

Top with Reverse Bevel

SNT-RB
Adds 3/4" to overall height.
Adds 2" to overall width.
Adds 1" to overall depth.

Cove Top

SNT-CT
Adds 2 1/2" to overall height.
Adds 1/4" to overall width.
Adds 1/8" to overall depth.

STEP 3 CHOOSE INSET DRAWER FRONT

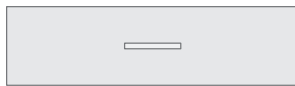

Flat Slab
SND-FS

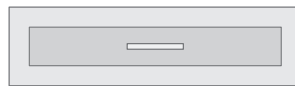

Flat Panel
SND-FP

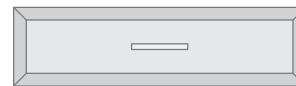

Raised Panel
SND-RP



Applied Trim
SND-RT

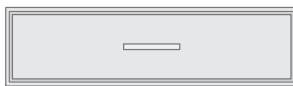

Beaded Edge
SND-BE

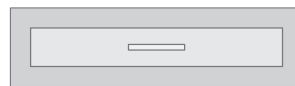

Step Panel
SND-SP

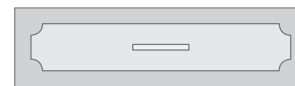

Scalloped Panel
SND-SC

STEP 4 CHOOSE LEG



4" Curved Leg
SNL-CH-4
Adds 4" to overall height.

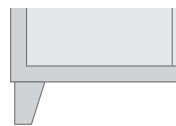

4" Tapered Leg
SNL-TR-4
Adds 4" to overall height.

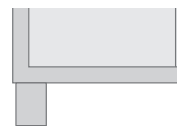

4" Square Leg
SNL-MO-4
Adds 4" to overall height.

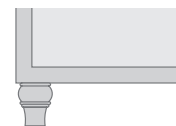

4" Turned Leg
SNL-TU-4
Adds 4" to overall height.



4" Plinth Base
SNL-PL-4
Adds 4" to overall height.

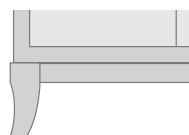

7" Curved Leg
SNL-CH-7
Adds 7" to overall height.

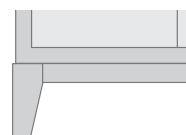

7" Tapered Leg
SNL-TR-7
Adds 7" to overall height.

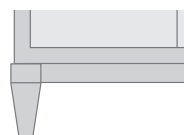

7" Round Tapered Leg
SNL-RD-7
Adds 7" to overall height.

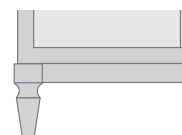

7" Beveled Leg
SNL-BV-7
Adds 7" to overall height.



7" Crossbar Base
SNL-CB-7
Adds 7" to overall height.

STEP 5 CHOOSE HARDWARE

Level A hardware is standard. See page 25 for complete selection.

INSET DRESSERS/CHESTS

STYLE YOUR OWN



6-DRAWER INSET DRESSER, TOP WITH TRIM, FLAT SLAB DRAWER, 4" CURVED LEG, SHOWN IN SOFT MAPLE, NIMBUS

STEP 1 | CHOOSE CASE

*Size does not include top and feet.



5-Drawer Inset Chest
31"w x 18"d x 45½"h* SS08E4



6-Drawer Inset Dresser
60½"w x 18"d x 28½"h* SS08F5



6-Drawer Inset Dresser, Extra Wide
70½"w x 18"d x 28½"h* SS08F3



8-Drawer Inset Dresser
60½"w x 18"d x 37"h* SS08H5



8-Drawer Inset Dresser, Extra Wide
70½"w x 18"d x 37"h* SS08H3



10-Drawer Inset Dresser
60½"w x 18"d x 45½"h* SS08K2

STEP 2 | CHOOSE TOP



Top with Trim
SST-CH
Adds ¾" to overall height.
Adds 2" to overall width.
Adds 1" to overall depth.



Top with Large Bevel
SST-LB
Adds ¾" to overall height.
Adds 1½" to overall width.
Adds ¾" to overall depth.



Top with 1/8" Overhang
SST-MO
Adds ¾" to overall height.
Adds ¼" to overall width.
Adds 1/8" to overall depth.



Top with ¾" Overhang
SST-TR
Adds ¾" to overall height.
Adds 1½" to overall width.
Adds ¾" to overall depth.



Top with Reverse Bevel
SST-RB
Adds ¾" to overall height.
Adds 2" to overall width.
Adds 1" to overall depth.

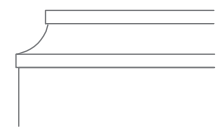

Cove Top
SST-CT
Adds 2½" to overall height.
Adds ¼" to overall width.
Adds 1/8" to overall depth.

STEP 3 CHOOSE INSET DRAWER FRONT



Flat Slab
SSD-FS



Flat Panel
SSD-FP



Raised Panel
SSD-RP



Applied Trim
SSD-RT

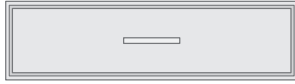

Beaded Edge
SSD-BE



Step Panel
SSD-SP

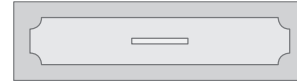

Scalloped Panel
SSD-SC

STEP 4 CHOOSE LEG/BASE

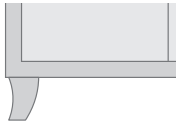

4" Curved Leg
SSL-CH-4
Adds 4" to overall height.

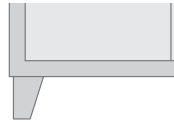

4" Tapered Leg
SSL-TR-4
Adds 4" to overall height.

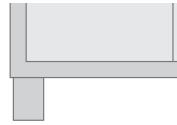

4" Square Leg
SSL-MO-4
Adds 4" to overall height.

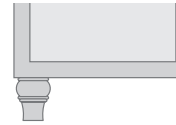

4" Turned Leg
SSL-TU-4
Adds 4" to overall height.



4" Plinth Base
SSL-PL-4
Adds 4" to overall height.

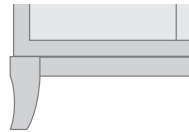

7" Curved Leg
SSL-CH-7
Adds 7" to overall height.

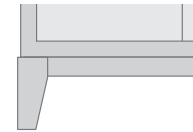

7" Tapered Leg
SSL-TR-7
Adds 7" to overall height.

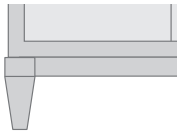

7" Round Tapered Leg
SSL-RD-7
Adds 7" to overall height.

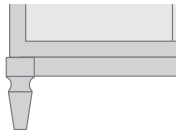

7" Beveled Leg
SSL-BV-7
Adds 7" to overall height.

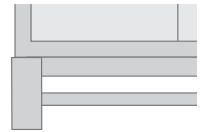

7" Crossbar Base
SSL-CB-7
Adds 7" to overall height.

STEP 5 CHOOSE HARDWARE

Level A hardware is standard. See page 25 for complete selection.

STEP 6 ADD A MIRROR

Tops optional.



SYO Dresser Mirror, 35 $\frac{1}{4}$ " x 36"
35 $\frac{1}{4}$ "w x 36"h SM06A2



SYO Dresser Mirror, 45 $\frac{1}{4}$ " x 36"
45 $\frac{1}{4}$ "w x 36"h SM06A3



SYO Dresser Mirror, 48 $\frac{3}{4}$ " x 26"
48 $\frac{3}{4}$ "w x 26"h SM01A2



SYO Dresser Mirror, 58 $\frac{3}{4}$ " x 26"
58 $\frac{3}{4}$ "w x 26"h SM01A3



Top with Trim
SMT-CH
Adds 1" to overall height.
Adds 2" to overall width.
Adds 1" to overall depth.

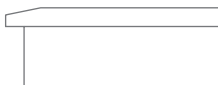

Top with Large Bevel
SMT-LB
Adds 1" to overall height.
Adds 1 $\frac{1}{2}$ " to overall width.
Adds $\frac{3}{4}$ " to overall depth.

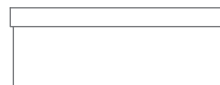

Top with $\frac{1}{8}$ " Overhang
SMT-MO
Adds 1" to overall height.
Adds $\frac{1}{4}$ " to overall width.
Adds $\frac{1}{8}$ " to overall depth.



Top with $\frac{3}{4}$ " Overhang
SMT-TR
Adds 1" to overall height.
Adds 1 $\frac{1}{2}$ " to overall width.
Adds $\frac{3}{4}$ " to overall depth.



Top with Reverse Bevel
SMT-RB
Adds 1" to overall height.
Adds 2" to overall width.
Adds 1" to overall depth.

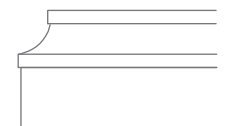

Cove Top
SMT-CT
Adds 2 $\frac{1}{2}$ " to overall height.
Adds $\frac{1}{4}$ " to overall width.
Adds $\frac{1}{8}$ " to overall depth.

FULL OVERLAY NIGHTSTANDS

STYLE YOUR OWN



2-DRAWER FULL OVERLAY NIGHTSTAND, TOP WITH REVERSE BEVEL, FLAT SLAB DRAWERS, ANGLED LEGS, SHOWN IN SOFT MAPLE, HAZELNUT

STEP 1 | CHOOSE CASE



- 2-Drawer Full Overlay Nightstand**
23" w x 18" d x 17¼" h*
SNFUL-02B1



- 3-Drawer Full Overlay Nightstand**
23" w x 18" d x 24" h*
SNFUL-02C1



- 2-Drawer Full Overlay Nightstand, Extra Wide**
29" w x 18" d x 17¼" h*
SNFUL-02B4

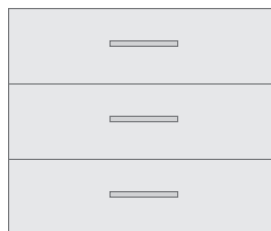

- 3-Drawer Full Overlay Nightstand, Extra Wide**
29" w x 18" d x 24" h*
SNFUL-02C4

*Size does not include top and feet.

STEP 2 CHOOSE TOP



Top with 1/8" Overhang
SNT-MO
Adds 3/4" to overall height.
Adds 1/4" to overall width.
Adds 1/8" to overall depth.



Top with 3/4" Overhang
SNT-TR
Adds 3/4" to overall height.
Adds 1 1/2" to overall width.
Adds 3/4" to overall depth.



Top with Reverse Bevel
SNT-RB
Adds 3/4" to overall height.
Adds 2" to overall width.
Adds 1" to overall depth.

STEP 3 CHOOSE FULL OVERLAY DRAWER FRONT

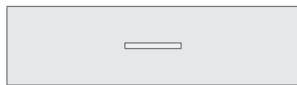

Flat Slab
SND-FS

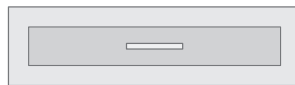

Flat Panel
SND-FP



Raised Panel
SND-RP



Applied Trim
SND-RT

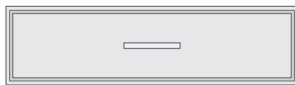

Beaded Edge
SND-BE

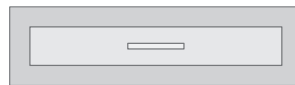

Step Panel
SND-SP

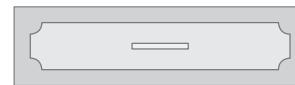

Scalloped Panel
SND-SC

STEP 4 CHOOSE LEG



Angled Leg
SNFUL-L-AN,
Adds 4" to overall height.



Cutout Base
SNFUL-L-CO,
Adds 4" to overall height.



T-Base
SNFUL-L-TB,
Adds 4" to overall height.

STEP 5 CHOOSE HARDWARE

Level A hardware is standard. See page 25 for complete selection.

FULL OVERLAY DRESSERS/CHESTS

STYLE YOUR OWN



6-DRAWER FULL OVERLAY DRESSER, TOP WITH REVERSE BEVEL, FLAT SLAB DRAWERS, ANGLED LEGS, SHOWN IN SOFT MAPLE, HAZELNUT

STEP 1 | CHOOSE CASE



5-Drawer Full Overlay Chest
31" w x 18" d x 45½" h*
SSFUL-04E0



6-Drawer Full Overlay Dresser
60½" w x 18" d x 28½" h* SSFUL-08F2



6-Drawer Full Overlay Dresser, Extra Wide
70½" w x 18" d x 28½" h* SSFUL-08F3



8-Drawer Full Overlay Dresser
60½" w x 18" d x 37" h* SSFUL-08H2



8-Drawer Full Overlay Dresser, Extra Wide
70½" w x 18" d x 37" h* SSFUL-08H3

STEP 2 | CHOOSE TOP



Top with 1/8" Overhang
SST-MO
Adds ¾" to overall height.
Adds ¼" to overall width.
Adds 1/8" to overall depth.



Top with ¾" Overhang
SST-TR
Adds ¾" to overall height.
Adds 1½" to overall width.
Adds ¾" to overall depth.

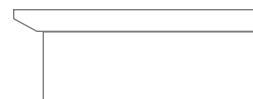

Top with Reverse Bevel
SST-RB
Adds ¾" to overall height.
Adds 2" to overall width.
Adds 1" to overall depth.

STEP 3 CHOOSE FULL OVERLAY DRAWER FRONT



Flat Slab
SSD-FS

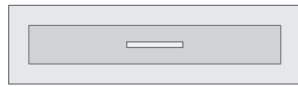

Flat Panel
SSD-FP

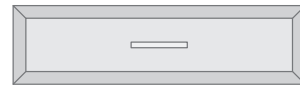

Raised Panel
SSD-RP



Applied Trim
SSD-RT



Beaded Edge
SSD-BE



Step Panel
SSD-SP



Scalloped Panel
SSD-SC

STEP 4 CHOOSE LEG

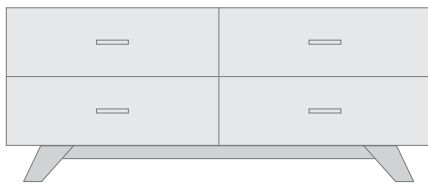

Angled Leg
SSFUL-L-AN, Adds 4" to overall height.

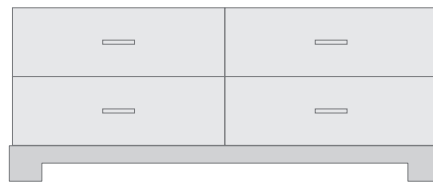

Cutout Base
SSFUL-L-CO, Adds 4" to overall height.

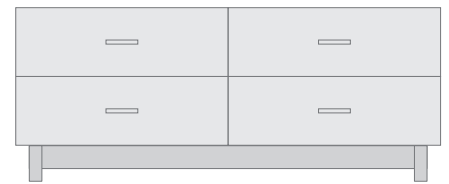

T-Base
SSFUL-L-TB, Adds 4" to overall height.

STEP 5 CHOOSE HARDWARE

Level A hardware is standard. See page 25 for complete selection.

STEP 6 ADD A MIRROR

Tops optional.



SYO Dresser Mirror, 35 $\frac{1}{4}$ " x 36"
35 $\frac{3}{4}$ "w x 36"h SM06A2



SYO Dresser Mirror, 45 $\frac{1}{4}$ " x 36"
45 $\frac{3}{4}$ "w x 36"h SM06A3



SYO Dresser Mirror, 48 $\frac{3}{4}$ " x 26"
48 $\frac{3}{4}$ "w x 26"h SM01A2



SYO Dresser Mirror, 58 $\frac{3}{4}$ " x 26"
58 $\frac{3}{4}$ "w x 26"h SM01A3



Top with $\frac{1}{8}$ " Overhang
SMT-MO
Adds 1" to overall height.
Adds $\frac{1}{4}$ " to overall width.
Adds $\frac{1}{8}$ " to overall depth.



Top with $\frac{3}{4}$ " Overhang
SMT-TR
Adds 1" to overall height.
Adds $1\frac{1}{2}$ " to overall width.
Adds $\frac{3}{4}$ " to overall depth.



Top with Reverse Bevel
SMT-RB
Adds 1" to overall height.
Adds 2" to overall width.
Adds 1" to overall depth.

ASPEN

EAT



This style comes standard with Flat Black Knobs (WK-A-05).

Michael's

SHOWN IN CHERRY, MICHAEL'S



a



b

Space Between Legs: 72" & 80" Table—45"; 96" Table—67"

a Aspen Leg Table with Inlay

Sizes below are available with two or four 12" leaves, 24" stationary butterfly leaf, and solid top. Tables with four leaves will get a center leg.

13/16" thick top – standard.

38" w x 48" l	MSALT3848-☞ (max 2)*	48" w x 60" l	MSALT4860-☞
38" w x 72" l	MSALT3872-☞	48" w x 72" l	MSALT4872-☞
38" w x 84" l	MSALT3884-☞	48" w x 84" l	MSALT4884-☞
40" w x 60" l	MSALT4060-☞	48" w x 48" l	MSALT4848-☞ (max 2)
42" w x 60" l	MSALT4260-☞	54" w x 54" l	MSALT5454-☞ (max 2)
42" w x 72" l	MSALT4272-☞		
42" w x 84" l	MSALT4284-☞		

b Aspen Trestle Table with Inlay

Sizes below are available with four 12" leaves, 32" stationary butterfly leaf, and solid top.

1" thick top – standard.

42" w x 72" l	MSA4272-☞*
42" w x 80" l	MSA4280-☞*
42" w x 96" l	MSA4296-☞*
48" w x 72" l	MSA4872-☞
48" w x 80" l	MSA4880-☞
48" w x 96" l	MSA4896-☞

☞ Specify the number of leaves, butterfly leaf or solid top. *Not available with butterfly leaf.

Some manufacturers use paint to simulate the look of inlaid wood. At Simply Amish our durable inlays are cut from strips of quality wood. These pieces are then glued into place, sanded flush with the surface and stained with the rest of the piece.



SATE-60
Large Bevel

Default Table Edge Profile for all tables in this collection.



Shown with leaf a



b



c



d



e

a Aspen Island Table with Inlay

54" w x 36" d x 36" h MSIA54
(54" x 54" with leaf)

1" thick top – standard.

Door area: 29" w x 20½" d x 11½" h;
Base: 35" w x 22" d

Features 18" stationary butterfly leaf,
ball-bearing slides, and leaf locks.

Open space behind doors.

b Aspen 3-Door Dining Cabinet with Glass Doors and Inlay * 🍷

57" w x 20" d x 52" h ECADC3BG

Features beveled glass doors, 2-LED light system, four drawers, and one adjustable glass shelf with plate groove.

Aspen 3-Door Dining Cabinet with Wood Doors and Inlay (not shown)

57" w x 20" d x 52" h ECADC3W

Features four drawers and one adjustable wood shelf.

c Aspen 2-Door Dining Cabinet with Glass Doors and Inlay * 🍷

40½" w x 20" d x 52" h ECADC2G

Features beveled glass doors, 2-LED light system, two drawers, and one adjustable glass shelf with plate groove.

Aspen 2-Door Dining Cabinet with Wood Doors and Inlay (not shown)

40½" w x 20" d x 52" h ECADC2W

Features two drawers and one adjustable wood shelf.

d Aspen Open Sideboard with Inlay

54" w x 18" d x 38" h ECASBD
Features open space behind doors.

e Aspen Open Sideboard with Wine Rack and Inlay

54" w x 18" d x 38" h ECASBW
Features open space behind doors.

🍷 Available with Beveled, Plain, Frosted, Water, or Antique Glass.



a



b



c



d



e



f

a Aspen 2-Door Cabinet with Inlay

36" w x 16" d x 32" h ESASP-J20E

b Aspen Closed Hutch with Inlay, Medium

Top: 45½" w x 17" d x 45¾" h ESASP-J06
 19" Base: 45½" w x 18¾" d x 35" h ESASP-A02B
 22" Base: 45½" w x 21¾" d x 35" h ESASP-C02B

Features two adjustable glass shelves with plate grooves in top and one adjustable shelf in base.

c Aspen Closed Hutch with Inlay, Large

Top: 64½" w x 17" d x 45¾" h ESASP-K06
 19" Base: 64½" w x 19" d x 35" h ESASP-A03E
 22" Base: 64½" w x 22" d x 35" h ESASP-C03E

Features two adjustable glass shelves with plate grooves in top and one adjustable shelf in base.

d Aspen Closed Hutch with Inlay, Extra Large

Top: 84½" w x 17" d x 45¾" h ESASP-L06
 19" Base: 84½" w x 19" d x 35" h ESASP-A04B
 22" Base: 84½" w x 22" d x 35" h ESASP-C04B

Features two adjustable glass shelves with plate grooves in top and one adjustable shelf in base.

e Aspen Open Hutch with Inlay, Large

Top: 64½" w x 17" d x 45¾" h ESASP-K07
 19" Base: 64½" w x 19" d x 35" h ESASP-A03E
 22" Base: 64½" w x 22" d x 35" h ESASP-C03E

Features one adjustable glass shelf with plate groove in top and one adjustable shelf in base.























f Aspen Closed Corner Hutch with Inlay, Medium

Top: 38" (each side) x 46" h ESASP-S02
 Base: 37" (each side) x 35" h ESASP-B02A

Features two adjustable glass shelves with plate grooves in top, a center drawer, two faux drawer fronts and one adjustable shelf in base.

Available with Beveled, Plain, Frosted, Water, or Antique Glass.



- a Aspen Chair with Inlay**  
 Arm chair Arm Height: 26" h
 25¾" w x 21¼" d x 48½" h SAAA - 
- b Aspen Chair with Lower Back and Inlay**  
 Arm chair Arm Height: 25¾" h
 25¾" w x 21¼" d x 43½" h SAAA-5 - 
- c Aspen Stationary Barstool with Inlay** 
 18½" w x 21" d (Seat Back: 18½" h)
 24" Seat Height SAABS24- 
 30" Seat Height SAABS30- 
- d Aspen Swivel Barstool with Inlay**  
 18" w (Seat Back: 21" h)
 24" Seat Height SAA24SBS- 
 30" Seat Height SAA30SBS- 
- e Aspen Dining Bench with Inlay** 
 36" w x 17" d x 18" h ECASP-12A- 
 48" w x 17" d x 18" h ECASP-12B- 
 60" w x 17" d x 18" h ECASP-12C- 
 72" w x 17" d x 18" h ECASP-12D- 
 80" w x 17" d x 18" h ECASP-12E- 
- f Aspen Swivel Barstool with Inlay, No Back**  
 16" w x 16" d
 18" Seat Height ECASP-06D-W
 24" Seat Height ECASP-06C-W
 30" Seat Height ECASP-06B-W
- Aspen Bench with Inlay** 
 36" w x 14" d x 18" h ECA770-36B
 48" w x 14" d x 18" h ECA770-48B
 60" w x 14" d x 18" h ECA770-60B
 72" w x 14" d x 18" h ECA770-72B
- Features the same lumbar support as the taller Aspen Chair.

 Available with wood seat, fabric cushion seat or leather cushion seat. If using your own fabric please supply ½ yard for chairs. Bench yardage varies. COM = Grade 3.

AUBURN BAY

EAT



SHOWN IN SOFT MAPLE, RAWHIDE



This style comes standard with Brushed Satin Nickel Pull (70-C-35).



a



b

Space Between Legs: 72" Table—42"; 84" Table—45"; 96" Table—67"

a Auburn Bay Trestle Table

2½" Edge Profile.

38" w x 72" l ETABR-H01D39A
 38" w x 84" l ETABR-H01D45A
 38" w x 96" l ETABR-H01D46A
 42" w x 72" l ETABR-H01D16A
 42" w x 84" l ETABR-H01D17A 
 42" w x 96" l ETABR-H01D18A
 48" w x 72" l ETABR-H01D26A
 48" w x 84" l ETABR-H01D29A
 48" w x 96" l ETABR-H01D30A

b Auburn Bay Bench

2" Edge Profile.

60" w x 16" d x 18" h
 72" w x 16" d x 18" h
 84" w x 16" d x 18" h
 96" w x 16" d x 18" h

ECABR-12C-W
 ECABR-12D-W 
 ECABR-12F-W
 ECABR-12G-W



a



b



c

a Auburn Bay Buffet

60" w x 18 3/4" d x 36" h ESABR-G16C
 72" w x 18 3/4" d x 36" h ESABR-G16D

Features one shelf on each side.

b Auburn Bay Credenza

60" w x 16" d x 36" h ESABR-H23C
 72" w x 16" d x 36" h ESABR-H23D

Features two shelves on each side.

c Claire Side Chair

19" w x 26" d x 39" h ECCLR-02A

Skirt option available. Nailhead options available.
 Features Sinuous Springs.

Available with fabric or leather. If using your own fabric please supply 2 1/2 yards. COM = Grade 3.

B&O RAILROAD®

EAT



SHOWN IN CHARACTER CHERRY, TOBACCO WITH OLDE WORLD AGING



This style comes standard with Flat Black Pull (66-I-02).



Available with hidden butterfly leaf on each end.

Space Between Legs: 72" & 80" Table—45"; 96" Table—67"

a B&O Railroad® Trestle Bridge Trestle Table

Sizes below are available with 18" butterfly leaf on each end, or solid top.

1" thick plank top - standard.

- 42" w x 72" l ETRB-H14D16-
- 42" w x 80" l ETRB-H14D44-
- 42" w x 96" l ETRB-H14D18-
- 48" w x 72" l ETRB-H14D26-
- 48" w x 80" l ETRB-H14D28-
- 48" w x 96" l ETRB-H14D30-

Specify the number of leaves, butterfly leaf, or solid top.

B&O RAILROAD® COLLECTION

INSPIRED BY THE PIONEERING DAYS OF THE GREAT WESTERN EXPANSION THAT WAS POWERED BY THE RAILROADS OF THE TIME.



a B&O Railroad® Trestle Bridge Round Single Pedestal Table

Available with up to three 12" leaves, 18" sliding butterfly leaf, or solid top.

1" thick plank top - standard.

- 48" Round ETTRB-F06D22 🍷
- 54" Round ETTRB-F06D32 🍷
- 60" Round ETTRB-F06D34 🍷 (Max 2)
- 72" Round ETTRB-F06D36 🍷 (Max 2)

b B&O Railroad® Trestle Bridge Island Table

58" w x 40" l x 36" h ETTRB-014D310
(58" w x 58" l with leaf) Base: 35" w x 22" l

Features 18" stationary butterfly leaf, ball-bearing slides, leaf locks and a drawer.

1" thick plank top - standard.

c B&O Railroad® Trestle Bridge Sideboard ➡ ➡

60" w x 19" d x 36 1/2" h ESTRB-D11

Features open space behind doors, plank top, and plank sides.

d B&O Railroad® Trestle Bridge Buffet

64" w x 19" d x 40 1/4" h ESTRB-G27C

Features open space behind doors, plank top, plank sides, and 1 adjustable shelf on each side.

🍷 Specify the number of leaves, butterfly leaf or solid top.

ALL ABOARD! TRAIN LEAVING FOR STYLETOWN. A ROMANTIC NOSTALGIA HAS BEEN CAPTURED IN THE UNIQUE DESIGN ELEMENTS OF OUR B&O RAILROAD® COLLECTION, INSPIRED BY THE HISTORY OF THIS TRAILBLAZING RAILROAD.



a Available with Beveled, Plain, Frosted, Water, or Antique Glass.



b

c

a B&O Railroad® Trestle Bridge 3-Door Dining Cabinet ✱
62" w x 20" d x 54" h ESTRB-E14-
Features 2-LED light system, plain glass doors and adjustable glass shelf with plate groove, plank top, and plank sides.

b B&O Railroad® Trestle Bridge Closed Hutch Top
64" w x 16" d x 46" h ESTRB-K06 

c B&O Railroad® Trestle Bridge Hutch Base
64" w x 19" d x 39½" h ESTRB-A03A
Features two adjustable shelves on each side.

 Available with Beveled, Plain, Frosted, Water, or Antique Glass.



a

b



c

d

a B&O Railroad® Trestle Bridge Chair

Arm Chair Arm Height: 25"

24" w x 24½" d x 42" h ECTRB-01A

Side Chair

21½" w x 24½" d x 42" h ECTRB-02A

b B&O Railroad® Trestle Bridge Stationary Barstool

22" w x 23½" d; Back 20½" h

24" Seat Height ECTRB-04C

30" Seat Height ECTRB-04B

c B&O Railroad® Trestle Bridge Backless Stationary Barstool

18" w x 14" d

18" Seat Height ECTRB-08D

24" Seat Height ECTRB-08C

30" Seat Height ECTRB-08B

d B&O Railroad® Trestle Bridge Dining Bench

36" w x 17" d x 18" h ECTRB-12A

48" w x 17" d x 18" h ECTRB-12B

60" w x 17" d x 18" h ECTRB-12C

72" w x 17" d x 18" h ECTRB-12D

80" w x 17" d x 18" h ECTRB-12E

Features plank top.



Available with wood seat, fabric cushion seat or leather cushion seat. If using your own fabric please supply ½ yard/chair; bench yardage will vary. COM = Grade 3.



EXPRESS



QUICKSHIP

simplyamish

B&O RAILROAD®

199

CRAWFORD

EAT



Crawford

SHOWN IN SOFT MAPLE, RAWHIDE



This style comes standard with Nickel Pull (70-E-10).



a



b

a Crawford Double Pedestal Table

Available with one 18" butterfly leaf on each end or solid top.
1" thick top—standard.

38" w x 60" l	ETCRA-G01D37
42" w x 60" l	ETCRA-G01D14
42" w x 72" l	ETCRA-G01D16
42" w x 84" l	ETCRA-G01D17
42" w x 96" l	ETCRA-G01D18
48" w x 60" l	ETCRA-G01D24
48" w x 72" l	ETCRA-G01D26
48" w x 84" l	ETCRA-G01D29
48" w x 96" l	ETCRA-G01D30

b Crawford Single Pedestal Table

Available with up to three 12" leaves,
18" sliding butterfly leaf, or solid top.
1" thick top—standard.

42" round (Max 2 Leaves)*	ETCRA-F06D12
48" round (Max 3 Leaves)	ETCRA-F06D22
54" round (Max 3 Leaves)	ETCRA-F06D32
60" round (Max 2 Leaves)	ETCRA-F06D34

*Not available with butterfly leaf.

Specify the number of leaves, butterfly leaf or solid top.



a



b



c



d



f



e



g

a Crawford Buffet

60" w x 18" d x 36" h ESCRA-G16C
72" w x 18" d x 36" h ESCRA-G16D

Features one adjustable shelf on each side.

b Crawford Credenza

60" w x 15" d x 36" h ESCRA-H23C
72" w x 15" d x 36" h ESCRA-H23D

Features two adjustable shelves on each side.

c Crawford Buffet with Legs

60" w x 18" d x 36" h ESCRA-G28C
72" w x 18" d x 36" h ESCRA-G28D

Features one adjustable shelf on each side.

d Crawford Credenza with Legs

60" w x 15" d x 36" h ESCRA-H28C
72" w x 15" d x 36" h ESCRA-H28D

Features two adjustable shelves on each side.

e Crawford Side Chair

18" w x 21½" d x 38¼" h ECCRA-02A-🍃

f Claire Bench with Upholstery

48" w x 20" d x 20" h ECCLR-16B-🍃
54" w x 20" d x 20" h ECCLR-16H-🍃
60" w x 20" d x 20" h ECCLR-16C-🍃
72" w x 20" d x 20" h ECCLR-16D-🍃
84" w x 20" d x 20" h ECCLR-16F-🍃

g Claire Bench

48" w x 16" d x 18" h ECCLR-19B-🍃
54" w x 16" d x 18" h ECCLR-19H-🍃
60" w x 16" d x 18" h ECCLR-19C-🍃
72" w x 16" d x 18" h ECCLR-19D-🍃
84" w x 16" d x 18" h ECCLR-19F-🍃

🍃 Only available with fabric cushion seat. If using your own fabric, yardage varies for benches. COM = Grade 3.

🍃 Available with wood seat, fabric cushion seat or leather cushion seat. If using your own fabric please supply ½ yard for chairs; yardage varies for benches. COM = Grade 3.

GRANT

EAT



G. Kraft

SHOWN IN QUARTERSAWN WHITE OAK, MICHAEL'S



This style comes standard with Darkened Hammered Brass Pulls (65-D-01 & 65-D-02).



SATE-60
Large Bevel

Default Table Edge Profile.

a Space Between Legs: 72" & 80" Table—45"; 96" Table—67"

a Grant Trestle Table

Sizes below are available with four 12" leaves, 32" stationary butterfly leaf, and solid top.

1" thick top – standard.

- 42" w x 72" l ETGRT-H07F16-☞*
- 42" w x 80" l ETGRT-H07F44-☞*
- 42" w x 96" l ETGRT-H07F18-☞*
- 48" w x 72" l ETGRT-H07F26-☞
- 48" w x 80" l ETGRT-H07F28-☞
- 48" w x 96" l ETGRT-H07F30-☞

*Not available with butterfly leaf.

☞ Specify the number of leaves, butterfly leaf or solid top.



a



b



c



d



e

a Grant 4-Drawer Sideboard

60" w x 19" d x 46 1/4" h, Top: 40" h TSGSB

Features two shelves in each door area.

b Grant Chair ☒

Arm chair Arm Height: 25 1/2" h

24" w x 21" d x 42" h SAGRA-☒

Side chair

18" w x 20" d x 42" h SAGRS-☒

c Grant II Chair ☒

Arm chair Arm Height: 25 1/2" h

23" w x 20" d x 38" h SAGRIIA-4-☒

Side chair

17 3/4" w x 19 3/4" d x 38" h SAGRIIS-4-☒

d Grant Stationary Barstool

18 1/4" w x 20 1/2" d; Seat Back: 19" h

24" Seat Height SAGRSBS24-☒

30" Seat Height SAGRSBS30-☒

e Grant II Stationary Barstool

18" w x 19" d; Seat Back: 18" h

24" Seat Height SAGRIIBS24-☒

30" Seat Height SAGRIIBS30-☒

☒ Available with wood seat, fabric cushion seat, or leather cushion seat. If using your own fabric please supply 1/2 yard. COM = Grade 3.

HAMPTONS

EAT



This style comes standard with Ring Pull (80-B-13)

CMAA

SHOWN IN SOFT MAPLE, BARNBOARD



SATE-40
Small Roundover Edge

a

Space Between Legs: 72" & 84" Table—45"; 96" Table—67"

a Hamptons Trestle Table

Sizes below are available with an 18" stationary butterfly leaf on each end or solid top.

1" thick top – standard.

42" w x 66" l	ETHAP-H01D15	🍃
42" w x 72" l	ETHAP-H01D16	🍃
42" w x 84" l	ETHAP-H01D17	🍃
42" w x 96" l	ETHAP-H01D18	🍃
48" w x 66" l	ETHAP-H01D25	🍃
48" w x 72" l	ETHAP-H01D26	🍃
48" w x 84" l	ETHAP-H01D29	🍃
48" w x 96" l	ETHAP-H01D30	🍃

🍃 Specify butterfly leaf or solid top.



a



b



c



a Hamptons Buffet

Doors feature push to open hardware, frosted glass and a shelf behind each door.

60" w x 18" d x 36" h ESHAP-G27C
72" w x 18" d x 36" h ESHAP-G27D

b Hamptons Chair

Arm chair Arm Height: 25" h
24 3/4" w x 21 1/2" d x 40" h ECHAP-01A-🍃

Side chair
19" w x 22" d x 40" h ECHAP-02A-🍃

c Hamptons Trestle Dining Bench

48" w x 17" d x 18 3/4" h ECHAP-13B-W
60" w x 17" d x 18 3/4" h ECHAP-13C-W
72" w x 17" d x 18 3/4" h ECHAP-13D-W
84" w x 17" d x 18 3/4" h ECHAP-13F-W
96" w x 17" d x 18 3/4" h ECHAP-13G-W

🍃 Available with wood seat, fabric cushion seat or leather cushion seat. If using your own fabric please supply 1/2 yard. COM = Grade 3.

IRONWOOD

EAT



Features Push-To-Open Doors.

SHOWN IN SOFT MAPLE, BARNBOARD



Space Between Legs: 72" Table—42"; 84" Table—45"

a Ironwood Trestle Table

2½" Edge Profile.

Black Base:

38" w x 60" l,	Black Base	ETIRN-H01D37A-B
38" w x 72" l,	Black Base	ETIRN-H01D39A-B
38" w x 84" l,	Black Base	ETIRN-H01D45A-B
42" w x 60" l,	Black Base	ETIRN-H01D14A-B
42" w x 72" l,	Black Base	ETIRN-H01D16A-B
42" w x 84" l,	Black Base	ETIRN-H01D17A-B
48" w x 60" l,	Black Base	ETIRN-H01D24A-B
48" w x 72" l,	Black Base	ETIRN-H01D26A-B
48" w x 84" l,	Black Base	ETIRN-H01D29A-B

Gunmetal Base:

38" w x 60" l,	Gunmetal Base	ETIRN-H01D37A-C
38" w x 72" l,	Gunmetal Base	ETIRN-H01D39A-C
38" w x 84" l,	Gunmetal Base	ETIRN-H01D45A-C
42" w x 60" l,	Gunmetal Base	ETIRN-H01D14A-C
42" w x 72" l,	Gunmetal Base	ETIRN-H01D16A-C
42" w x 84" l,	Gunmetal Base	ETIRN-H01D17A-C
48" w x 60" l,	Gunmetal Base	ETIRN-H01D24A-C
48" w x 72" l,	Gunmetal Base	ETIRN-H01D26A-C
48" w x 84" l,	Gunmetal Base	ETIRN-H01D29A-C



a



b



c



d

a Ironwood Buffet

60" w x 20" d x 32" h, Black Base ESIRN-G27C-B
 72" w x 20" d x 32" h, Black Base ESIRN-G27D-B
 60" w x 20" d x 32" h, Gunmetal Base ESIRN-G27C-C
 72" w x 20" d x 32" h, Gunmetal Base ESIRN-G27D-C
 Features two adjustable shelves on each side;
 push-to-open doors.

b Ironwood Credenza

60" w x 18" d x 30" h, Black Base ESIRN-H27C-B
 72" w x 18" d x 30" h, Black Base ESIRN-H27D-B
 60" w x 18" d x 30" h, Gunmetal Base ESIRN-H27C-C
 72" w x 18" d x 30" h, Gunmetal Base ESIRN-H27D-C
 Features two adjustable shelves on each side;
 1 adjustable shelf in the center; push-to-open doors.

c Claire Side Chair ⇌ ⇨

19" w x 26" d x 39" h ECCLR-02A-
 Skirt option available. Nailhead options available.
 Features Sinuous Springs.

d Ironwood Bench

Wood seat and 2" Edge Profile.
 48" w x 16" d x 18" h, Black Base ECIRN-17B-W-B
 60" w x 16" d x 18" h, Black Base ECIRN-17C-W-B
 72" w x 16" d x 18" h, Black Base ECIRN-17D-W-B
 84" w x 16" d x 18" h, Black Base ECIRN-17F-W-B
 48" w x 16" d x 18" h, Gunmetal Base ECIRN-17B-W-C
 60" w x 16" d x 18" h, Gunmetal Base ECIRN-17C-W-C
 72" w x 16" d x 18" h, Gunmetal Base ECIRN-17D-W-C
 84" w x 16" d x 18" h, Gunmetal Base ECIRN-17F-W-C

 Available with fabric or leather. If using your own fabric please supply 2½ yard. COM = Grade 3.

JUSTINE

EAT



This style comes standard with Nickel Pulls (70-B-20).

SHOWN IN CHERRY, GOLD DUST



Space Between Legs: 72" & 80" Table—45"; 96" Table—67"

a Justine Leg Table

Sizes below are available with two or four 12" leaves, 24" stationary butterfly leaf, and solid top. Tables with four leaves will get a center leg.

13/16" thick top – standard.

- 38" w x 48" l MSJ3848-☞* (max 2)
- 38" w x 72" l MSJ3872-☞
- 38" w x 84" l MSJ3884-☞
- 40" w x 60" l MSJ4060-☞
- 42" w x 60" l MSJ4260-☞
- 42" w x 72" l MSJ4272-☞
- 42" w x 84" l MSJ4284-☞
- 48" w x 48" l MSJ4848-☞ (max 2)
- 48" w x 60" l MSJ4860-☞
- 48" w x 72" l MSJ4872-☞
- 48" w x 84" l MSJ4884-☞
- 54" w x 54" l MSJ5454-☞ (max 2)

b Justine Trestle Table

Sizes below are available with four 12" leaves, 32" stationary butterfly leaf, 18" butterfly leaf on each end, or solid top.

1" thick top – standard.

- 42" w x 72" l ETJUS-H01D16-☞
- 42" w x 80" l ETJUS-H01D44-☞
- 42" w x 96" l ETJUS-H01D18-☞
- 48" w x 72" l ETJUS-H01D26-☞
- 48" w x 80" l ETJUS-H01D28-☞
- 48" w x 96" l ETJUS-H01D30-☞

c Justine Island Table

54" w x 36" l x 36" h MSIJ54
(54" w x 54" l with leaf)

Base: 35" w x 22" l

Features 18" stationary butterfly leaf, ball-bearing slides, leaf locks and a drawer.
1" thick top – standard.

Justine Cross-Section

Default Table Edge Profile

☞ Specify the number of leaves, butterfly leaf or solid top. *Not available with butterfly leaf.



Memory Swivel Standard.

a Justine Open Sideboard
 51" w x 16" d x 37" h TVJSB
 Features open space behind doors.

b Justine 3-Door Dining Cabinet with Glass Doors and Ends ✨
 57" w x 18½" d x 51" h SCDCJS3G-
 Features plain glass doors, 2-LED light system, four drawers, and adjustable glass shelf with plate groove.

c Justine Closed Hutch, Large ✨
 Top:
 60¾" w x 15" d x 46½" h ESJUS-K02
 Base:
 60¾" w x 19" d x 34½" h ESJUS-A03E
 Features 3-LED light system, glass shelves with plate grooves in top and one adjustable shelf on each side of the base.

d Justine Chair
 Arm chair Arm Height: 25" h
 23" w x 22" d x 40" h KSJAC-
 Side chair
 18¾" w x 22" d x 40" h KSJSC-

e Justine Stationary Barstool
 18¾" w x 22" d Seat Back: 19" h
 24" Seat Height KSJBSS24-
 30" Seat Height KSJBSS30-

f Justine Swivel Barstool ⚙️
 Side stool 18¾" w x 21" d (Back 19" h)
 24" Seat Height KAJSBS-06C-
 30" Seat Height KAJSBS-06B-

g Justine Dining Bench
 36" w x 17" d x 17½" h ECJUS-12A-
 48" w x 17" d x 17½" h ECJUS-12B-
 60" w x 17" d x 17½" h ECJUS-12C-
 72" w x 17" d x 17½" h ECJUS-12D-
 80" w x 17" d x 17½" h ECJUS-12E-

✨ Available with Beveled, Plain, Frosted, Water, or Antique Glass.
 ⚙️ Available with wood seat, fabric cushion seat or leather cushion seat. If using your own fabric please supply ½ yard for chairs; yardage for benches varies. COM = Grade 3.

LIVE EDGE

EAT



SHOWN IN WALNUT, NATURAL



FIND YOUR OWN UNIQUE
LIVE EDGE TABLE TOP AT
SIMPLYAMISH.COM/LIVEEDGE/TOPS/



Every piece of Simply Amish LIVE EDGE furniture is unique, featuring the rugged, natural beauty of an individual tree. This distinctive furniture retains the beauty of the natural wood while offering a bold new look to fine furniture.

Just because LIVE EDGE is rough around the edges, doesn't mean it's not refined.

We offer many unique, hand-crafted selections, including made-to-order tables as well as a selection of ready-to-ship occasional tables and benches. Just go to the website and select a completed table, or create your own unique table by selecting a top and customizing it with your choice of base and finish.

We offer a selection of trestle and double pedestal bases to complement your custom LIVE EDGE top. You can even have the top shortened to your desired length.

WHAT IS LIVE EDGE? UNIQUE. RUGGED. BOLD. BEAUTIFUL.

LIVE EDGE furniture is hand-crafted to showcase nature's beauty, with each piece featuring the natural edge of the tree in its design. Think of LIVE EDGE as nature's art gallery. Gather people around your LIVE EDGE top and show them the heart wood, outer sap wood, a growth ring, or the cambium, which reveals the tree's health history.

LIVE EDGE by Simply Amish wooden tables are crafted to the same exacting standards we apply to the rest of our furniture. We remove most of the bark to stabilize the wood and sand the edges smooth.

All of the Northern Hardwood trees we utilize for our LIVE EDGE furniture are responsibly harvested, ensuring you the most beautiful, durable, and sturdy LIVE EDGE tables available.

Available in Cherry, Maple, and Walnut, some of our table tops are book matched, some are solid, while others have natural edges joined to a center slab cut from the same tree. No two LIVE EDGE tables are alike in appearance, and we number each top so you know you're getting exactly what you see.



LET'S NOT FORGET THE BASE.

These tops are a bit too heavy to hold with one hand and carve that Beef Wellington with the other. Simply Amish offers a wide range of trestle and double pedestal bases for our custom LIVE EDGE tops. After you select the perfect top, you will be able to customize your table by choosing the base, height, and finish that are just right for your home or office.

BEAUTIFULLY FINISHED AND PROTECTED.

Cherry and Walnut finish options are the same as for our regular furniture. If your LIVE EDGE table will be used for dining, our three coats of catalyzed varnish will protect your table top beautifully from spills.

The stain samples located in our design centers at your Simply Amish dealer render the most accurate depiction of color. Stain samples may also be viewed on the woods and stains page of our website. Please remember your computer monitor may not accurately reflect the actual color of the stain.

EVERY LIVE EDGE ITEM IS UNIQUE.

Once a piece is sold, it's gone. So, keep an eye on our website for our latest offerings of LIVE EDGE table tops, benches, and occasional tables. We're constantly expanding our LIVE EDGE selection, adding exciting new pieces.

SimplyAmish.com/LiveEdge/



LOFT EAT



R. Schrock

SHOWN IN CHERRY, BOURBON



This style comes standard with Nickel Pull (70-E-10).



SATE-60
Large Bevel Edge

a







SATE-60
Large Bevel Edge

b

a Grace Double Pedestal Table

Sizes below are available with two or four 12" wide leaves or solid top.





1" thick top – standard

- 38" w x 60" l ETGRC-G05F37- 
- 42" w x 60" l ETGRC-G05F14- 
- 42" w x 72" l ETGRC-G05F16- 
- 48" w x 60" l ETGRC-G05F24- 
- 48" w x 72" l ETGRC-G05F26- 

b Grace Single Pedestal Table

Sizes below are available with a selection of 12" leaves, 18" sliding butterfly leaf, or solid top. Aprons are not available on single pedestal tables with a butterfly leaf.

1" thick top – standard

- 38" Round ETGRC-F06F04- * (max 2)
- 42" Round ETGRC-F06F12- * (max 2)
- 48" Round ETGRC-F06F22-  (max 3)
- 54" Round ETGRC-F06F32-  (max 3)
- 60" Round ETGRC-F06F34-  (max 2)

 Specify the number of leaves, butterfly leaf or solid top. *Not available with butterfly leaf.



a



b



c

d

a Loft II Round Table

Sizes below are available with a selection of 12" leaves, 18" sliding butterfly leaf, or solid top. Aprons on the leaf are not available on single pedestal tables with a butterfly leaf.

1" thick top – standard

- 48" Round NBL4848- (max 3)
- 54" Round NBL5454- (max 3)
- 60" Round NBL6060- (max 2)

b Park Avenue Single Pedestal Table

Sizes below are available with a selection of 12" leaves, 18" sliding butterfly leaf, or solid top. Aprons are not available on single pedestal tables with a butterfly leaf.

1" thick top – standard

- 48" Round SASPA48- (max 3)
- 54" Round SASPA54- (max 3)
- 60" Round SASPA60- (max 2)

c Loft II Oval Table

Sizes below are available with two or four 12" leaves, or solid top.

1" thick top – standard

- 42" w x 60" l NBL04260-
- 42" w x 72" l NBL04272-
- 48" w x 60" l NBL04860-
- 48" w x 72" l NBL04872-

d Loft Island Table

1" thick top – standard

54" w x 36" l x 36" h MSIL54
(54" w x 54" l with leaf)

Base: 35" w x 22" l

Features 18" stationary butterfly leaf, ball-bearing slides, leaf locks and one adjustable shelf behind doors.

Specify the number of leaves, butterfly leaf or solid top. *Not available with butterfly leaf.



a



b



c



d

a Loft 3-Door Dining Cabinet with Glass Doors and Ends ✱

57½" w x 18½" d x 51" h SCDCLO3G-

Features plain glass doors, 2-LED light system, four drawers, and adjustable glass shelf with plate groove.

Loft 3-Door Dining Cabinet with Wood Doors and Ends (not shown)

57½" w x 18½" d x 51" h SCDCLO3W

Features one adjustable wood shelf.

b Loft 2-Door Dining Cabinet with Glass Doors and Ends ✱

40½" w x 18½" d x 51" h SCDCLO2G-

Features plain glass doors, 2-LED light system, two drawers, and adjustable glass shelf with plate groove.

Loft 2-Door Dining Cabinet with Wood Doors and Ends (not shown)

40½" w x 18½" d x 51" h SCDCLO2W

Features one adjustable wood shelf.

c Loft Open Hutch, Large

Top: 60" w x 15" d x 47¼" h ESLFT-K07

Base: 58" w x 18½" d x 34½" h ESLFT-A03A

Top features one adjustable glass shelf. Center panel comes as a fixed, non-working door. Base features one adjustable shelf behind doors.

d Loft II Sideboard

62" w x 19" d x 46¼" h TSLII60SB

Backsplash 6¼" h; Top: 40" h

Door area with two adjustable shelves on each side: 14" w x 17" d x 25¼" h

Available with Beveled, Plain, Frosted, Water, or Antique Glass.



a Loft Chair

Arm chair Arm Height: 25½”h
22½”w x 21”d x 42”h SALOA-4

Side chair
20½”w x 21”d x 42”h SALOS-4

Loft Chair with Shorter Back

Arm Chair (Not Shown) Arm Height: 25½”h
22½”w x 21”d x 38”h SALOA-4

Side chair (Not Shown)
20½”w x 21”d x 38”h SALOS-4

b Loft II Chair

Arm chair Arm Height: 26”h
24”w x 24”d x 42½”h CCLIIA-4

Side chair
21”w x 24”d x 42½”h CCLIIS-4

c Loft Stationary Barstool

19”w x 22”d (Back 18½”h)
24” Seat Height SALOBSS24-4
30” Seat Height SALOBSS30-4

d Loft II Stationary Barstool

18¾”w x 23½”d (Back 21”h)
24” Seat Height ECL02-04C-4
30” Seat Height ECL02-04B-4

e Loft II Swivel Barstool

Arm stool 24”w 23½”d; Arm: 8”h (Back 21”h)

24” Seat Height ECL02-05C-4
30” Seat Height ECL02-05B-4

Side stool 18¾”w 23½”d (Back 21”h)

24” Seat Height ECL02-06C-4
30” Seat Height ECL02-06B-4

f Loft Dining Trestle Bench

36”w x 17”d x 18”h ECLFT-13A-W
48”w x 17”d x 18”h ECLFT-13B-W
60”w x 17”d x 18”h ECLFT-13C-W
72”w x 17”d x 18”h ECLFT-13D-W
80”w x 17”d x 18”h ECLFT-13E-W

Loft Trestle Bench

36”w x 11”d x 17¾”h PLL36TB
48”w x 11”d x 17¾”h PLL48TB
60”w x 11”d x 17¾”h PLL60TB
72”w x 11”d x 17¾”h PLL72TB

Available with wood seat, fabric cushion seat or leather cushion seat. If using your own fabric please supply ½ yard per chair. COM = Grade 3.

MÄRYAN

EAT



This style comes standard with German Bronze Pulls (94-D-01).

SHOWN IN QUARTERSAWN WHITE OAK, BOURBON



a



b

Space Between Legs: 72" & 80" Table—45"; 96" Table—67"

a MäRyan Leg Table

Sizes below are available with two or four 12" leaves, 24" stationary butterfly leaf, or solid top. Tables with four leaves will get a center leg.

13/16" thick top - standard.

38" w x 48" l	ETMRY-J01H05-☞* (max 2)
38" w x 72" l	ETMRY-J01H39-☞*
38" w x 84" l	ETMRY-J01H45-☞*
40" w x 60" l	ETMRY-J01H07-☞*
42" w x 60" l	ETMRY-J01H14-☞
42" w x 72" l	ETMRY-J01H16-☞
42" w x 84" l	ETMRY-J01H17-☞
48" w x 48" l	ETMRY-J01H22-☞ (max 2)
48" w x 60" l	ETMRY-J01H24-☞
48" w x 72" l	ETMRY-J01H26-☞
48" w x 84" l	ETMRY-J01H29-☞
54" w x 54" l	ETMRY-J01H32-☞ (max 2)

b MäRyan Trestle Table

Sizes below are available with four 12" leaves, 32" stationary butterfly leaf, or solid top.

1" thick top - standard.

42" w x 72" l	ETMRY-H01H16-☞*
42" w x 80" l	ETMRY-H01H44-☞*
42" w x 96" l	ETMRY-H01H18-☞*
48" w x 72" l	ETMRY-H01H26-☞
48" w x 80" l	ETMRY-H01H28-☞
48" w x 96" l	ETMRY-H01H30-☞

*Not available with butterfly leaf.

☞ Specify the number of leaves, butterfly leaf or solid top.



a

SATE-40
Small Roundover Edge

Default Table Edge Profile for all tables in this collection.



b



c



d

Space Between Legs: 72" & 80" Table—45"; 96" Table—67"

a Franklin Trestle Table

Sizes below are available with four 12" leaves, 32" stationary butterfly leaf, 18" stationary butterfly leaf on each end, or solid top.

1" thick top - standard.

- 42" w x 72" l MSCT-TT4272-🍃
- 42" w x 80" l MSCT-TT4280-🍃
- 48" w x 72" l MSCT-TT4872-🍃
- 48" w x 80" l MSCT-TT4880-🍃

b MäKayla Trestle Table

Sizes below are available with four 12" wide leaves, 32" stationary butterfly leaf, or solid top.

1" thick top - standard.

- 42" w x 72" l ETMKY-H01H16-🍃*
- 42" w x 80" l ETMKY-H01H44-🍃*
- 42" w x 96" l ETMKY-H01H18-🍃*
- 48" w x 72" l ETMKY-H01H26-🍃
- 48" w x 80" l ETMKY-H01H28-🍃
- 48" w x 96" l ETMKY-H01H30-🍃

c Franklin Trestle II Table

Sizes below are available with two or four 12" leaves, 32" stationary butterfly leaf, 18" stationary butterfly leaf on each end or solid top.

1" thick top - standard.

- 36" w x 48" l ETRFK-I13H03-🍃 (max 2)*
- 38" w x 60" l ETRFK-I13H37-🍃*
- 38" w x 72" l ETRFK-I13H39-🍃*
- 42" w x 72" l ETRFK-I13H16-🍃
- 42" w x 84" l ETRFK-I13H17-🍃
- 42" w x 96" l ETRFK-I13H18-🍃
- 48" w x 72" l ETRFK-I13H26-🍃
- 48" w x 84" l ETRFK-I13H22-🍃
- 48" w x 96" l ETRFK-I13H30-🍃

d MäRyan Island Table

58" w x 40" l x 36" h ETMRY-001H310 (58" w x 58" l with leaf)
Base: 35" w x 22" l

Features 18" stationary butterfly leaf, ball-bearing slides, leaf locks and one adjustable shelf behind doors.

1" thick top - standard.

*Not available with butterfly leaf.

🍃 Specify the number of leaves, butterfly leaf or solid top.

Keeping your secrets safe.

The MäRyan Collection features secret drawers with felt-lined bottoms on all cabinets under 56" tall.



a MäRyan 3-Door Dining Cabinet *
 63½" w x 22" d x 55¼" h NWDCM3G-
 Features plain glass doors, 2-LED light system, four drawers and two secret drawers, and adjustable glass shelf with plate groove.

b MäRyan Sideboard
 71" w x 22" d x 40¾" h NWMRSB
 Features three secret drawers and two adjustable shelves behind doors.

c MäRyan Closed Hutch, Extra Large *
 Top: 81¼" w x 18" d x 48" h ESMRY-L06
 Base: 81¼" w x 25" d x 36" h ESMRY-C04A
 Features two adjustable glass shelves, 3-LED light system in top, three secret drawers in base, and one adjustable shelf behind doors in base.

Available with Beveled, Plain, Frosted, Water, or Antique Glass.



d



e



f



g

a Märyan Chair

Arm chair Arm Height: 25¾" h
24¼" w x 25½" d x 42½" h ECMRY-01A-🍷

Side chair
19½" w x 25½" d x 42½" h ECMRY-02A-🍷

b Märyan Stationary Barstool

19¾" w x 24" d Back: 23¾" h
24" Seat Height ECMRY-04C-🍷
30" Seat Height ECMRY-04B-🍷

c Franklin Chair

Arm Chair Arm Height: 25" h
25¼" w x 22½" d x 44½" h KAFCB-🍷

Side Chair
19" w x 22" d x 44½" h KAFCB-🍷

d MäKayla Dining Bench

36" w x 17" d x 18" h ECMRY-12A-🍷
48" w x 17" d x 18" h ECMRY-12B-🍷
60" w x 17" d x 18" h ECMRY-12C-🍷
72" w x 17" d x 18" h ECMRY-12D-🍷
80" w x 17" d x 18" h ECMRY-12E-🍷

e Franklin Dining Bench

36" w x 17" d x 18" h ECFRK-12A-🍷
48" w x 17" d x 18" h ECFRK-12B-🍷
60" w x 17" d x 18" h ECFRK-12C-🍷
72" w x 17" d x 18" h ECFRK-12D-🍷
80" w x 17" d x 18" h ECFRK-12E-🍷

f Franklin Dining Trestle Bench

36" w x 17" d x 17¾" h ECFRK-13A-W
48" w x 17" d x 17¾" h ECFRK-13B-W
60" w x 17" d x 17¾" h ECFRK-13C-W
72" w x 17" d x 17¾" h ECFRK-13D-W
80" w x 17" d x 17¾" h ECFRK-13E-W

g Franklin II Dining Trestle Bench

36" w x 17" d x 17¾" h ECFR2-13A-W
48" w x 17" d x 17¾" h ECFR2-13B-W
60" w x 17" d x 17¾" h ECFR2-13C-W
72" w x 17" d x 17¾" h ECFR2-13D-W
80" w x 17" d x 17¾" h ECFR2-13E-W

🍷 Available with wood seat, fabric cushion seat or leather cushion seat. If using your own fabric please supply ½ yard per chair. COM = Grade 3.

McCOY

EAT



SHOWN IN QUARTERSAWN WHITE OAK, MICHAEL'S

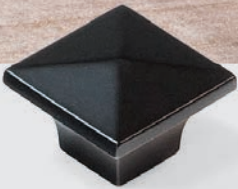

This style comes standard with Black Metal Knobs (WK-A-07).



a

Space Between Legs: 72" & 80" Table—45"; 96" Table—67"



b

a McCoy Trestle Table

Sizes below are available with four 12" leaves, 32" stationary butterfly leaf, or solid top.

1" thick top - standard.

- 42" w x 72" l MSMC4272-☞*
- 42" w x 80" l MSMC4280-☞*
- 42" w x 96" l MSMC4296-☞*
- 48" w x 72" l MSMC4872-☞*
- 48" w x 80" l MSMC4880-☞*
- 48" w x 96" l MSMC4896-☞*

b McCoy Island Table

54" w x 36" l x 36" h MSIMC54
(54" w x 54" l with leaf)

Features 18" stationary butterfly leaf, ball-bearing slides, leaf locks and one adjustable shelf behind doors.

1" thick top - standard.

SATE-60
Large Bevel

Default Table Edge Profile for all tables in this collection.

*Not available with butterfly leaf.

☞ Specify the number of leaves, butterfly leaf or solid top.



a



b



c



d



e



f

a McCoy Open Hutch *

Large Top

56" w x 16 1/4" d x 46 3/4" h ESMCC-K07

Large Base

60" w x 20" d x 34" h ESMCC-C03B

Extra Large Top (Not Shown)

72" w x 16 1/4" d x 46 3/4" h ESMCC-L07

Extra Large Base (Not Shown)

76" w x 20" d x 34" h ESMCC-C04B

Features glass shelf with plate grooves, 3-LED light system and one fixed shelf behind doors.

b McCoy 3-Door Dining Cabinet with Glass Doors *

57 3/4" w x 20 1/2" d x 51 1/4" h SCDCMC3G-

Features 2-LED light system, four drawers, beveled glass doors and adjustable glass shelf with plate groove.

McCoy 3-Door Dining Cabinet with Wood Doors (Not shown)

57 3/4" w x 20 1/2" d x 51 1/4" h SCDCMC3W

Features one adjustable wood shelf.

c McCoy 2-Door Dining Cabinet with Glass Doors *

41" w x 20 1/2" d x 51 1/4" h SCDCMC2G-

Features 2-LED light system, two drawers, beveled glass doors and adjustable glass shelf with plate groove.

McCoy 2-Door Dining Cabinet with Wood Doors (Not shown)

41" w x 20 1/2" d x 51 1/4" h SCDCMC2W

Features two drawers, and one adjustable wood shelf.

d Bradley Chair

Arm chair Arm Height: 25" h

25" w x 18 3/4" d x 44 1/2" h ECBRL-01A-

Side chair

19 1/2" w x 18" d x 44 1/2" h ECBRL-02A-

e Bradley Stationary Barstool

20" w x 19" d (back 20" h)

24" Seat Height ECBRL-04C-

30" Seat Height ECBRL-04B-

f McCoy Bench

36" w x 13 1/2" d x 18 1/4" h SAMC36B

48" w x 13 1/2" d x 18 1/4" h SAMC48B

60" w x 13 1/2" d x 18 1/4" h SAMC60B

72" w x 13 1/2" d x 18 1/4" h SAMC72B

McCoy Dining Bench

36" w x 17" d x 18" h ECMCC-12A-

48" w x 17" d x 18" h ECMCC-12B-

60" w x 17" d x 18" h ECMCC-12C-

72" w x 17" d x 18" h ECMCC-12D-

80" w x 17" d x 18" h ECMCC-12E-

Available with Beveled, Plain, Frosted, Water, or Antique Glass.

Available with wood seat, fabric cushion seat or leather cushion seat. If using your own fabric please supply 1/2 yard/chair. COM = Grade 3.

MONTAUK

EAT



C. Mont

SHOWN IN CHARACTER CHERRY, HAZELNUT



This style comes standard with Flat Black Pull (68-C-11).



a



b

Space Between Legs: 60" Table—18"; 72" Table—22"; 84" Table—37"; 96" Table—49"

a Montauk Trestle II Table

Rough Sawn & Plank Top Standard.

Sizes below are available with 18" stationary butterfly leaves on each end and solid top.

38" w x 60" l	ETMOK-I01D37A*	48" w x 60" l	ETMOK-I01D24A*
38" w x 72" l	ETMOK-I01D39-🍂	48" w x 72" l	ETMOK-I01D26-🍂
38" w x 84" l	ETMOK-I01D45-🍂	48" w x 84" l	ETMOK-I01D29-🍂
38" w x 96" l	ETMOK-I01D46-🍂	48" w x 96" l	ETMOK-I01D30-🍂
42" w x 60" l	ETMOK-I01D14A*		
42" w x 72" l	ETMOK-I01D16-🍂 ⇄ ⇄		
42" w x 84" l	ETMOK-I01D17-🍂		
42" w x 96" l	ETMOK-I01D18-🍂		

b Montauk Single Pedestal Table

Rough Sawn & Plank Top Standard.

Sizes below are available with a selection of 12" leaves, 18" sliding butterfly leaf, or solid top. Aprons are not available on single pedestal tables with a butterfly leaf.

1" thick top – standard.

42" Round	ETMOK-F06D12 🍂 (max 2)
48" Round	ETMOK-F06D22 🍂 (max 3)
54" Round	ETMOK-F06D32 🍂 (max 3)
60" Round	ETMOK-F06D34 🍂 (max 2)
72" Round	ETMOK-F06D36 🍂 (max 2)

🍂 Specify butterfly leaf or solid top. *Not available with butterfly leaf.



a



b



c

Shown with Olde World Level B Aging.



d

Shown with Olde World Level B Aging.



e

Shown with Olde World Level B Aging.



f

a Montauk Buffet

Rough Sawn & Plank Top Standard

60" w x 18 3/4" d x 36" h ESMOK-G27C

72" w x 18 3/4" d x 36" h ESMOK-G27D

Features two adjustable shelves on each side.

b Montauk Credenza

Rough Sawn & Plank Top Standard

60" w x 15 3/4" d x 36" h ESMOK-G23C

72" w x 15 3/4" d x 36" h ESMOK-G23D

Features two adjustable shelves on each side.

c Montauk Arm Chair

Arm Height: 25" h

24 1/2" w x 20 1/2" d x 39 1/2" h ECMOK-01A-

d Montauk Side Chair

19" w x 20 1/2" d x 39 1/2" h ECMOK-02A-

e Montauk Stationary Barstool

24" Seat Height; Seat Back: 20 1/2" h

18 1/2" w x 21 1/2" d ECMOK-04C-

f Montauk Trestle Dining Bench

Wood seat; Rough Sawn & Plank Top Standard.

48" w x 17" d x 18" h ECMOK-13B-W

60" w x 17" d x 18" h ECMOK-13C-W

72" w x 17" d x 18" h ECMOK-13D-W

84" w x 17" d x 18" h ECMOK-13F-W

96" w x 17" d x 18" h ECMOK-13G-W

 Available with wood seat, fabric cushion seat, or leather cushion seat. If using your own fabric please supply 1/2 yard per seat. COM = Grade 3.

NEW

MONTGOMERY

EAT



Chloe

SHOWN IN SOFT MAPLE, CLOUDY BAY WITH CHARCOAL TWO-TONE ACCENTS

Items in this collection are shown with 2-Tone option added.



This style comes standard with Ash Gray Pull (83-E-01)



a



b

SATE-40
Small Roundover Edge

Space Between Legs: 72" & 80" Table—42 $\frac{3}{4}$ "; 96" Table—64 $\frac{3}{4}$ "

a Montgomery Double Pedestal Table

Sizes below are available with a selection of 12" leaves, 18" stationary butterfly leaf on each end, or solid top.

38"w x 60"l	ETMTG-G01D37	48"w x 60"l	ETMTG-G01D24
42"w x 60"l	ETMTG-G01D14	48"w x 72"l	ETMTG-G01D26
42"w x 72"l	ETMTG-G01D16	48"w x 80"l	ETMTG-G01D28
42"w x 80"l	ETMTG-G01D44	48"w x 84"l	ETMTG-G01D29
42"w x 84"l	ETMTG-G01D17	48"w x 96"l	ETMTG-G01D30
42"w x 96"l	ETMTG-G01D18		

b Montgomery Trestle Table

Sizes below are available with four 12" leaves, 32" stationary butterfly leaf, 18" stationary butterfly leaf on each end, or solid top.

42"w x 72"l	ETMTG-H01D16
42"w x 80"l	ETMTG-H01D44
42"w x 96"l	ETMTG-H01D18
48"w x 72"l	ETMTG-H01D26
48"w x 80"l	ETMTG-H01D28
48"w x 96"l	ETMTG-H01D30

Specify leaves or solid top.



a Montgomery Buffet

Shelf behind each door.

71½" w x 19" d x 37½" h ESMTG-G16D

b Montgomery Dining Bench

36" w x 17" d x 18" h	ECMTG-15A-W
48" w x 17" d x 18" h	ECMTG-15B-W
60" w x 17" d x 18" h	ECMTG-15C-W
72" w x 17" d x 18" h	ECMTG-15D-W
80" w x 17" d x 18" h	ECMTG-15E-W

PARKDALE

EAT



CPM

SHOWN IN CHERRY, BOURBON



This style comes standard with Nickel Knob (70-B-25).



a

SATE-40
Small Roundover

Default Table Edge Profile for all tables in this collection.





b

a Parkdale Single Pedestal Table

Available with up to three 12" leaves, 18" sliding butterfly leaf, or solid top. On single pedestal tables with a butterfly leaf, there will be no apron on the leaf.

1" thick top—standard.

48" round ETPAR-E06D22-
54" round ETPAR-E06D32-
60" round (Max 2 Leaves) ETPAR-E06D34-

b Parkdale Double Pedestal Table

Available with two or four 12" leaves, or solid top.

1" thick top—standard.

48" w x 84" l ETPAR-G11D29-
48" w x 96" l ETPAR-G11D30-

 Specify the number of leaves, butterfly leaf, or solid top. *Not available with butterfly leaf.



a Parkdale Buffet

2 adjustable shelves on each side.

60" w x 17½" d x 36¼" h ESPAR-G11C
72" w x 17½" d x 36¼" h ESPAR-G11D

b Parkdale Credenza

2 adjustable shelves on each side.

60" w x 17½" d x 36" h ESPAR-H23C
72" w x 17½" d x 36" h ESPAR-H23D

c Claire Side Chair 

19" w x 26" d x 39" h

ECCLR-02A-

Skirt option available.
Nailhead options available.
Features Sinuous Springs.

 Available with wood seat, fabric cushion seat or leather cushion seat. If using your own fabric please supply 2½ yard. COM = Grade 3.

RIVERVIEW

EAT



R. Schrock

SHOWN IN SOFT MAPLE, SADDLE



This style comes standard with Nickel Pull (70-C-42).



a



Riverview Edge Profile

Space Between Legs: 48" & 54" Table—22"; 60" Table—30"; 72" & 80" Table—42"; 96" Table—54"

a Riverview Trestle II Table

Sizes below are available with two 12" leaves, four 12" leaves, or solid top.

1 1/4" thick top – standard.

36" w x 48" l	ETRIE-I01K03	☞ (max 2)	42" w x 84" l	ETRIE-I01K17
36" w x 72" l	ETRIE-I01K43	☞	42" w x 96" l	ETRIE-I01K18
38" w x 54" l	ETRIE-I01K27	☞ (max 2)	48" w x 60" l	ETRIE-I01K24
38" w x 60" l	ETRIE-I01K37	☞	48" w x 72" l	ETRIE-I01K26
38" w x 72" l	ETRIE-I01K39	☞	48" w x 84" l	ETRIE-I01K29
42" w x 60" l	ETRIE-I01K14	☞	48" w x 96" l	ETRIE-I01K30
42" w x 72" l	ETRIE-I01K16	☞		

☞ Specify the number of leaves or solid top.



a



b



c

a Riverview Leg Table

Sizes below are available with two 12" leaves, four 12" leaves, and solid top. Tables with four leaves will get a center leg.

1 1/4" thick top – standard.

38" w x 48" l	ETRIE-J01K05 (max 2)	42" w x 84" l	ETRIE-J01K17
38" w x 54" l	ETRIE-J01K27 (max 2)	48" w x 48" l	ETRIE-J01K22 (max 2)
38" w x 72" l	ETRIE-J01K39	48" w x 60" l	ETRIE-J01K24
38" w x 84" l	ETRIE-J01K45	48" w x 72" l	ETRIE-J01K26
40" w x 60" l	ETRIE-J01K07	48" w x 84" l	ETRIE-J01K29
42" w x 60" l	ETRIE-J01K14	54" w x 54" l	ETRIE-J01K32 (max 2)
42" w x 72" l	ETRIE-J01K16		

b Riverview Buffet

Features two shelves behind each door.

64" w x 19" d x 36" h	ESRIE-G11C
72" w x 19" d x 36" h	ESRIE-G11D

c Riverview Credenza

Features two shelves behind doors.

64" w x 19" d x 36" h	ESRIE-H23C
72" w x 19" d x 36" h	ESRIE-H23D

☞ Specify the number of leaves or solid top.

SHEFFIELD

EAT



SHEFFIELD DINING – SHOWN IN SOFT MAPLE, SILVER CREEK



This style comes standard with Brushed Pewter Pulls (82-B-01).



Rectangular Top

Eased Edge

a



Boat-Shaped Top

Eased Edge

b

a Sheffield Leg Table

Features one 18" leaf & Small Roundover Edge.

13/16" thick top – standard.

38"w x 54"L ETSHE-J01K27B

b Sheffield Boat Table

Features one 18" leaf & Small Roundover Edge.

13/16" thick top – standard.

42"w x 60"L ETSHE-J01K14B



Shown with Olde World Aging, Level B



a Sheffield 2-Door Sideboard
 46" w x 18" d x 37 3/4" h ESSHE-D18

b Sheffield Chair
 Arm chair Arm Height: 25 1/2"
 23 1/4" w x 22 1/4" d x 38" h SPSHA-
 Side chair
 18 3/4" w x 22 1/4" d x 38" h SPSHS-

c Sheffield Stationary Barstool
 18 1/2" w x 20 3/4" d; back 15" h
 24" Seat Height ECSHE-04C-
 30" Seat Height ECSHE-04B-

d Clifton Side Chair
 18" w x 21 1/2" d x 39 1/2" h ECCLI-02A-

e Mitchell Side Chair
 19" w x 21" d x 38 3/4" h ECMIT-02A-

f Waveland Side Chair
 19" w x 21" d x 38 3/4" h ECWAV-02A-

g Sheffield Dining Bench
 45" w x 14" d x 18" h ECSHE-16I-
 48" w x 14" d x 18" h ECSHE-16B-
 54" w x 14" d x 18" h ECSHE-16H-
 60" w x 14" d x 18" h ECSHE-16C-
 72" w x 14" d x 18" h ECSHE-16D-
 84" w x 14" d x 18" h ECSHE-16F-

Available with wood seat, fabric cushion seat or leather cushion seat. If using your own fabric please supply 1/2 yard/chair; 2 yards/bench. COM = Grade 3.

SHENANDOAH

EAT



CPM

SHOWN IN CHARACTER CHERRY, MICHAEL'S



This style comes standard with Black Knobs (WK-A-05).



a Shown with 1" radius shape top.















SATE-10
Large Roundover Edge

a Shenandoah Leg Table

Sizes below are available with two or four 12" leaves, 24" stationary butterfly leaf, or solid top. Tables with four leaves will get a center leg.

Features SATE-10, Large Roundover Edge.

13/16" thick top – standard.

38" w x 48" l	ETSHS-J04A05  * (max 2)	42" w x 84" l	ETSHS-J04A17 
38" w x 72" l	ETSHS-J04A39 	48" w x 48" l	ETSHS-J04A22  (max 2)
38" w x 84" l	ETSHS-J04A45 	48" w x 60" l	ETSHS-J04A24 
40" w x 60" l	ETSHS-J04A07 	48" w x 72" l	ETSHS-J04A26 
42" w x 60" l	ETSHS-J04A14 	48" w x 84" l	ETSHS-J04A29 
42" w x 72" l	ETSHS-J04A16 	54" w x 54" l	ETSHS-J04A32  (max 2)

 Specify the number of leaves, butterfly leaf or solid top. *Not available with butterfly leaf.



SATE-40
Small Roundover Edge



SATE-60
Large Bevel Edge

Shown with boat shape top.
Ends are 6" less than center.

SATE-40
Small Roundover Edge

Shown with 1" radius shape top.



b



c

Space Between Legs: 72" & 80" Table—45"

Space Between Legs: 48" Table—24"; 60" Table—32"; 72" Table—44";
84" Table—44"; 96" Table—56"

a Shenandoah Single Pedestal Table

Sizes below are available with a selection of 12" leaves, 18" sliding butterfly leaf, or solid top. Aprons are not available on single pedestal tables with a butterfly leaf.

- 13/16" thick top – standard.
- 38" Round ETSHS-F06D04 (max 2)
- 42" Round ETSHS-F06D12 (max 2)
- 48" Round ETSHS-F06D22 (max 3)
- 54" Round ETSHS-F06D32 (max 3)
- 60" Round ETSHS-F06D34 (max 2)
- 72" Round ETSHS-F06D36 (max 2)

b Shenandoah Trestle Table

Sizes below are available with four 12" leaves, 32" stationary butterfly leaf, or solid top.

- 13/16" thick top – standard.
- 42" w x 72" l ETSHS-H07F16-*
- 42" w x 80" l ETSHS-H07F44-*
- 48" w x 72" l ETSHS-H07F26-
- 48" w x 80" l ETSHS-H07F28-

c Shenandoah Trestle II Table

Sizes below are available with two or four 12" leaves, one 32" butterfly leaf or solid top.

- 13/16" thick top – standard.
- 36" w x 48" l ETSHS-I13D03-* (max 2)
- 36" w x 72" l ETSHS-I13D43-*
- 38" w x 60" l ETSHS-I13D37-*
- 38" w x 72" l ETSHS-I13D39-*
- 42" w x 60" l ETSHS-I13D14-*
- 42" w x 72" l ETSHS-I13D16-
- 42" w x 84" l ETSHS-I13D17-
- 42" w x 96" l ETSHS-I13D18-
- 48" w x 60" l ETSHS-I13D24-*
- 48" w x 72" l ETSHS-I13D26-
- 48" w x 84" l ETSHS-I13D22-
- 48" w x 96" l ETSHS-I13D30-

Specify the number of leaves, butterfly leaf or solid top. *Not available with butterfly leaf.





a



b



c

- a Shenandoah 2-Door Sideboard** 
 46" w x 18" d x 36½" h ESSHS-D18
 Features one full-width adjustable shelf behind doors.
- b Shenandoah 3-Door Sideboard** 
 54" w x 18" d x 36½" h ESSHS-D17
 Features one full-width adjustable shelf behind doors.

- c Shenandoah Closed Hutch, Large**
 Top: 60¼" w x 15¼" d x 46" h ESSHS-K06 
 Base: 60¼" w x 18¼" d x 34½" h ESSHS-C03B
 Features two adjustable glass shelves with plate grooves in top and one adjustable shelf behind doors in base.

 Available with Beveled, Plain, Frosted, Water, or Antique Glass.



a



b



c



d



e



f



g



h



i



j

a Mitchell Chair

Arm chair  Arm Height: 24½" 
24½" w x 21½" d x 38¾" h ECMIT-01A-

Side chair  
19" w x 21" d x 38¾" h ECMIT-02A-

b Mitchell Stationary Barstool

18½" w x 20¾" d; back 15" h

24" Seat Height ECMIT-04C-
30" Seat Height ECMIT-04B-

c Mitchell Swivel Barstool 

18½" w x 20¾" d; back 15" h

24" Seat Height ECMIT-06C-
30" Seat Height ECMIT-06B-

d Wright Side Chair  

18½" w x 22¾" d x 37¾" h ECWRI-02A-

e Wright Stationary Barstool

18½" w x 22¾" d; back 20¾" h

24" Seat Height ECWRI-04C-
30" Seat Height ECWRI-04B-

f Campbell Chair

Arm chair  Arm Height: 25½" h

23½" w x 21¼" d x 41" h ECCAM-01A-

Side Chair

19" w x 21¼" d x 41" h ECCAM-02A-

g Campbell Stationary Barstool

19" w x 21¼" d; back 21¼" h

24" Seat Height ECCAM-04C-
30" Seat Height ECCAM-04B-

h Shenandoah Side Chair

18¾" w x 20½" d x 35½" h ECSHS-02A-

i Shenandoah Stationary Barstool

18½" w x 21" d; back 18" h

24" Seat Height ECSHS-04C-
30" Seat Height ECSHS-04B-

j Shenandoah Dining Trestle Bench  

36" w x 17" d x 18" h ECSHS-13A-W

48" w x 17" d x 18" h ECSHS-13B-W

60" w x 17" d x 18" h ECSHS-13C-W

72" w x 17" d x 18" h ECSHS-13D-W

80" w x 17" d x 18" h ECSHS-13E-W

 Available with wood seat, fabric cushion seat or leather cushion seat. If using your own fabric please supply ½ yard per chair. COM = Grade 3.

WILDWOOD

EAT



CM

SHOWN IN SOFT MAPLE, BARNBOARD



This style comes standard with
Brushed Antique Copper Pull, 92-C-12



a

Space Between Legs: 66", 72" & 84" Table—45"; 96" Table—67"

a Wildwood Trestle Table

Solid top.

42" w x 66" l	ETWIL-H01D15A
42" w x 72" l	ETWIL-H01D16A
42" w x 84" l	ETWIL-H01D17A
42" w x 96" l	ETWIL-H01D18A
48" w x 66" l	ETWIL-H01D25A
48" w x 72" l	ETWIL-H01D26A
48" w x 84" l	ETWIL-H01D29A
48" w x 96" l	ETWIL-H01D30A

Features 2½" Edge Profile.



a

b



ECOSKIRT—Skirt Option available on select Upholstered Chairs



c



d

a Wildwood Buffet

60" w x 20" d x 34" h ESWIL-G23C
72" w x 20" d x 34" h ESWIL-G23D

Features one hidden drawer and one shelf on each side.

b Wildwood Credenza

60" w x 16" d x 34" h ESWIL-H23C
72" w x 16" d x 34" h ESWIL-H23D

Features two shelves on each side.

c Lana Side Chair

19" w x 26" d x 39" h ECLAN-02A-

Skirt option available. Nailhead options available.

Features Sinuous Springs.

d Wildwood Trestle Dining Bench

48" w x 16" d x 18" h ECWIL-13B-W
60" w x 16" d x 18" h ECWIL-13C-W
72" w x 16" d x 18" h ECWIL-13D-W
84" w x 16" d x 18" h ECWIL-13F-W
96" w x 16" d x 18" h ECWIL-13G-W

Features 2" Edge Profile.

 Available with fabric cushion seat or leather cushion seat. If using your own fabric please supply 2½ yards. COM = Grade 3.

MISC. TABLES

EAT



SHOWN IN SOFT MAPLE, SMOKE



a Sector 40" Round Table

Edge: SATE-80. 1" thick top - standard.
40" w x 40" d x 36" h ETSEC-E06H47A36

b Sector Stationary Barstool

18" w x 18" d x 24" h ECSEC-20C-
Sold individually.

c Adeline Single Pedestal Table with Glass Top

1/2" thick glass top with beveled edge.
48" Round MSAD-SP48G
54" Round MSAD-SP54G
60" Round MSAD-SP60G

d Brookfield Single Pedestal Table with Glass Top

1/2" thick glass top with beveled edge.
42" Round MSBR-SP42G
48" Round MSBR-SP48G
54" Round MSBR-SP54G
60" Round MSBR-SP60G

 Available with wood seat, fabric cushion seat or leather cushion seat. If using your own fabric please supply 1/2 yard. COM = Grade 3.



a

b



c

d

e

a Sofa/Dining Extension Table

48" w x 16" d x 30 3/4" h LOLSQ-41A06
 Features four 20" leaves and telescoping slides.
 Extends to 96" deep with all leaves in place.

b SYO Sofa/Dining Extension Table

48" w x 16" d x 30 3/4" h LOSSD-42I50
 Features removable center leg and four 20" leaves with telescoping slides.
 Extends to 96" deep with all leaves in place. See pg 361 for Edge and Leg options.

c Community Table

96" w x 32" d x 36" h ETCOM-N01D48A
 48" w x 32" d x 36" h ETCOM-N01D49A

d Community Backless Barstool

15" w x 15" d x 24" h ECCOM-08C-W

e Gathering Table

Available with up to six 18" leaves. 1" thick top - standard.
 46" w x 60" l MSGT4660-
 Comes with wood slides. Ball bearing slides not available.

Specify the number of leaves.

STUDIO LEG TABLES

STYLE YOUR OWN



STEP 1 | CHOOSE SIZE

TABLES

- 36" w x 36" l solid top PLL3636-S
- 36" w x 36" l two 10" leaves.... PLL3636-2
- 36" w x 48" l solid top PLL3648-S
- 36" w x 48" l two 10" leaves.... PLL3648-2
- 42" w x 42" l solid top PLL4242-S
- 42" w x 42" l two 10" leaves.... PLL4242-2
- 42" w x 48" l solid top PLL4248-S
- 42" w x 48" l two 10" leaves.... PLL4248-2

TABLE TOPS ARE 13/16" THICK.

END DROP LEAF TABLES

- 38" x 48" no center leaf...PLL3848DL-S
- 38" x 48" two 10" leaves...PLL3848DL-2
(38" x 30" with leaves down)
- 42" x 48" no center leaf...PLL4248DL-S
- 42" x 48" two 10" leaves...PLL4248DL-2
(42" x 30" with leaves down)

TABLE TOPS ARE 13/16" THICK.

STEP 2 | CHOOSE SHAPE

- Indicates where legs are located.

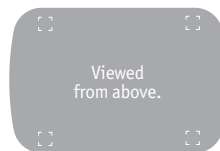

- Banquet SYO-BA**
Available only on 36"x48"
and 42"x48" tops.

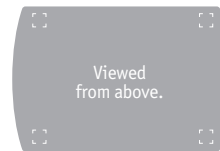

- Empire SYO-EM**
Available only on 36"x48"
and 42"x48" tops.

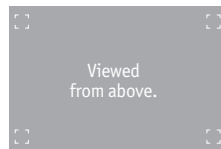

- Square Corner SYO-SQ**

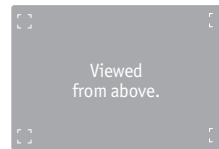

- 1" Radius Corner SYO-R1**

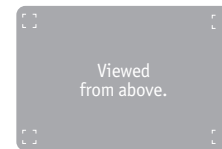

- 3" Radius Corner SYO-R3**

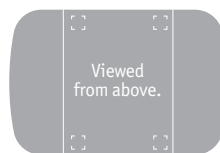

- Banquet SYO-BA**

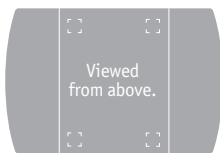

- Empire SYO-EM**

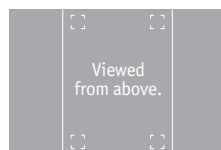

- Square Corner SYO-SQ**

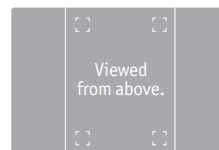

- 1" Radius Corner SYO-R1**

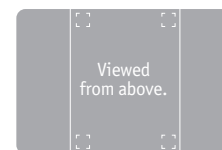

- 3" Radius Corner SYO-R3**

STEP 1 CHOOSE SIZE

SIDE DROP LEAF TABLES

(Not available with extra leaves.)

- 40" w x 54" l** PLL4054DL
(21½" w x 54" l with leaves down, 29" between the legs)
- 40" w x 60" l** PLL4060DL
(21½" w x 60" l with leaves down, 35" between the legs)
- 40" w x 66" l** PLL4066DL
(21½" w x 66" l with leaves down, 41" between the legs)
- 40" w x 72" l** PLL4072DL
(21½" w x 72" l with leaves down, 47" between the legs)
- 48" w x 54" l** PLL4854DL
(29½" w x 54" l with leaves down, 29" between the legs)
- 48" w x 60" l** PLL4860DL
(29½" w x 60" l with leaves down, 35" between the legs)
- 48" w x 66" l** PLL4866DL
(29½" w x 66" l with leaves down, 41" between the legs)
- 48" w x 72" l** PLL4872DL
(29½" w x 72" l with leaves down, 47" between the legs)

TABLE TOPS ARE 13/16" THICK.

STEP 2 CHOOSE SHAPE

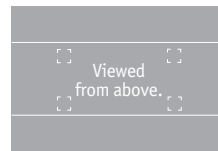

Square Corner SYO-SQ

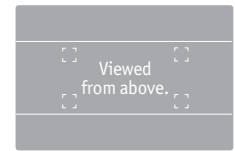

1" Radius Corner SYO-R1

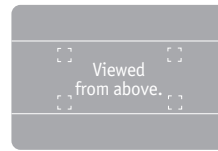

3" Radius Corner SYO-R3

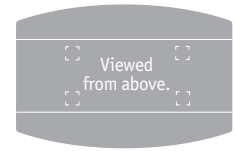

Boat SYO-B0

☐ - Indicates where legs are located.

EAT

SYO TABLES

STEP 3 CHOOSE EDGE



Large Roundover SATE-10

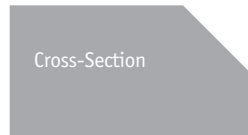

Small Bevel SATE-30

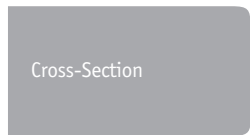

Small Roundover SATE-40



Lipped SATE-50



Large Bevel SATE-60
Not available on drop leaf tables

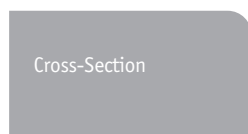

Medium Roundover SATE-80

STEP 4 CHOOSE LEG



a



b



c



d

a **Loft II**

- table height PLL-SC30
- counter height PLL-SC36

c **Small Square-Tapered**

- table height PLL-SS30
- counter height PLL-SS36

b **Small Square**

- table height PLL-SE30
- counter height PLL-SE36

d **Turned**

- table height PLL-TL30
- counter height PLL-TL36

Studio Leg table legs are 2½" x 2½" at the apron. Aprons are 2½" h.

STUDIO PEDESTAL TABLES

STYLE YOUR OWN



STEP 1 | CHOOSE SIZE

TABLES

- 36" w x 36" l solid top PLS3636-S
- 36" w x 36" l two 10" leaves . PLS3636-2

- 36" w x 48" l solid top PLS3648-S
- 36" w x 48" l two 10" leaves . PLS3648-2

- 42" w x 42" l solid top PLS4242-S
- 42" w x 42" l two 10" leaves . PLS4242-2

- 42" w x 48" l solid top PLS4248-S
- 42" w x 48" l two 10" leaves . PLS4248-2

TABLE TOPS ARE 13/16" THICK.

DROP LEAF TABLES

- 38" x 48" no leaves PLS3848DL-S
- 38" x 48" two 10" leaves PLS3848DL-2
(38" x 30" with drop leaves down)

- 42" x 48" no leaves PLS4248DL-S
- 42" x 48" two 10" leaves PLS4248DL-2
(42" x 30" with drop leaves down)

TABLE TOPS ARE 13/16" THICK.

STEP 2 | CHOOSE SHAPE

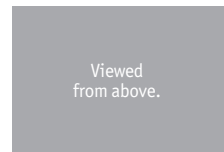

Square Corner SYO-SQ

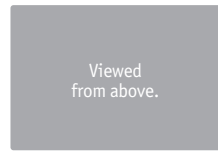

1" Radius Corner SYO-R1

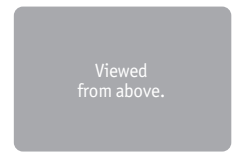

3" Radius Corner SYO-R3

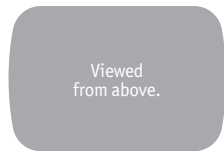

Banquet SYO-BA

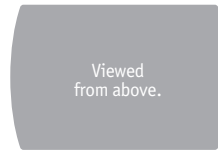

Empire SYO-EM



Round SYO-RO

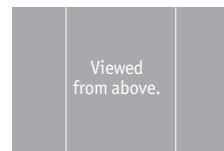

Square Corner SYO-SQ

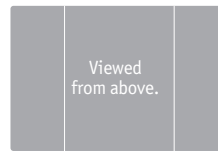

1" Radius Corner SYO-R1



3" Radius Corner SYO-R3

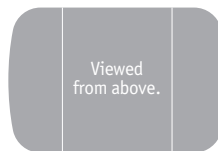

Banquet SYO-BA



Empire SYO-EM

STEP 1 CHOOSE SIZE

ROUND DROP LEAF TABLES

- 42" Round** no leaves PLS42RDL
(24" w x 42" l with leaves down)
- 48" Round** no leaves PLS48RDL
(30" w x 48" l with leaves down)

TABLE TOPS ARE 13/16" THICK.

STEP 2 CHOOSE SHAPE

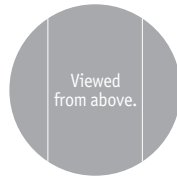

STEP 3 CHOOSE EDGE



Large Roundover SATE-10



Small Bevel SATE-30

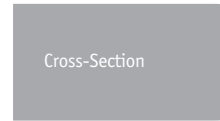

Small Roundover SATE-40



Lipped SATE-50



Large Bevel SATE-60
Not available on drop leaf tables

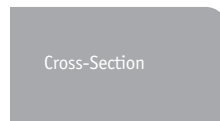

Medium Roundover SATE-80

STEP 4 CHOOSE PEDESTAL



a



b



c



d



e

a Albany

- table height PLS-AL30
- counter height PLS-AL36
- bar height PLS-AL42

c Mission

- table height PLS-MI30
- counter height PLS-MI36
- bar height PLS-MI42

e Traditional

- table height PLS-TR30
- counter height PLS-TR36
- bar height PLS-TR42

b Grace

- table height PLS-GR30
- counter height PLS-GR36
- bar height PLS-GR42

d Prairie Mission

- table height PLS-PM30
- counter height PLS-PM36
- bar height PLS-PM42

LEG TABLES

STYLE YOUR OWN



Shown with: Square Corner Top, Justine Leg, 3/8" Apron Set Back Option

STEP 1 | CHOOSE SIZE

Note: Ball Bearing Slides - Standard unless noted.

<input type="checkbox"/> 38" w x 48" l solid top	SAL3848-S*	<input type="checkbox"/> 42" w x 84" l solid top	SAL4284-S
<input type="checkbox"/> 38" w x 48" l two 12" leaves	SAL3848-2*	<input type="checkbox"/> 42" w x 84" l two 12" leaves	SAL4284-2
<input type="checkbox"/> 38" w x 54" l solid top	SAL3854-S*	<input type="checkbox"/> 42" w x 84" l four 12" leaves and center leg	SAL4284-4
<input type="checkbox"/> 38" w x 54" l two 12" leaves	SAL3854-2*	<input type="checkbox"/> 42" w x 84" l one 24" stationary butterfly leaf	SAL4284-BF
<input type="checkbox"/> 38" w x 54" l one 18" leaf	SAL3854-B*	<input type="checkbox"/> 48" w x 48" l solid top	SAL4848-S
<input type="checkbox"/> 38" w x 72" l solid top	SAL3872-S	<input type="checkbox"/> 48" w x 48" l two 12" leaves	SAL4848-2
<input type="checkbox"/> 38" w x 72" l two 12" leaves	SAL3872-2	<input type="checkbox"/> 48" w x 48" l one 24" stationary butterfly leaf	SAL4848-BF
<input type="checkbox"/> 38" w x 72" l four 12" leaves and center leg	SAL3872-4	(48" w x 72" l with butterfly leaf)	
<input type="checkbox"/> 38" w x 72" l one 24" stationary butterfly leaf	SAL3872-BF	<input type="checkbox"/> 48" w x 60" l solid top	SAL4860-S
<input type="checkbox"/> 38" w x 84" l solid top	SAL3884-S	<input type="checkbox"/> 48" w x 60" l two 12" leaves and ball bearing slides	SAL4860-2
<input type="checkbox"/> 38" w x 84" l two 12" leaves	SAL3884-2	<input type="checkbox"/> 48" w x 60" l four 12" leaves, center leg and ball bearing slides	SAL4860-4
<input type="checkbox"/> 38" w x 84" l four 12" leaves and center leg	SAL3884-4	<input type="checkbox"/> 48" w x 60" l three 24" leaves, center leg and wood slides	SAL4860-G
<input type="checkbox"/> 38" w x 84" l one 24" stationary butterfly leaf	SAL3884-BF	<input type="checkbox"/> 48" w x 60" l four 24" leaves, 2 center legs and wood slides	SAL4860-I
<input type="checkbox"/> 40" w x 60" l solid top	SAL4060-S*	<input type="checkbox"/> 48" w x 60" l five 24" leaves, 4 center legs and wood slides	SAL4860-K
<input type="checkbox"/> 40" w x 60" l two 12" leaves	SAL4060-2*	<input type="checkbox"/> 48" w x 60" l six 24" leaves, 4 center legs and wood slides	SAL4860-L
<input type="checkbox"/> 40" w x 60" l four 12" leaves and center leg	SAL4060-4*	<input type="checkbox"/> 48" w x 60" l one 24" stationary butterfly leaf and ball bearing slides ..	SAL4860-BF
<input type="checkbox"/> 40" w x 60" l one 24" stationary butterfly leaf	SAL4060-BF**	(48" w x 84" l with butterfly leaf)	
Available with two self-storing leaves with no aprons		SA02SS	Available with two self-storing leaves with no aprons
<input type="checkbox"/> 42" w x 60" l solid top	SAL4260-S	<input type="checkbox"/> 48" w x 72" l solid top	SAL4872-S
<input type="checkbox"/> 42" w x 60" l two 12" leaves	SAL4260-2	<input type="checkbox"/> 48" w x 72" l two 12" leaves	SAL4872-2
<input type="checkbox"/> 42" w x 60" l four 12" leaves and center leg	SAL4260-4	<input type="checkbox"/> 48" w x 72" l four 12" leaves and center leg	SAL4872-4
<input type="checkbox"/> 42" w x 60" l one 24" stationary butterfly leaf	SAL4260-BF	<input type="checkbox"/> 48" w x 72" l one 24" stationary butterfly leaf	SAL4872-BF
(42" w x 84" l with butterfly leaf)		(48" w x 96" l with butterfly leaf)	
Available with two self-storing leaves with no aprons		SA02SS	Available with two self-storing leaves with no aprons
<input type="checkbox"/> 42" w x 72" l solid top	SAL4272-S	<input type="checkbox"/> 48" w x 72" l four 12" leaves and center leg	SAL4884-2
<input type="checkbox"/> 42" w x 72" l two 12" leaves	SAL4272-2	<input type="checkbox"/> 48" w x 84" l two 12" leaves	SAL4884-2
<input type="checkbox"/> 42" w x 72" l four 12" leaves and center leg	SAL4272-4	<input type="checkbox"/> 48" w x 84" l four 12" leaves and center leg	SAL4884-4
<input type="checkbox"/> 42" w x 72" l one 24" stationary butterfly leaf	SAL4272-BF	<input type="checkbox"/> 48" w x 84" l one 24" stationary butterfly leaf	SAL4884-BF
(42" w x 96" l with butterfly leaf)		(48" w x 84" l with butterfly leaf)	
Available with two self-storing leaves with no aprons		SA02SS	Available with two self-storing leaves with no aprons
<input type="checkbox"/> 48" w x 84" l solid top	SAL4884-S	<input type="checkbox"/> 54" w x 54" l solid top	SAL5454-S
<input type="checkbox"/> 48" w x 84" l two 12" leaves	SAL4884-2	<input type="checkbox"/> 54" w x 54" l two 12" leaves	SAL5454-2
<input type="checkbox"/> 48" w x 84" l four 12" leaves and center leg	SAL4884-4	<input type="checkbox"/> 54" w x 54" l one 24" stationary butterfly leaf	SAL5454-BF
<input type="checkbox"/> 48" w x 84" l one 24" stationary butterfly leaf	SAL4884-BF		

TABLE TOPS ARE 13/16" THICK. ALSO AVAILABLE IN 1 1/2" THICK. * Not available with butterfly leaf. ** Not available with boat shaped top.
 BUTTERFLY LEAVES NOT AVAILABLE ON 1 1/2" THICK TOPS. BALL BEARING SLIDES - STANDARD UNLESS OTHERWISE NOTED.

Leg Layouts

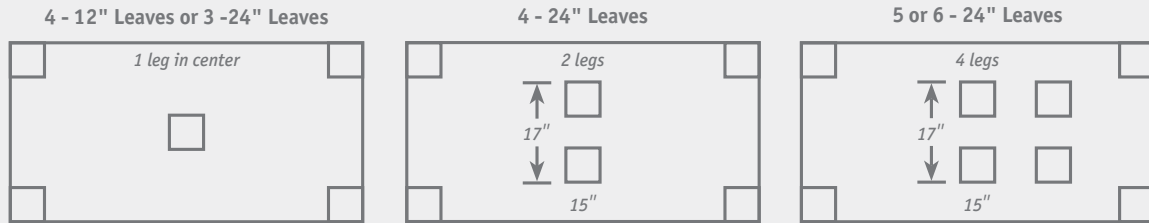

STEP 2 CHOOSE SHAPE

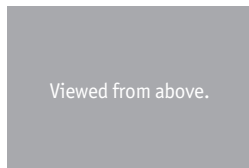

Square Corner SYO-SQ

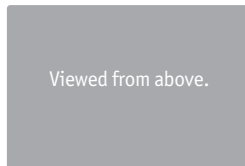

1" Radius Corner SYO-R1

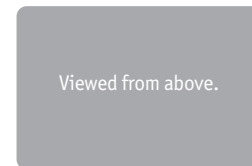

3" Radius Corner SYO-R3

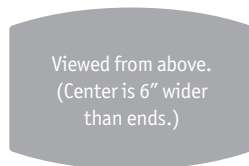

Boat SYO-B0

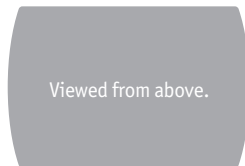

Empire SYO-EM

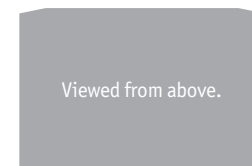

Shaker Hill Top SYO-SH

Optional ebony inlay SAOEI (Aspen Style) available.

STEP 3 CHOOSE EDGE



Large Roundover SATE-10



Underside Bevel SATE-20

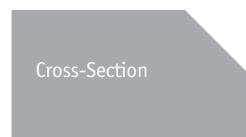

Small Bevel SATE-30

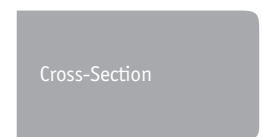

Small Roundover SATE-40



Lipped SATE-50



Large Bevel SATE-60



Queen Anne SATE-70

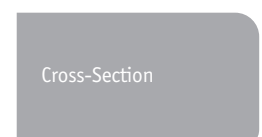

Medium Roundover SATE-80

STEP 4 CHOOSE LEG



a Avalon (2½" Square Top)

<input type="checkbox"/>	table height	SAL-AV30
<input type="checkbox"/>	counter height	SAL-AV36
<input type="checkbox"/>	bar height	SAL-AV42

c Loft (3½" Square Top)

<input type="checkbox"/>	table height	SAL-CR30
<input type="checkbox"/>	counter height	SAL-CR36
<input type="checkbox"/>	bar height	SAL-CR42

e Fenton (3" Square Top)

<input type="checkbox"/>	table height	SAL-FE30
<input type="checkbox"/>	counter height	SAL-FE36
<input type="checkbox"/>	bar height	SAL-FE42

g Irvington (3½" Square Top)

<input type="checkbox"/>	table height	SAL-IR30
<input type="checkbox"/>	counter height	SAL-IR36
<input type="checkbox"/>	bar height	SAL-IR42

b Chatham (5" Square Top)

<input type="checkbox"/>	table height	SAL-CH30
<input type="checkbox"/>	counter height	SAL-CH36
<input type="checkbox"/>	bar height	SAL-CH42

d Chesterville (3½" Square Top)

<input type="checkbox"/>	table height	SAL-CV30
<input type="checkbox"/>	counter height	SAL-CV36
<input type="checkbox"/>	bar height	SAL-CV42

f Farm-Turned (3½" Square Top)

<input type="checkbox"/>	table height	SAL-FT30
<input type="checkbox"/>	counter height	SAL-FT36
<input type="checkbox"/>	bar height	SAL-FT42

h Justine (2½" Square Top)

<input type="checkbox"/>	table height	SAL-JS30
<input type="checkbox"/>	counter height	SAL-JS36
<input type="checkbox"/>	bar height	SAL-JS42

STEP 5 OPTIONS

Edge Apron SYO-APRON

This option moves the apron out closer to the edge of the table and leaves a ¾" overhang. It is available only on Leg tables in Style Your Own and is only available on the square corner table shape because the leg will be very near to the edge of the table.

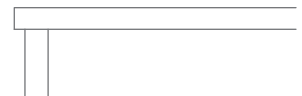

STEP 4 CHOOSE LEG (CONTINUED)



i



j



k



l



m



n



o



p



q

i Plain Round (3 1/2" Square Top)

<input type="checkbox"/>	table height	SAL-PR30
<input type="checkbox"/>	counter height	SAL-PR36
<input type="checkbox"/>	bar height	SAL-PR42

j Reeded (3 1/2" Square Top)

<input type="checkbox"/>	table height	SAL-RE30
--------------------------	--------------	----------

k Loft II (2 1/2" Square Top)

<input type="checkbox"/>	table height	SAL-SC30
<input type="checkbox"/>	counter height	SAL-SC36
<input type="checkbox"/>	bar height	SAL-SC42

l Small Square (2 1/2" Square Top)

<input type="checkbox"/>	table height	SAL-SE30
<input type="checkbox"/>	counter height	SAL-SE36
<input type="checkbox"/>	bar height	SAL-SE42

m Medium Square (3 1/2" Square Top)

<input type="checkbox"/>	table height	SAL-SM30
<input type="checkbox"/>	counter height	SAL-SM36
<input type="checkbox"/>	bar height	SAL-SM42

n Large Square (5" Square Top)

<input type="checkbox"/>	table height	SAL-SQ30
<input type="checkbox"/>	counter height	SAL-SQ36
<input type="checkbox"/>	bar height	SAL-SQ42

o Small Square-Tapered (2 1/2" Square Top)

<input type="checkbox"/>	table height	SAL-SS30
<input type="checkbox"/>	counter height	SAL-SS36
<input type="checkbox"/>	bar height	SAL-SS42

p Square-Tapered (3 1/2" Square Top)

<input type="checkbox"/>	table height	SAL-ST30
<input type="checkbox"/>	counter height	SAL-ST36
<input type="checkbox"/>	bar height	SAL-ST42

q Savannah (5" Square Top)

<input type="checkbox"/>	table height	SAL-SV30
<input type="checkbox"/>	counter height	SAL-SV36
<input type="checkbox"/>	bar height	SAL-SV42

STEP 5 OPTIONS (CONTINUED)

25 3/4" Arm Chair Clearance Option SAOARM

Use ONLY when chair arm height exceeds 25 3/4". This raises the table height by 1", allowing the arm chair to clear the apron of the table, at 26 1/4" off the floor. Apron will remain at 3".

PEDESTAL TABLES

STYLE YOUR OWN



Shown with: Round Top, Small Roundover Edge, and Napa Base

STEP 1 | CHOOSE SIZE

Note: Ball Bearing Slides - Standard.

- 38" solid topSAS38-S
- 38" one 12" leafSAS38-1
- 38" two 12" leavesSAS38-2

- 42" solid topSAS42-S
- 42" one 12" leafSAS42-1
- 42" two 12" leavesSAS42-2

- 48" solid topSAS48-S
- 48" one 12" leafSAS48-1
- 48" two 12" leavesSAS48-2
- 48" three 12" leavesSAS48-3
- 48" one 18" butterfly leafSAS48-BF

- 54" solid topSAS54-S
- 54" one 12" leafSAS54-1
- 54" two 12" leavesSAS54-2
- 54" three 12" leavesSAS54-3
- 54" one 18" butterfly leafSAS54-BF

- 60" solid topSAS60-S
- 60" one 12" leafSAS60-1
- 60" two 12" leavesSAS60-2
- 60" one 18" butterfly leafSAS60-BF

- 72" without leavesSAS72-S
- 72" one 12" leafSAS72-1
- 72" two 12" leavesSAS72-2
- 72" one 18" butterfly leafSAS72-BF

Note: All butterfly leaves on single pedestal tables are sliding butterfly leaves and do not have aprons. Note: Self storing leaves not available.

TABLE TOPS ARE 1" THICK. ALSO AVAILABLE IN 1½" THICK. BUTTERFLY LEAVES NOT AVAILABLE ON 1½" THICK TOPS

STEP 2 | CHOOSE SHAPE

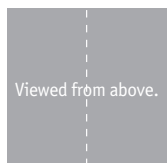

Square Corner SY0-SQ



1" Radius Corner SY0-R1



3" Radius Corner SY0-R3



Banquet SY0-BA



Boat SY0-B0

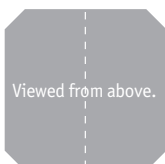

Clipped SY0-CL
Clipped Corner 8½" long

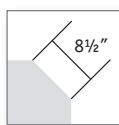

Empire SY0-EM

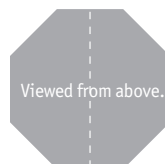

Octagonal SY0-OC
Available in 54", 60", and 72"



Round SY0-R0

STEP 3 CHOOSE EDGE



Large Roundover SATE-10



Underside Bevel SATE-20



Small Bevel SATE-30

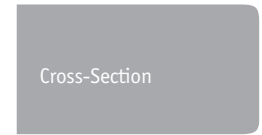

Small Roundover SATE-40



Lipped SATE-50



Large Bevel SATE-60



Queen Anne SATE-70

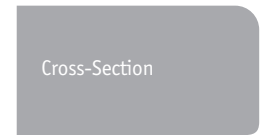

Medium Roundover SATE-80

STEP 4 CHOOSE PEDESTAL BASE (CONTINUED ON NEXT PAGE)



a



b



c



d



e



f

a Adeline

Required for 48" tables

- table height SAS-AD30
 - counter height SAS-AD36
 - bar height SAS-AD42
- Not Available in 38", 42"

Adeline - Deluxe

Required for 54", 60", and 72" tables

- table height SAS-ADD30

b Albany

Required for 38", 42", and 48" tables

- table height SAS-AL30
- counter height SAS-AL36
- bar height SAS-AL42

Albany - Deluxe

Required for 54", 60", and 72" tables

- table height SAS-ALD30

c Avalon

Required for 38", 42", and 48" tables

- table height SAS-AV30
- counter height SAS-AV36
- bar height SAS-AV42

Avalon - Deluxe

Required for 54", 60", and 72" tables

- table height SAS-AVD30

d Brookfield

Required for 42", and 48" tables

- table height SAS-BF30
 - counter height SAS-BF36
 - bar height SAS-BF42
- Not Available in 38"

Brookfield - Deluxe

Required for 54", 60", and 72" tables

- table height SAS-BFD30

e Charleston

Required for 38", 42", and 48" tables

- table height SAS-CH30
- counter height SAS-CH36
- bar height SAS-CH42

Charleston - Deluxe

Required for 54", 60", and 72" tables

- table height SAS-CHD30

f Crawford

Required for 42", and 48" tables

- table height SAS-CD30
 - counter height SAS-CD36
 - bar height SAS-CD42
- Not Available in 38"

Crawford - Deluxe

Required for 54", 60", and 72" tables

- table height SAS-CDD30



g



h



i



j



k



l

g Easton

Required for 48" tables

Table height SAS-EA30

Not Available in 38" or 42"

Easton - Deluxe

Required for 54", 60", and 72" tables

Table height SAS-EAD30

h Franciscan

Required for 42", and 48" tables

table height SAS-FR30

counter height SAS-FR36

bar height SAS-FR42

Not Available in 38"

Franciscan - Deluxe

Required for 54", 60", and 72" tables

table height SAS-FRD30

i Grace

Required for 38", 42", and 48" tables

table height SAS-GR30

counter height SAS-GR36

bar height SAS-GR42

Grace - Deluxe

Required for 54" and 60" tables

table height SAS-GRD30

Not Available in 72"

j Haley

Required for 48" tables

Table height SAS-HA30

Not Available in 38" or 42"

Haley - Deluxe

Required for 54", 60", and 72" tables

Table height SAS-HAD30

k Loft II

Required for 48" tables

table height SAS-L230

counter height SAS-L236

Not Available in 38" or 42"

Loft II - Deluxe

Required for 54" and 60" tables

table height SAS-L2D30

Not Available in 72"

l Mission

Required for 38", 42", and 48" tables

table height SAS-MI30

counter height SAS-MI36

bar height SAS-MI42

Mission - Deluxe

Required for 54", 60", and 72" tables

table height SAS-MID30



m



n



o



p



q



r

m Napa

Required for 48" tables

Table height SAS-NA30

Not Available in 38" or 42"

Napa - Deluxe

Required for 54", 60", and 72" tables

Table height SAS-NAD30

n Park Avenue

Required for 42", and 48" tables

table height SAS-PK30

counter height SAS-PK36

Not Available in 38"

Park Avenue - Deluxe

Required for 54" and 60" tables

table height SAS-PKD30

Not Available in 72"

o Parkdale

Required for 48" tables

table height SAS-PD30

counter height SAS-PD36

Not Available in 38", 42"

Parkdale - Deluxe

Required for 54", 60", and 72" tables

table height SAS-PDD30

p Prairie Mission

Required for 38", 42", and 48" tables

table height SAS-PM30

counter height SAS-PM36

bar height SAS-PM42

Prairie Mission - Deluxe

Required for 54" and 60" tables

table height SAS-PMD30

Not Available in 72"

q Traditional

Required for 38", 42", and 48" tables

table height SAS-TR30

counter height SAS-TR36

bar height SAS-TR42

Traditional - Deluxe

Required for 54" & 60", and 72" tables

table height SAS-TRD30

r Valhalla

Required for 48" tables

table height SAS-VA30

counter height SAS-VA36

Not Available in 38" and 42"

Valhalla - Deluxe

Required for 54", 60", and 72" tables

table height SAS-VAD30

DOUBLE PEDESTAL TABLES

STYLE YOUR OWN



Shown with: Square Corner Top, Small Roundover Edge, and Crawford Base

STEP 1 | CHOOSE SIZE

Note: Ball Bearing Slides - Standard.

- 38" w x 60" l solid top SAD3860-S
- 38" w x 60" l two 12" leaves SAD3860-2
- 38" w x 60" l four 12" leaves SAD3860-4
- 38" w x 60" l 18" stationary butterfly leaf on each end..... SAD3860-Q*
- Available with two self-storing leaves with no aprons SA02SS
- 42" w x 60" l solid top SAD4260-S
- 42" w x 60" l two 12" leaves SAD4260-2
- 42" w x 60" l four 12" leaves SAD4260-4
- 42" w x 60" l 18" stationary butterfly leaf on each end..... SAD4260-Q*
- Available with two self-storing leaves with no aprons SA02SS
- 42" w x 72" l solid top SAD4272-S
- 42" w x 72" l two 12" leaves SAD4272-2
- 42" w x 72" l four 12" leaves SAD4272-4
- 42" w x 72" l 18" stationary butterfly leaf on each end..... SAD4272-Q*
- Available with two self-storing leaves with no aprons SA02SS
- 42" w x 80" l solid top SAD4280-S
- 42" w x 80" l two 12" leaves SAD4280-2
- 42" w x 80" l four 12" leaves SAD4280-4
- 42" w x 80" l 18" stationary butterfly leaf on each end..... SAD4280-Q*
- Available with two self-storing leaves with no aprons SA02SS
- 42" w x 84" l solid top SAD4284-S
- 42" w x 84" l two 12" leaves SAD4284-2
- 42" w x 84" l four 12" leaves SAD4284-4
- 42" w x 84" l 18" stationary butterfly leaf on each end..... SAD4284-Q*
- Available with two self-storing leaves with no aprons SA02SS
- 42" w x 96" l solid top SAD4296-S
- 42" w x 96" l two 12" leaves SAD4296-2
- 42" w x 96" l four 12" leaves SAD4296-4
- 42" w x 96" l 18" stationary butterfly leaf on each end..... SAD4296-Q*
- Available with two self-storing leaves with no aprons SA02SS

- 48" w x 60" l solid top SAD4860-S
- 48" w x 60" l two 12" leaves SAD4860-2
- 48" w x 60" l four 12" leaves SAD4860-4
- 48" w x 60" l 18" stationary butterfly leaf on each end..... SAD4860-Q*
- Available with two self-storing leaves with no aprons SA02SS
- 48" w x 72" l solid top SAD4872-S
- 48" w x 72" l two 12" leaves SAD4872-2
- 48" w x 72" l four 12" leaves SAD4872-4
- 48" w x 72" l 18" stationary butterfly leaf on each end..... SAD4872-Q*
- Available with two self-storing leaves with no aprons SA02SS
- Available with four self-storing leaves
- two with aprons and two without SA04SSA
- 48" w x 80" l solid top SAD4880-S
- 48" w x 80" l two 12" leaves SAD4880-2
- 48" w x 80" l four 12" leaves SAD4880-4
- 48" w x 80" l 18" stationary butterfly leaf on each end..... SAD4880-Q*
- Available with two self-storing leaves with no aprons SA02SS
- Available with four self-storing leaves
- two with aprons and two without SA04SSA
- Available with four self-storing leaves with no aprons SA04SS
- 48" w x 84" l solid top SAD4884-S
- 48" w x 84" l two 12" leaves SAD4884-2
- 48" w x 84" l four 12" leaves SAD4884-4
- 48" w x 84" l 18" stationary butterfly leaf on each end..... SAD4884-Q*
- Available with two self-storing leaves with no aprons SA02SS
- Available with four self-storing leaves
- two with aprons and two without SA04SSA
- Available with four self-storing leaves with no aprons SA04SS
- 48" w x 96" l solid top SAD4896-S
- 48" w x 96" l two 12" leaves SAD4896-2
- 48" w x 96" l four 12" leaves SAD4896-4
- 48" w x 96" l 18" stationary butterfly leaf on each end..... SAD4896-Q*
- Available with two self-storing leaves with no aprons SA02SS
- Available with four self-storing leaves
- two with aprons and two without SA04SSA
- Available with four self-storing leaves with no aprons SA04SS

*Only Available on Rectangle Top with Square Corner and edge SATE-40 or 80
 Note: In some cases the pedestal you choose may limit to storing four leaves with no aprons.

TABLE TOPS ARE 1" THICK.
 ALSO AVAILABLE IN 1½" THICK.
 BUTTERFLY LEAVES NOT AVAILABLE ON 1½" THICK TOPS.

STEP 2 CHOOSE TABLE TOP SHAPE

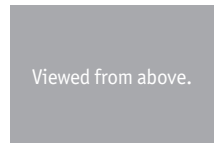

Square Corner SY0-SQ

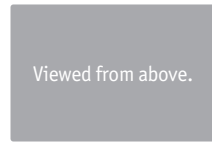

1" Radius Corner SY0-R1

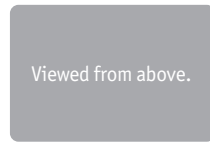

3" Radius Corner SY0-R3



Banquet SY0-BA

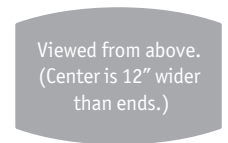

Boat SY0-B0
Available with optional ebony inlay SAOEI (Aspen Style)

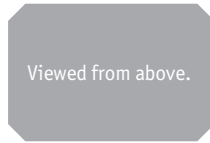

Clipped Corners SY0-CL

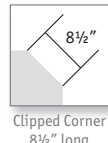

Clipped Corner
8 1/2" long

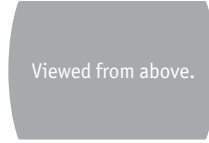

Empire SY0-EM

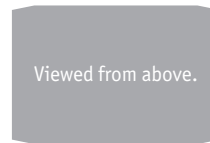

Shaker Hill SY0-SH



Oval SY0-OV

STEP 3 CHOOSE EDGE



Large Roundover SATE-10



Underside Bevel SATE-20

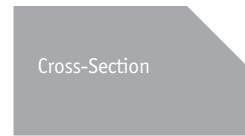

Small Bevel SATE-30

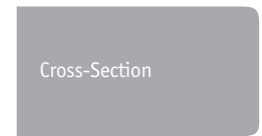

Small Roundover SATE-40



Lipped SATE-50



Large Bevel SATE-60



Queen Anne SATE-70

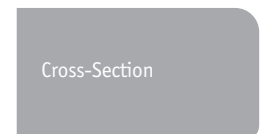

Medium Roundover SATE-80

STEP 4 CHOOSE DOUBLE PEDESTAL BASE (CONTINUED ON NEXT PAGE)



a



b



c

a Albany

- table height SAD-AL30
- counter height SAD-AL36
- bar height SAD-AL42

b Avalon

- table height SAD-AV30
 - counter height SAD-AV36
 - bar height SAD-AV42
- No aprons on self-storing leaves.

c Brookfield

- table height SAD-BF30
 - counter height SAD-BF36
 - bar height SAD-BF42
- Not available on 38" w x 60" l.
Not available on 42" w x 60" l.
No aprons on self-storing leaves.



d



e



f



g



h



i



j

d Charleston

<input type="checkbox"/>	table height	SAD-CH30
<input type="checkbox"/>	counter height	SAD-CH36
<input type="checkbox"/>	bar height	SAD-CH42

No aprons on self-storing leaves.

e Claw Foot

<input type="checkbox"/>	table height	SAD-CR30
<input type="checkbox"/>	counter height	SAD-CR36
<input type="checkbox"/>	bar height	SAD-CR42

Available in oak, cherry and maple.
Not available in 60"L.

f Crawford

<input type="checkbox"/>	table height	SAD-CD30
<input type="checkbox"/>	counter height	SAD-CD36
<input type="checkbox"/>	bar height	SAD-CD42

g Easton

<input type="checkbox"/>	table height	SAD-EA30
--------------------------	--------------	----------

h Franciscan

<input type="checkbox"/>	table height	SAD-FR30
<input type="checkbox"/>	counter height	SAD-FR36
<input type="checkbox"/>	bar height	SAD-FR42

No aprons on self-storing leaves.

i Grace

<input type="checkbox"/>	table height	SAD-GR30
<input type="checkbox"/>	counter height	SAD-GR36
<input type="checkbox"/>	bar height	SAD-GR42

j Haley

<input type="checkbox"/>	table height	SAD-HA30
--------------------------	--------------	----------



k



l



m



n



o



p

k Loft II

- table height SAD-L230
- counter height SAD-L236

Supports up to two self-storing leaves.
No aprons on self-storing leaves.
72" Max Length.

l Mission Slats

- table height SAD-MS30
- counter height SAD-MS36
- bar height SAD-MS42

m Napa

- table height SAD-NA30

n Prairie Mission

- table height SAD-PM30
- counter height SAD-PM36
- bar height SAD-PM42

o Traditional

- table height SAD-PR30
- counter height SAD-PR36
- bar height SAD-PR42

p Parkdale

- table height SAD-PD30
- counter height SAD-PD36
- bar height SAD-PD42

TRESTLE TABLES

STYLE YOUR OWN



Shown with: Boat Top, Small Roundover Edge, and Hungary Base

STEP 1 | CHOOSE SIZE

Note: Ball Bearing Slides - Standard.

- 42" w x 72" l solid top SAT4272-S
- 42" w x 72" l four 12" leaves SAT4272-4
- 42" w x 72" l one 32" stationary butterfly leaf SAT4272-BF
- 42" w x 72" l 18" stationary butterfly leaf on each end SAT4272-Q*
- Available with up to two self-storing leaves with no aprons.....SA02SS.
- 42" w x 80" l solid top SAT4280-S
- 42" w x 80" l four 12" leaves SAT4280-4
- 42" w x 80" l one 32" stationary butterfly leaf SAT4280-BF
- 42" w x 80" l 18" stationary butterfly leaf on each end SAT4280-Q*
- Available with up to two self-storing leaves with no aprons.....SA02SS.
- 42" w x 96" l solid top SAT4296-S
- 42" w x 96" l four 12" leaves with aprons SAT4296-4
- 42" w x 96" l one 32" stationary butterfly leaf SAT4296-BF
- 42" w x 96" l 18" stationary butterfly leaf on each end SAT4296-Q*
- Available with up to two self-storing leaves with no aprons.....SA02SS.

- 48" w x 72" l solid top SAT4872-S
- 48" w x 72" l four 12" leaves SAT4872-4
- 48" w x 72" l one 32" stationary butterfly leaf SAT4872-BF
- 48" w x 72" l 18" stationary butterfly leaf on each end SAT4872-Q*
- Available with two self-storing leaves with no aprons.....SA02SS
- Available with four self-storing leaves with no aprons.....SA04SS
- 48" w x 80" l solid top SAT4880-S
- 48" w x 80" l four 12" leaves SAT4880-4
- 48" w x 80" l one 32" stationary butterfly leaf SAT4880-BF
- 48" w x 80" l 18" stationary butterfly leaf on each end SAT4880-Q*
- Available with two self-storing leaves with no aprons.....SA02SS
- Available with four self-storing leaves with no aprons.....SA04SS
- 48" w x 96" l solid top SAT4896-S
- 48" w x 96" l four 12" leaves with aprons SAT4896-4
- 48" w x 96" l one 32" stationary butterfly leaf SAT4896-BF
- 48" w x 96" l 18" stationary butterfly leaf on each end SAT4896-Q*
- Available with two self-storing leaves with no aprons.....SA02SS
- Available with four self-storing leaves with no aprons.....SA04SS

*Only Available on Rectangle Top with Square Corner and SATE-40 or 80 edge.

TABLE TOPS ARE 1" THICK. ALSO AVAILABLE IN 1 1/2" THICK. BUTTERFLY LEAVES NOT AVAILABLE ON 1 1/2" THICK TOPS

STEP 2 | CHOOSE SHAPE

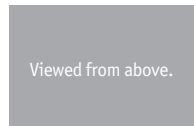

Square Corner SY0-SQ

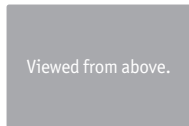

1" Radius Corner SY0-R1

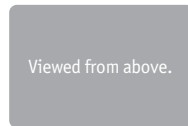

3" Radius Corner SY0-R3

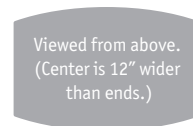

Boat SY0-B0 Butterfly leaf only available on 48" boat tops.

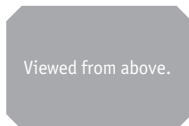

Clipped Corners SY0-CL

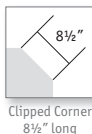

Empire SY0-EM

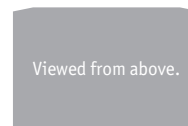

Shaker Hill SY0-SH

STEP 3 | CHOOSE EDGE



Large Roundover SATE-10



Underside Bevel SATE-20



Small Bevel SATE-30

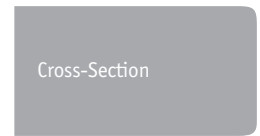

Small Roundover SATE-40



Lipped SATE-50



Large Bevel SATE-60



Queen Anne SATE-70

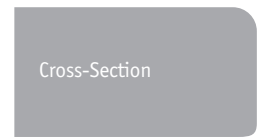

Medium Roundover SATE-80

NEW – 4" EDGE PROFILE OPTION SY0-4EP

Only Available on Solid Top or Butterfly End Leaves with Square Corners.



Valhalla table shown in Soft Maple, #60 Cloudy Bay, Olde World Aging - Level A, 20° Sheen

STEP 4 | CHOOSE TRESTLE BASE (CONTINUED ON NEXT PAGE)



a



b

Space Between Legs: 72" & 80" Table—45"; 96" Table—67"

a Adeline

- table height SAT-AD30
- counter height SAT-AD36

b Arnold

- table height SAT-AR30
- counter height SAT-AR36



c Alexandria

table height SAT-AX30
 counter height SAT-AX36

e Craftsman

Table Height SAT-CF30
 Counter Height SAT-CF36

g Hampton

table height SAT-HP30
 counter height SAT-HP36

i Mission

table height SAT-MI30
 counter height SAT-MI36

d Brookfield II

table height SAT-B230
 counter height SAT-B236

f Charleston

table height SAT-CH30
 counter height SAT-CH36

h Hungary

table height SAT-HN30
 counter height SAT-HN36

j Parkdale

table height SAT-PD30
 counter height SAT-PD36



k



l



m



n



o



p



q



r

Space Between Legs: 72" & 80" Table—45"; 96" Table—67"

k Reedsport

<input type="checkbox"/>	Table Height	SAT-RE30
<input type="checkbox"/>	Counter Height	SAT-RE36

m Shenandoah

<input type="checkbox"/>	table height	SAT-SN30
<input type="checkbox"/>	counter height	SAT-SN36

o Thomas

<input type="checkbox"/>	table height	SAT-TH30
<input type="checkbox"/>	counter height	SAT-TH36

q Victorian

<input type="checkbox"/>	table height	SAT-VC30
<input type="checkbox"/>	counter height	SAT-VC36

l Shaker Hill

<input type="checkbox"/>	Table Height	SAT-SH30
<input type="checkbox"/>	Counter Height	SAT-SH36

n Spain

<input type="checkbox"/>	table height	SAT-SP30
<input type="checkbox"/>	counter height	SAT-SP36

p Valhalla

<input type="checkbox"/>	table height	SAT-VA30
<input type="checkbox"/>	counter height	SAT-VA36

r Wildwood

<input type="checkbox"/>	table height	SAT-WW30
<input type="checkbox"/>	counter height	SAT-WW36

TRESTLE II TABLES

STYLE YOUR OWN



Shown with: Boat Top, Small Roundover Edge, and Hungary Base

STEP 1 | CHOOSE SIZE

Note: Ball Bearing Slides - Standard.

- 36" w x 48" l solid topSACT3648-S
- 36" w x 48" l two 12" leavesSACT3648-2
- 36" w x 72" l solid topSACT3672-S
- 36" w x 72" l two 12" leavesSACT3672-2
- 36" w x 72" l four 12" leavesSACT3672-4

Available with two self-storing leaves with no apronsSA02SS

- 38" w x 54" l solid topSACT3854-S
- 38" w x 54" l two 12" leavesSACT3854-2

Available with two self-storing leaves with no apronsSA02SS

- 38" w x 60" l solid topSACT3860-S
- 38" w x 60" l two 12" leavesSACT3860-2
- 38" w x 60" l four 12" leavesSACT3860-4
- 38" w x 60" l 18" stationary butterfly leaf on each endSACT3860-Q*

Available with two self-storing leaves with no apronsSA02SS

- 38" w x 72" l solid topSACT3872-S
- 38" w x 72" l two 12" leavesSACT3872-2
- 38" w x 72" l four 12" leavesSACT3872-4
- 38" w x 72" l 18" stationary butterfly leaf on each endSACT3872-Q*

Available with two self-storing leaves with no apronsSA02SS

- 42" w x 60" l solid topSACT4260-S
- 42" w x 60" l two 12" leavesSACT4260-2
- 42" w x 60" l four 12" leavesSACT4260-4
- 42" w x 60" l 18" stationary butterfly leaf on each endSACT4260-Q*

Available with two self-storing leaves with no apronsSA02SS

- 42" w x 72" l solid topSACT4272-S
- 42" w x 72" l two 12" leavesSACT4272-2
- 42" w x 72" l four 12" leavesSACT4272-4
- 42" w x 72" l one 32" stationary butterfly leafSACT4272-BF
- 42" w x 72" l 18" stationary butterfly leaf on each endSACT4272-Q*

Available with two self-storing leaves with no apronsSA02SS

- 42" w x 84" l solid topSACT4284-S
- 42" w x 84" l two 12" leaves with apronsSACT4284-2
- 42" w x 84" l four 12" leaves with apronsSACT4284-4
- 42" w x 84" l one 32" stationary butterfly leafSACT4284-BF
- 42" w x 84" l 18" stationary butterfly leaf on each endSACT4284-Q*

Available with two self-storing leaves with no apronsSA02SS

- 42" w x 96" l solid topSACT4296-S
- 42" w x 96" l two 12" leaves with apronsSACT4296-2
- 42" w x 96" l four 12" leaves with apronsSACT4296-4
- 42" w x 96" l one 32" stationary butterfly leafSACT4296-BF
- 42" w x 96" l 18" stationary butterfly leaf on each endSACT4296-Q*

Available with two self-storing leaves with no apronsSA02SS

- 48" w x 60" l solid topSACT4860-S
- 48" w x 60" l two 12" leavesSACT4860-2
- 48" w x 60" l four 12" leavesSACT4860-4
- 48" w x 60" l 18" stationary butterfly leaf on each endSACT4860-Q*

Available with two self-storing leaves with no apronsSA02SS

- 48" w x 72" l solid topSACT4872-S

*Only Available on Rectangle Top with Square Corner and edge SATE-40 or 80

TABLE TOPS ARE 1" THICK; ALSO AVAILABLE IN 1 1/2" THICK. BUTTERFLY LEAVES NOT AVAILABLE ON 1 1/2" THICK TOPS. APRONS 2 1/2"H

Space Between Legs: 48" & 54" Table—24"; 60" Table—32"; 72" Table—44"; 84" Table—44"; 96" Table—56"

STEP 1 CHOOSE SIZE

- 48" w x 72" l two 12" leavesSACT4872-2
- 48" w x 72" l four 12" leavesSACT4872-4
- 48" w x 72" l one 32" stationary butterfly leafSACT4872-BF
- 48" w x 72" l 18" stationary butterfly leaf on each endSACT4872-Q*

Available with two self-storing leaves with no apronsSA02SS
 Available with four self-storing leaves with no aprons.....SA04SS

- 48" w x 84" l solid topSACT4884-S
- 48" w x 84" l two 12" leaves with apronsSACT4884-2
- 48" w x 84" l four 12" leaves with apronsSACT4884-4
- 48" w x 84" l one 32" stationary butterfly leafSACT4884-BF
- 48" w x 84" l 18" stationary butterfly leaf on each endSACT4884-Q*

Available with two self-storing leaves with no apronsSA02SS
 Available with four self-storing leaves with no aprons.....SA04SS

- 48" w x 96" l solid topSACT4896-S
- 48" w x 96" l two 12" leaves with apronsSACT4896-2
- 48" w x 96" l four 12" leaves with apronsSACT4896-4
- 48" w x 96" l one 32" stationary butterfly leafSACT4896-BF
- 48" w x 96" l 18" stationary butterfly leaf on each endSACT4896-Q*

Available with two self-storing leaves with no apronsSA02SS
 Available with four self-storing leaves with no aprons.....SA04SS

*Only Available on Rectangle Top with Square Corner and edge SATE-40 or 80

STEP 2 CHOOSE SHAPE

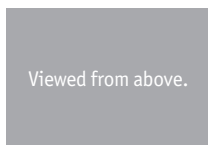

Square Corner SY0-SQ

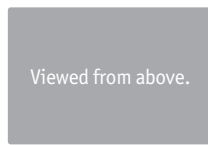

1" Radius Corner SY0-R1

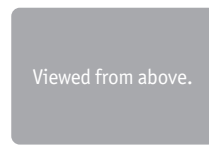

3" Radius Corner SY0-R3

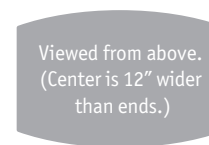

Boat SY0-B0
 (Butterfly leaf only available on 48" boat tops)

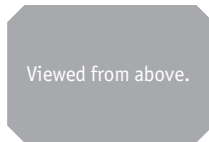

Clipped Corners SY0-CL

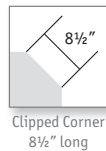

Clipped Corner
 8 1/2" long

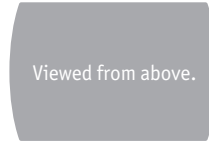

Empire SY0-EM

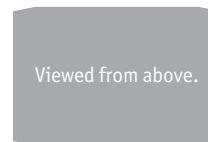

Shaker Hill SY0-SH

STEP 3 CHOOSE EDGE



Large Roundover SATE-10



Underside Bevel SATE-20

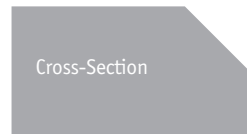

Small Bevel SATE-30

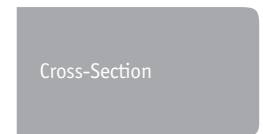

Small Roundover SATE-40



Lipped SATE-50



Large Bevel SATE-60



Queen Anne SATE-70

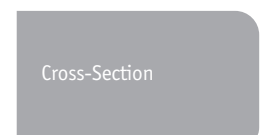

Medium Roundover SATE-80



a



b



c



d

Space Between Legs: 48" & 54" Table—24"; 60" Table—32"; 72" Table—44"; 84" Table—44"; 96" Table—56"

a Avalon

table height SACT-AVA30
 counter height SACT-AVA36

b Brecklyn

table height SACT-BRK30
 counter height SACT-BRK36

c Loft

table height SACT-LOF30
 counter height SACT-LOF36

d Louisville

table height SACT-LVL30
 counter height SACT-LVL36



e



f



g

e Shenandoah

- table height SACT-SHS30
- counter height SACT-SHS36

f Tremont

- table height SACT-TRE30
- counter height SACT-TRE36

g Will

- table height SACT-WLL30
- counter height SACT-WLL36

STORAGE

EAT



M. Miller

SHOWN IN QUARTERSAWN WHITE OAK-BOURBON



a Loft Minibar
 36" w x 25" d x 43" h
 LSLFT-C02C
 Opens to 72" w, 63 3/4" h
 Features 3 adjustable, reversible shelves for wine bottles on one side or flip them over for storing other items on the flat surfaces, an extra-large

drawer on the bottom, wine glass hangers at the top of the door opening, a hinged top that doubles the serving capacity of the top surface, and a hidden storage compartment with a quiet electric lift that opens by remote control or by the switch installed in the side of the cabinet. Big stuff in a small space.



a



b



c



d



e



f



g

a Aries Credenza, 60"
Black Base
60" w x 18" d x 36" h ESARI-31C-B

b Aspen Open Sideboard with Inlay
54" w x 18" d x 38" h ECASBD
Features open space behind doors.

c Aspen Open Sideboard Wine Rack with Inlay
54" w x 18" d x 38" h ECASBW
Features open space behind doors.

d Auburn Bay Buffet
60" w x 18 3/4" d x 36" h ESABR-G16C
72" w x 18 3/4" d x 36" h ESABR-G16D
Features one shelf on each side.

e Auburn Bay Credenza
60" w x 16" d x 36" h ESABR-H23C
72" w x 16" d x 36" h ESABR-H23D
Features two shelves on each side.

f B&O Railroad® Trestle Bridge Buffet
64" w x 19" d x 40 1/4" h ESTRB-G27C

g B&O Railroad® Trestle Bridge Sideboard 
60" w x 19" d x 36 1/2" h ESTRB-D11



a



b



c



d



e



f

a Brookfield Open Sideboard

66" w x 19 3/4" d x 46 1/4" h, Top: 40" h MEBIISB

Features a secret drawer under top center and inlaid monogram (specify letter).

Additional Options:

SmartTouch™ drawers with no hardware

b Crawford Buffet

60" w x 18" d x 36" h

ESCRA-G16C

72" w x 18" d x 36" h

ESCRA-G16D

Features one adjustable shelf on each side.

c Crawford Buffet with Legs

60" w x 18" d x 36" h

ESCRA-G28C

72" w x 18" d x 36" h

ESCRA-G28D

Features one adjustable shelf on each side.

d Crawford Credenza

60" w x 15" d x 36" h

ESCRA-H23C

72" w x 15" d x 36" h

ESCRA-H23D

Features two adjustable shelves on each side.

e Crawford Credenza with Legs

60" w x 15" d x 36" h

ESCRA-H28C

72" w x 15" d x 36" h

ESCRA-H28D

Features two adjustable shelves on each side.

f East Village Sideboard

62" w x 20" d x 46 1/4" h, Top: 40" h

TSEV60SB

Features two adjustable shelves on each side.

Door area: 14" w x 17" d x 26 1/4" h



a



b



c



d



e



f

a Grant 4-Drawer Sideboard

60" w x 19" d x 46 1/4" h, Top: 40" h TSGSB

Features two adjustable shelves on each side.

Door area: 17 3/4" w x 16 1/2" d x 32" h

b Grant Open Sideboard

51" w x 16" d x 38" h TVGSB

Features open space behind doors.

c Hamptons Buffet

Features frosted glass doors and a shelf behind each door.

60" w x 18" d x 36" h

ESHAP-G27C

72" w x 18" d x 36" h

ESHAP-G27D

d Homestead Sideboard

61 1/2" w x 18 3/4" d x 46 1/4" h, Top: 40" h TSHS60SB

Features two adjustable shelves on each side.

Door area: 14" w x 17" d x 32 1/4" h

e Ironwood Buffet

60" w x 20" d x 32" h, Black Base

ESIRN-G27C-B

Gunmetal Base

ESIRN-G27C-C

72" w x 20" d x 32" h, Black Base

ESIRN-G27D-B

Gunmetal Base

ESIRN-G27D-C

Features two adjustable shelves on each side; push-to-open doors.

f Ironwood Credenza

60" w x 18" d x 30" h, Black Base

ESIRN-H27C-B

Gunmetal Base

ESIRN-H27C-C

72" w x 18" d x 30" h, Black Base

ESIRN-H27D-B

Gunmetal Base

ESIRN-H27D-C

Features two adjustable shelves on each side; 1 adjustable shelf in the center; push-to-open doors.



a

b

c



d



e



f



g

a Justine Open Sideboard

51" w x 16" d x 37" h TVJSB
Features open space behind doors.

b Loft II Sideboard

62" w x 19" d x 46 3/4" h, Top: 40" h TSLII60SB
Features two adjustable shelves on each side
Door area: 14" w x 17" d x 25 1/4" h

c Louis Philippe Sideboard

62" w x 20" d x 40" h TSLP60SB
Features two shelves in each door area and two secret drawers below top.

d MäRyan Sideboard

71" w x 22" d x 40 3/4" h NWMRSB
Features three secret drawers and two adjustable shelves behind doors.

e Montauk Buffet

Rough Sawn & Plank Top Standard
60" w x 18 3/4" d x 36" h ESMOK-G27C
72" w x 18 3/4" d x 36" h ESMOK-G27D
Features two adjustable shelves on each side.

f Montauk Credenza

Rough Sawn & Plank Top Standard
60" w x 15 3/4" d x 36" h ESMOK-G23C
72" w x 15 3/4" d x 36" h ESMOK-G23D
Features two adjustable shelves on each side.

g Montgomery Buffet

71 1/2" w x 19" d x 37 1/2" h ESMTG-G16D
Features shelf behind each door.



a



b



c



d



e



f

a Parkdale Buffet

60" w x 17½" d x 36¼" h

ESPAR-G11C

72" w x 17½" d x 36¼" h

ESPAR-G11D

Features two adjustable shelves on each side.

b Parkdale Credenza

60" w x 17½" d x 36" h

ESPAR-H23C

72" w x 17½" d x 36" h

ESPAR-H23D

Features two adjustable shelves on each side.

c Prairie Mission Sideboard

61½" w x 18¾" d x 46¼" h, Top: 40" h

TSPM60SB

Features two adjustable shelves behind each door.

14" w x 17" d x 23" h

d Prairie Mission Open Sideboard

51" w x 16" d x 37" h

TV255SB

Features open space behind doors.

e Riverview Buffet

64" w x 19" d x 36" h

ESRIE-G11C

72" w x 19" d x 36" h

ESRIE-G11D

Features two adjustable shelves on each side.

f Riverview Credenza

64" w x 17" d x 36" h

ESRIE-H23C

72" w x 17" d x 36" h

ESRIE-H23D

Features two adjustable shelves on each side.



a



b



c



d



e

a Savannah Server

54½" w x 20¼" d x 38" h TSSS

Features storage for 20 bottles of wine, and a pullout on each side for increased surface area.

b Shaker Hill Open Sideboard

48" w x 16" d x 38" h MASH125SB

Features open space behind doors.

c Shaker Leg Sideboard

61¼" w x 19" d x 46¼" h, Top: 40" h TSSL60SB

Features two adjustable shelves behind each door: 14" w x 17" d x 26¼" h

d Shaker Open Sideboard

51" w x 16" d x 36¼" h LC56SBF

Features open space behind doors.

e Sheffield 2-Door Sideboard

46" w x 18" d x 37½" h ESSHE-D18

Features one adjustable shelf on each side.



a



b



c



d



e

a Shenandoah 2-Door Sideboard 

46" w x 18" d x 36½" h ESSHS-D18

Features one adjustable full-width shelf behind doors.

b Shenandoah 3-Door Sideboard 

54" w x 18" d x 36½" h ESSHS-D17

Features one adjustable full-width shelf behind doors.

c Sophia Sideboard

61½" w x 20¾" d x 46¼" h, Top: 40" h MESOSB

Features two shelves in each door area and push-to-open doors, hinged next to drawers.

d Wildwood Buffet

60" w x 20" d x 34" h ESWIL-G23C

72" w x 20" d x 34" h ESWIL-G23D

Features one hidden drawer and one shelf on each side.

e Wildwood Credenza

60" w x 16" d x 34" h ESWIL-H23C

72" w x 16" d x 34" h ESWIL-H23D

Features two shelves on each side.



EXPRESS



QUICKSHIP

simplyamish



a



b



c



d



e



f



g

a Country Double Door Cabinet

39¾" w x 12¾" d x 40¾" h ME393PSR

Features two adjustable shelves and raised-panel fronts.

b Country 2-Drawer Cabinet

39¾" w x 16" d x 40¾" h ME405APSR

Features one adjustable shelf and raised-panel fronts.

c Country 1-Drawer Cabinet

39¾" w x 16" d x 40¾" h ME405PSR

Features one adjustable shelf and raised-panel fronts.

d Country Jamie Cabinet

43½" w x 16" d x 56¼" h ME416JPSR

Features two adjustable shelves and raised-panel fronts.

e Pantry Cabinet

42" w x 23¾" d x 72" h LC510C

Features four adjustable shelves.

f Prairie Mission 1-Drawer Cabinet

39¾" w x 16" d x 40¾" h LCPM405

Features one adjustable shelf.

g Prairie Mission Jamie Cabinet

43½" w x 16" d x 56¼" h LCPM416

Features two adjustable shelves.

Available with Beveled, Plain, Frosted, Water, or Antique Glass. **Note:** 3-Door Dining Cabinets feature four drawers. 2-Door Dining Cabinets feature two drawers.

Variety is the spice of life!

With five different styles of glass to choose from, your selection can dramatically impact the look and feel of your furniture.

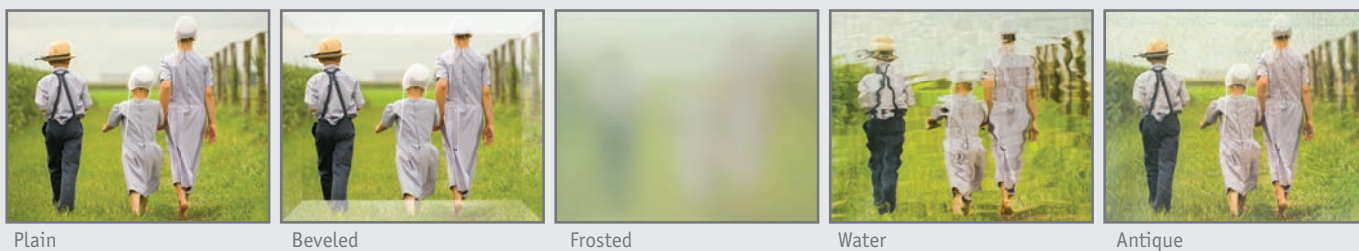

Plain

Beveled

Frosted

Water

Antique



a



b



c



d



e



f

EAT
STORAGE

a Aspen Dining Cabinet with Glass Doors and Inlay *

3-Door: 57" w x 20" d x 52" h ECADC3BG-
2-Door: 40½" w x 20" d x 52" h ECADC2G-

Features beveled glass doors, 2-LED light system, and adjustable glass shelf with plate groove.

Aspen Dining Cabinet with Wood Doors and Inlay

(Not shown)
3-Door: 57" w x 20" d x 52" h ECADC3W
2-Door: 40½" w x 20" d x 52" h ECADC2W

Features one adjustable wood shelf.

b B&O Railroad® Trestle Bridge 3-Door Dining Cabinet *

62" w x 20" d x 54" h ESTRB-E14-

Features plain glass doors, 2-LED light system, and adjustable glass shelf with plate groove.

c Classic Dining Cabinet with Glass Doors and Ends *

3-Door: 57½" w x 18½" d x 51" h SCDCL3G-
2-Door: 39½" w x 18½" d x 51" h SCDCL2G-

Features beveled glass doors, 2-LED light system, and adjustable glass shelf with plate groove.

Classic Dining Cabinet with Wood Doors and Ends

(Not shown)
3-Door: 57½" w x 18½" d x 51" h SCDCL3W
2-Door: 39½" w x 18½" d x 51" h SCDCL2W

Features one adjustable wood shelf.

d East Village Dining Cabinet with Glass Doors and Ends *

3-Door: 59" w x 19½" d x 51" h SCDCEV3G-
2-Door: 42" w x 19½" d x 51" h SCDCEV2G-

Features plain glass doors, 2-LED light system, and adjustable glass shelf with plate groove.

East Village Dining Cabinet with Wood Doors and Ends

(Not shown)
3-Door: 59" w x 19½" d x 51" h SCDCEV3W
2-Door: 42" w x 19½" d x 51" h SCDCEV2W

Features one adjustable wood shelf.

e Justine Dining Cabinet with Glass Doors and Ends *

3-Door: 57" w x 18½" d x 51" h SDCJS3G-
2-Door: 39½" w x 18½" d x 51¼" h SDCJS2G-

Features 2-LED light system, plain glass doors and adjustable glass shelf with plate groove.

Justine Dining Cabinet with Wood Doors (Not Shown)

3-Door: 57" w x 18½" d x 51" h SDCJS3W
2-Door: 39½" w x 18½" d x 51¼" h SDCJS2W

Features one adjustable wood shelf.

f Loft Dining Cabinet with Glass Doors and Ends *

3-Door: 57½" w x 18½" d x 51" h SCDCL03G-
2-Door: 40½" w x 18½" d x 51" h SCDCL02G-

Features 2-LED light system, plain glass doors and adjustable glass shelf with plate groove.

Loft Dining Cabinet with Wood Doors and Ends

(Not Shown)
3-Door: 57½" w x 18½" d x 51" h SCDCL03W
2-Door: 40½" w x 18½" d x 51" h SCDCL02W

Features one adjustable wood shelf.



LED LIGHT SYSTEM
Indicates Built In

* Available with Beveled, Plain, Frosted, Water, or Antique Glass. **Note:** 3-Door Dining Cabinets feature four drawers. 2-Door Dining Cabinets feature two drawers.

Variety is the spice of life!

With five different styles of glass to choose from, your selection can dramatically impact the look and feel of your furniture.



Plain



Beveled



Frosted



Water



Antique



a



b



c



d

a MäRyan 3-Door Dining Cabinet with Glass Doors *

63½" w x 22" d x 55¼" h NWDCM3G-🍃

Features plain glass doors, 2-LED light system, two secret drawers, and adjustable glass shelf with plate groove.

b McCoy Dining Cabinet with Glass Doors *

3-Doors: 57¾" w x 20½" d x 51¼" h SCDCMC3G-🍃*

2-Doors: 41" w x 20½" d x 51¼" h SCDCMC2G-🍃*

Features 2-LED light system, beveled glass doors and adjustable glass shelf with plate groove.

McCoy Dining Cabinet with Wood Doors (Not Shown)

3-Doors: 57¾" w x 20½" d x 51¼" h SCDCMC3W

2-Doors: 41" w x 20½" d x 51¼" h SCDCMC2W

Features one adjustable wood shelf.

c McCoy Server with Antique Glass Doors

40" w x 20" d x 38¼" h WSMCSP

Features one adjustable shelf.

d Prairie Mission Dining Cabinet with Glass Doors and Ends *

3-Doors: 57" w x 19½" d x 51" h SCDCPM3G-🍃*

2-Doors: 39" w x 19½" d x 51" h SCDCPM2G-🍃*

Features 2-LED light system, plain glass mullion doors and adjustable glass shelf with plate groove.

Prairie Mission Dining Cabinet with Wood Doors and Ends (Not Shown)

3-Doors: 57" w x 19½" d x 51" h SCDCPM3W

2-Doors: 39" w x 19½" d x 51" h SCDCPM2W

Features one adjustable wood shelf.

🍃 Available with Beveled, Plain, Frosted, Water, or Antique Glass. *Not available with Beveled Glass. **Note:** 3-Door Dining Cabinets feature four drawers. 2-Door Dining Cabinets feature two drawers.



a



b



c



d



e



f

a Aspen Closed Hutch with Inlay, 45½"

Top: 45½" w x 17" d x 45¾" h ESASP-J06
 19" Base: 45½" w x 19" d x 34⅞" h ESASP-A02B
 22" Base: 45½" w x 22" d x 34⅞" h ESASP-C02B

Top features two adjustable glass shelves with plate grooves. Base features one adjustable shelf behind doors.

b Aspen Closed Hutch with Inlay, 64½"

Top: 64½" w x 17" d x 45¾" h ESASP-K06
 19" Base: 64½" w x 19" d x 34⅞" h ESASP-A03E
 22" Base: 64½" w x 22" d x 34⅞" h ESASP-C03E

Top features two adjustable glass shelves with plate grooves. Base features one adjustable shelf behind doors.

c Aspen Closed Hutch with Inlay, 84½"

Top: 84½" w x 17" d x 45¾" h ESASP-L06
 19" Base: 84½" w x 19" d x 34⅞" h ESASP-A04B
 22" Base: 84½" w x 22" d x 34⅞" h ESASP-C04B

Top features two adjustable glass shelves with plate grooves. Base features one adjustable shelf behind doors.

d Aspen Open Hutch with Inlay, 64½"

Top: 64½" w x 17" d x 45¾" h ESASP-K07
 19" Base: 64½" w x 19" d x 34⅞" h ESASP-A03E
 22" Base: 64½" w x 22" d x 34⅞" h ESASP-C03E

Top features one adjustable glass shelf with plate grooves. Base features one adjustable shelf behind doors.

e Aspen Closed Corner Hutch with Inlay

Top: 38" (each side) x 46⅞" h ESASP-S02
 Base: 37" (each side) x 34⅞" h ESASP-B02A

Top features two adjustable glass shelves with plate grooves. Base features one adjustable shelf behind doors, center drawer and two faux drawer fronts.

f Aspen 2-Door Cabinet

36" w x 16" d x 32" h ESASP-J20E

Available with Beveled, Plain, Frosted, Water, or Antique Glass.



a

Arch de triomphe.

Crown your hutch with a graceful arch, creating additional vertical impact and a focal point for your room.

Arch top, KCOAT



You can't go wrong with the classics.

Especially when it's so easy to customize your selection with options like beautiful raised-panel ends.



b



c

a B&O Railroad® Trestle Bridge Closed Hutch

Top: 64" w x 16" d x 46" h ESTRB-K06
 Base: 64" w x 19" d x 39½" h ESTRB-A03A

Features two adjustable shelves on each side.

b Classic Closed Hutch, 75½"

Top: 75½" w x 15¾" d x 45¾" h ESCLA-L06
 18" Base: 73½" w x 18¾" d x 34" h ESCLA-A04B
 22" Base: 73½" w x 21¾" d x 34" h ESCLA-C04B

Features one adjustable shelf in base.

c Classic Closed Hutch, 63½"

Top: 63½" w x 15¾" d x 45¾" h ESCLA-K06
 18" Base: 61½" w x 18¾" d x 34" h ESCLA-A03B
 22" Base: 61½" w x 21¾" d x 34" h ESCLA-C03B

Features one adjustable shelf in base.

Available with Beveled, Plain, Frosted, Water, or Antique Glass.

Shown with optional open ends on top



a



b



c



d



e

a Classic Open Hutch, 76"

Top: 76" w x 16 1/2" d x 47" h ESCLA-L07
 18" Base: 73 1/2" w x 18 3/4" d x 34" h ESCLA-A04B
 22" Base: 73 1/2" w x 21 3/4" d x 34" h ESCLA-C04B
 Features one adjustable shelf in base.

b Classic Open Hutch, 63 1/2"

Top: 63 1/2" w x 15 3/4" d x 45 3/4" h ESCLA-K07
 18" Base: 61 1/2" w x 18 3/4" d x 34" h ESCLA-A03B
 22" Base: 61 1/2" w x 21 3/4" d x 34" h ESCLA-C03B
 Features one adjustable shelf in base.

c Classic Closed Corner Hutch, 33 3/4"

Top: 34 3/4" (each side) x 45 3/4" h ESCLA-S02
 Base: 33 3/4" (each side) x 34" h ESCLA-B02A
 Features center drawer and two faux drawer fronts and one adjustable shelf in base.

d Classic Closed Corner Hutch, 22 3/4"

Top: 23 3/4" (each side) x 45 3/4" h ESCLA-S01
 Base: 22 3/4" (each side) x 34" h ESCLA-B01B
 Features faux drawer front and one adjustable shelf in base.

e Classic Hutch Base, 61 1/2"

18" Base: 61 1/2" w x 18 3/4" d x 34" h ESCLA-A03B
 22" Base: 61 1/2" w x 21 3/4" d x 34" h ESCLA-C03B
 Shown with stack of drawers option KCOSDB
 Features one adjustable shelf behind doors in base.

Available with Beveled, Plain, Frosted, Water, or Antique Glass.



a



b



c



d

a East Village Open Hutch, 43 1/2"

Top: 43 1/2" w x 15 3/4" d x 46 1/4" h

Base: 43 1/2" w x 19 1/2" d x 34" h

ESESV-J07

ESESV-C02B

Top features one adjustable glass shelf. Base features one adjustable shelf behind doors.

b East Village Open Hutch, 62"

Top: 62" w x 15 3/4" d x 46 1/4" h

Base: 62" w x 19 1/2" d x 34" h

ESESV-K07

ESESV-C03A

Top features one adjustable glass shelf. Center panel comes as a fixed, non-working door. Base features one adjustable shelf behind doors.

c Justine Closed Hutch, 60 3/4" *

Top: 60 3/4" w x 15" d x 46 1/2" h

Base: 60 3/4" w x 19" d x 34 1/2" h

ESJUS-K02

ESJUS-A03E

Top features 3-LED light system, and glass shelves with plate grooves. Base features one adjustable shelf behind doors.

d Loft Open Hutch, 58"

Top: 60" w x 15" d x 47 1/4" h

Base: 58" w x 18 1/2" d x 34 1/2" h

ESLFT-K07

ESLFT-A03A

Top features one adjustable glass shelf. Center panel comes as a fixed, non-working door. Base features one adjustable shelf behind doors.

Available with Beveled, Plain, Frosted, Water, or Antique Glass.



a



b



c



d

a MärRyan Closed Hutch, 81¼" *

Top: 81¼"w x 18"d x 48"h

ESMRY-L06

Base: 81¼"w x 25"d x 36"h

ESMRY-C04A

Top features two adjustable glass shelves in top and 3-LED light system. Base features one adjustable shelf behind doors.

b McCoy Open Hutch, 60" *

Top: 56"w x 16¼"d x 46¾"h

ESMCC-K07

Base: 60"w x 20"d x 34"h

ESMCC-C03B

McCoy Open Hutch, 76" * (Not Shown):

Top: 72"w x 16¼"d x 46¾"h

ESMCC-L07

Base: 76"w x 20"d x 34"h

ESMCC-C04B

Top features glass shelf with plate grooves, 3-LED light system. Base features one fixed shelf behind doors in base.

c Prairie Mission Closed Hutch, 42"

Top: 44"w x 15¾"d x 46"h

ESPMS-J13 *

18" Base: 42"w x 19½"d x 34"h

ESPMS-A02B

22" Base: 42"w x 22½"d x 34"h

ESPMS-C02B

Features one adjustable shelf behind doors in base.

d Prairie Mission Closed Hutch, 61½"

Top: 63½"w x 15¾"d x 46"h

ESPMS-K13 *

18" Base: 61½"w x 19½"d x 34"h

ESPMS-A03B

22" Base: 61½"w x 22½"d x 34"h

ESPMS-C03B

Features glass ends, mullion doors, adjustable glass shelves in top with plate grooves and adjustable shelf behind doors in base.

Prairie Mission Closed Hutch, 73½"

(Not Shown)

Top: 75½"w x 15¾"d x 46"h

ESPMS-L13 *

18" Base: 73½"w x 19½"d x 34"h

ESPMS-A04B

22" Base: 73½"w x 22½"d x 34"h

ESPMS-C04B

Features glass ends, mullion doors, adjustable glass shelves in top with plate grooves and adjustable shelf behind doors in base.

Available with Beveled, Plain, Frosted, Water, or Antique Glass. *Not available with Beveled Glass.



LED LIGHT SYSTEM
Indicates Built In

simplyamish



a



b



c



d

a Savannah Closed Hutch, 45 1/2"

Top: 45 3/4" w x 16 5/8" d x 45 3/4" h ESSAV-J12 *
 Base: 45 1/2" w x 23" d x 34" h ESSAV-C02B

Features mullion doors, two adjustable glass shelves with plate grooves in top and one adjustable shelf behind doors in base.

b Savannah Closed Hutch, 62"

Top: 65 3/4" w x 16 5/8" d x 45 3/4" h ESSAV-K12 *
 Base: 62" w x 23" d x 34" h ESSAV-C03F

Features mullion doors, two adjustable glass shelves with plate grooves in top and one adjustable shelf on each side of base.

c Shaker Closed Hutch, 42"

Top: 42" w x 14 3/4" d x 46 1/4" h ESSKR-J06
 18" Base: 42" w x 18 3/4" d x 34" h ESSKR-A02B
 22" Base: 42" w x 21 3/4" d x 34" h ESSKR-C02B

Features one adjustable shelf behind doors in base.

d Shaker Closed Hutch, 61 1/2"

Top: 61 1/2" w x 14 3/4" d x 46 1/4" h ESSKR-K06
 18" Base: 61 1/2" w x 18 3/4" d x 34" h ESSKR-A03B
 22" Base: 61 1/2" w x 21 3/4" d x 34" h ESSKR-C03B

Features one adjustable shelf behind doors in base.

Available with Beveled, Plain, Frosted, Water, or Antique Glass. *Not available with Beveled Glass.



a



b



c



d



e

a Shaker Closed Hutch, 73 1/2"

Top: 73 1/2" w x 14 3/4" d x 46 1/4" h
 18" Base: 73 1/2" w x 18 3/4" d x 34" h
 22" Base: 73 1/2" w x 21 3/4" d x 34" h

ESSKR-L06
 ESSKR-A04B
 ESSKR-C04B

Features one adjustable shelf behind doors in base.

b Shaker Hoosier Hutch, 61 1/2"

Right Top: 61 1/2" w x 14 3/4" d x 46 1/4" h
 Right 18" Base: 61 1/2" w x 18 3/4" d x 34" h
 Right 22" Base: 61 1/2" w x 21 3/4" d x 34" h

ESSKR-K09
 ESSKR-A03D
 ESSKR-C03D

(Not Shown)

Left Top: 61 1/2" w x 14 3/4" d x 46 1/4" h
 Left 18" Base: 61 1/2" w x 18 3/4" d x 34" h
 Left 22" Base: 61 1/2" w x 21 3/4" d x 34" h

ESSKR-K08
 ESSKR-A03C
 ESSKR-C03C

Features one adjustable shelf behind doors in base.

c Shaker Closed Corner Hutch, 22 3/4"

Top: 22 3/4" each side x 46 1/4" h
 Base: 22 3/4" each side x 34" h

ESSKR-S01
 ESSKR-B01B

Features faux drawer front and one adjustable shelf behind doors in base.

d Shaker Closed Corner Hutch, 33 3/4"

Top: 33 3/4" each side x 46 1/4" h
 Base: 33 3/4" each side x 34" h

ESSKR-S02
 ESSKR-B02A

Features center drawer, two faux drawer fronts and one adjustable shelf behind doors in base.

e Shenandoah Closed Hutch, 60 1/4"

Top: 60 1/4" w x 15 1/4" d x 46" h
 Base: 60 1/4" w x 18 3/4" d x 34 1/2" h

ESSHS-K06-
 ESSHS-C03B

Features two adjustable glass shelves with plate grooves in top and one adjustable shelf behind doors in base.

Available with Beveled, Plain, Frosted, Water, or Antique Glass.

INSET DINING CABINETS

STYLE YOUR OWN



Shown with: Top with $\frac{3}{4}$ " Overhang, Flat Panel Drawers and Doors, and 4" Plinth Base

STEP 1 | CHOOSE CASE

*Size does not include top and feet.

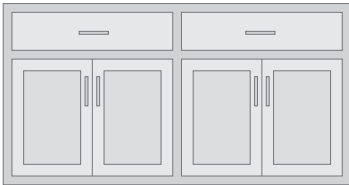

Inset Buffet, 60"
59½" w x 18"d x 31"h* ESG29C

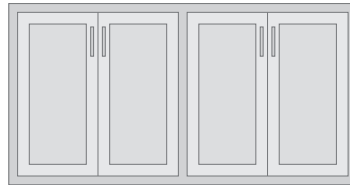

Inset Credenza, 60"
59½" w x 15"d x 31"h* ESH23C



4-Drawer Credenza, 60"
59½" w x 18"d x 31"h* ESG27C

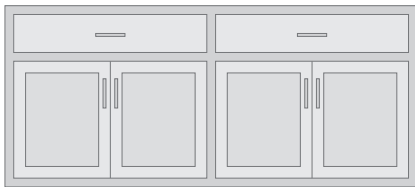

Inset Buffet, 70"
70½" w x 18"d x 31"h* ESG29D

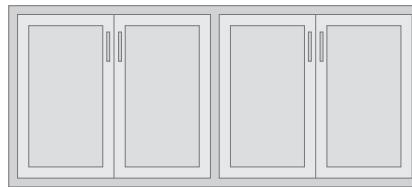

Inset Credenza, 70"
70½" w x 15"d x 31"h* ESH23D



4-Drawer Credenza, 70"
70½" w x 18"d x 31"h* ESG27D

STEP 2 | CHOOSE TOP



Top with Trim
EST-CH
Adds $\frac{3}{4}$ " to overall height.
Adds 2" to overall width.
Adds 1" to overall depth.

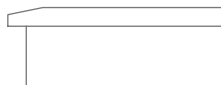

Top with Large Bevel
EST-LB
Adds $\frac{3}{4}$ " to overall height.
Adds 1½" to overall width.
Adds $\frac{3}{4}$ " to overall depth.

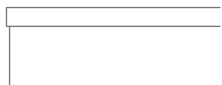

Top with $\frac{1}{8}$ " Overhang
EST-MO
Adds $\frac{3}{4}$ " to overall height.
Adds $\frac{1}{4}$ " to overall width.
Adds $\frac{1}{8}$ " to overall depth.

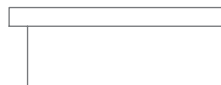

Top with $\frac{3}{4}$ " Overhang
EST-TR
Adds $\frac{3}{4}$ " to overall height.
Adds 1½" to overall width.
Adds $\frac{3}{4}$ " to overall depth.



Top with Reverse Bevel
EST-RB
Adds $\frac{3}{4}$ " to overall height.
Adds 2" to overall width.
Adds 1" to overall depth.

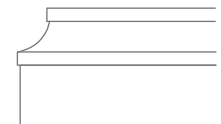

Cove Top
EST-CT
Adds 2½" to overall height.
Adds $\frac{1}{4}$ " to overall width.
Adds $\frac{1}{8}$ " to overall depth.

STEP 3 CHOOSE INSET DRAWER FRONT



Flat Slab
ESS-FS



Flat Panel
ESS-FP

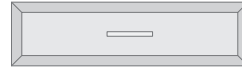

Raised Panel
ESS-RP



Applied Trim
ESS-RT



Beaded Edge
ESS-BE



Step Panel
ESS-SP



Scalloped Panel
ESS-SC

STEP 4 CHOOSE INSET DOOR FRONT

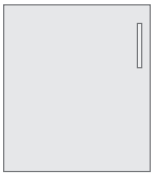

Flat Slab
Door Front
ESR-FS

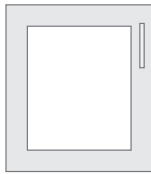

Glass
Door Front
ESR-G-

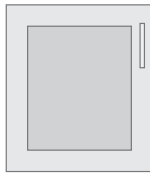

Flat Panel
Door Front
ESR-FP

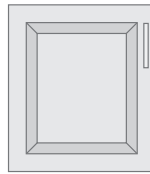

Raised Panel
Door Front
ESR-RP



Beaded Edge
Door Front
ESR-BE

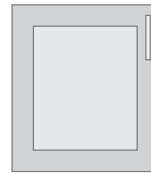

Step Panel
Door Front
ESR-SP

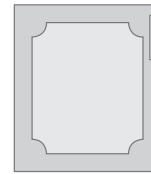

Scalloped Panel
Door Front
ESR-SC

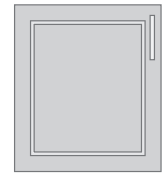

Applied Trim
Door Front
ESR-RT

STEP 5 CHOOSE LEG/BASE



4" Curved Leg
ESL-CH-4
Adds 4" to overall height.

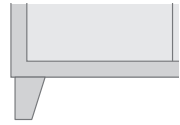

4" Tapered Leg
ESL-TR-4
Adds 4" to overall height.



4" Square Leg
ESL-MO-4
Adds 4" to overall height.

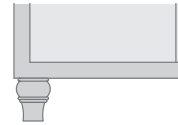

4" Turned Leg
ESL-TU-4
Adds 4" to overall height.



4" Plinth Base
ESL-PL-4
Adds 4" to overall height.

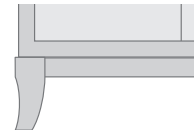

7" Curved Leg
ESL-CH-7
Adds 7" to overall height.

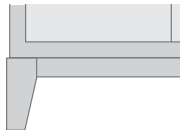

7" Tapered Leg
ESL-TR-7
Adds 7" to overall height.

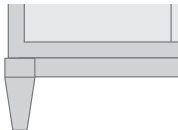

7" Round Tapered Leg
ESL-RD-7
Adds 7" to overall height.

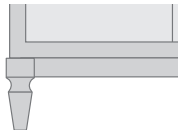

7" Beveled Leg
ESL-BV-7
Adds 7" to overall height.

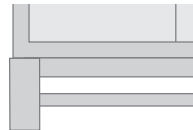

7" Crossbar Base
ESL-CB-7
Adds 7" to overall height.

STEP 6 CHOOSE HARDWARE Level A hardware is standard. See page 25 for complete selection.

Variety is the spice of life!

With five different styles of glass to choose from, your selection can dramatically impact the look and feel of your furniture.



Plain - GP



Beveled - GB



Frosted - GF



Water - GW



Antique - GA

FULL OVERLAY DINING CABINETS

STYLE YOUR OWN



Shown with: Top with $\frac{3}{4}$ " Overhang, Flat Slab Drawers and Doors, and Angled Leg Base

STEP 1 CHOOSE CASE

*Size does not include top and feet.



Full Overlay Center Buffet, 60"
59½" w x 18" d x 31" h* ESFUL-G29C



Full Overlay Center Buffet, 70"
70½" w x 18" d x 31" h* ESFUL-G29D

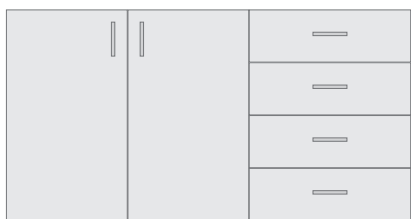

Full Overlay Offset Credenza, 60"
59½" w x 15" d x 31" h* ESFUL-G30C

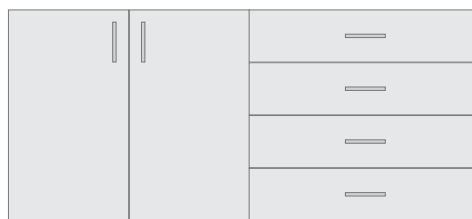

Full Overlay Offset Credenza, 70"
70½" w x 15" d x 31" h* ESFUL-G30D

STEP 2 CHOOSE TOP



Top with Large Bevel
EST-LB
Adds $\frac{3}{4}$ " to overall height.
Adds 1½" to overall width.
Adds $\frac{3}{4}$ " to overall depth.



Top with $\frac{1}{8}$ " Overhang
EST-MO
Adds $\frac{3}{4}$ " to overall height.
Adds $\frac{1}{4}$ " to overall width.
Adds $\frac{1}{8}$ " to overall depth.



Top with $\frac{3}{4}$ " Overhang
EST-TR
Adds $\frac{3}{4}$ " to overall height.
Adds 1½" to overall width.
Adds $\frac{3}{4}$ " to overall depth.



Top with Reverse Bevel
EST-RB
Adds $\frac{3}{4}$ " to overall height.
Adds 2" to overall width.
Adds 1" to overall depth.

STEP 3 CHOOSE FULL OVERLAY DRAWER FRONT



Flat Slab
ESS-FS



Flat Panel
ESS-FP

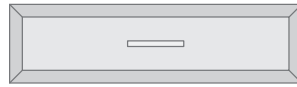

Raised Panel
ESS-RP



Applied Trim
ESS-RT



Beaded Edge
ESS-BE



Step Panel
ESS-SP



Scalloped Panel
ESS-SC

STEP 4 CHOOSE FULL OVERLAY DOOR FRONT

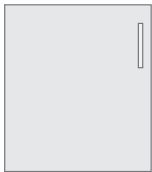

Flat Slab Door Front
ESR-FS

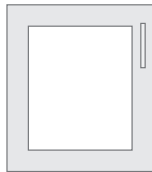

Glass Door Front
ESR-G-

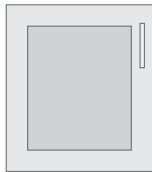

Flat Panel Door Front
ESR-FP

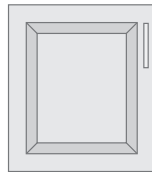

Raised Panel Door Front
ESR-RP



Beaded Edge Door Front
ESR-BE

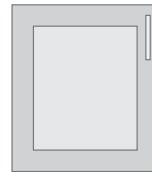

Step Panel Door Front
ESR-SP

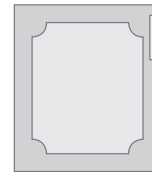

Scalloped Panel Door Front
ESR-SC

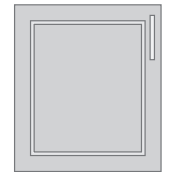

Applied Trim Door Front
ESR-RT

STEP 5 CHOOSE LEG/BASE



Angled Leg
ESFUL-L-AN, Adds 4" to overall height.



Cutout Base
ESFUL-L-CO, Adds 4" to overall height.



T-Base
ESFUL-L-TB, Adds 4" to overall height.

STEP 6 CHOOSE HARDWARE

Level A hardware is standard. See page 25 for complete selection.

Variety is the spice of life!

With five different styles of glass to choose from, your selection can dramatically impact the look and feel of your furniture.



Plain - GP



Beveled - GB

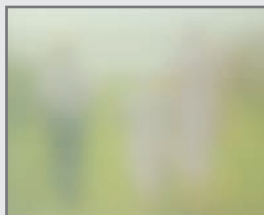

Frosted - GF



Water - GW



Antique - GA

CHAIRS

EAT



CAMPBELL SIDE CHAIRS SHOWN IN CHERRY, MICHAEL'S



a



b



a Allison Chair

Arm chair Arm Height: 25 $\frac{1}{4}$ "h
25 $\frac{3}{4}$ "w x 23 $\frac{3}{4}$ "d x 41"h SAANA-🍃

Side chair
19"w x 23 $\frac{3}{4}$ "d x 41"h SAANS-🍃

b Anissa Side Chair

19"w x 17"d x 32"h ECNSA-02A-🍃

🍃 Available with wood seat, fabric cushion seat or leather cushion seat. If using your own fabric please supply $\frac{1}{2}$ yard. COM = Grade 3.



a



b



c



d



a Arnold Chair

Arm Chair Arm Height: 25" h
24½" w x 22½" d x 42" h ECARN-01A

Side Chair
18½" w x 21½" d x 42" h ECARN-02A

b Aspen Chair with Inlay

Arm Chair Arm Height: 26" h
25¾" w x 21¼" d x 48½" h SAAA-

Side Chair
18½" w x 21¼" d x 48½" h SAAS-

c Aspen Chair with Lower Back and Inlay

Arm Chair Arm Height: 25¾" h
25¾" w x 21¼" d x 43½" h SAAA-5-

Side Chair
18½" w x 21¼" d x 43½" h SAAS-5-

d Avalon Hill Chair

Arm chair Arm Height: 25¾" h
21½" w x 23" d x 42" h SAAHA-

Side chair
19¼" x 23" x 42" h SAHS-

Available with wood seat, fabric cushion seat or leather cushion seat. If using your own fabric please supply ½ yard. COM = Grade 3.



a



b



c



d

a B&O Railroad® Trestle Bridge Chair



Arm Chair Arm Height: 24½" h
 24" w x 24½" d x 42" h ECTRB-01A

Side Chair
 21½" w x 24½" d x 42" h ECTRB-02A

b Bentback Chair

Arm chair Arm Height: 25" h
 25¼" w x 20" d x 41" h
 Turned Legs YMBBACT-W
 Plain Legs YMBBACP-W (shown)

Side chair
 18¾" w x 20" d x 41" h
 Turned Legs YMBBSCT-W (shown)
 Plain Legs YMBBSCP-W
 Not available in quartersawn white oak.

c Bradford Chair



Arm chair Arm Height: 25¼" h
 23¾" w x 23¾" d x 40" h ECBRD-01A-

Side chair
 19" w x 23¾" d x 40" h ECBRD-02A-

d Bradley Chair

Arm chair Arm Height: 25" h
 25" w x 18¾" d x 44½" h ECBRL-01A-

Side chair
 19½" w x 18" d x 44½" h ECBRL-02A-

Available with wood seat, fabric cushion seat or leather cushion seat. If using your own fabric please supply ½ yard. COM = Grade 3.



a



b



c



d



a Bristol Chair

Arm Chair	Arm Height: 25½" h	
22½" w x 19" d x 38½" h	SABA-	
Side chair		
20" w x 19" d x 38½" h	SABS-	

b Brookfield Chair

Arm chair	Arm Height: 24¾" h	
24¾" w x 16½" d x 40½" h	SABFA-	
Side chair		
19" w x 17" d x 40½" h	SABFS-	

c Cadira Chair

Arm chair	Arm Height: 25½" h	
24½" w x 21½" d x 34¾" h	ECCDI-01A-	
Side chair		
19" w x 21" d x 34¾" h	ECCDI-02A-	

d Campbell Chair

Arm chair	Arm Height: 25½" h	
23½" w x 21¼" d x 41" h	ECCAM-01A-	
Side Chair		
19" w x 21¼" d x 41" h	ECCAM-02A-	

Available with wood seat, fabric cushion seat or leather cushion seat. If using your own fabric please supply ½ yard. COM = Grade 3.



a Clifton Side Chair
 18" w x 21½" d x 39½" h ECCLI-02A-

b Concord Chair
 Arm chair Arm Height: 25¼" h
 22½" w x 18½" d x 35½" h SACOA-
 Side chair
 18½" w x 18½" d x 35½" h SACOS-

c Corbin Chair
 Arm Chair Arm Height: 25¼" h
 24" w x 21¾" d x 42" h ECCRB-01A
 Side Chair
 18½" w x 21¾" d x 42" h ECCRB-02A



d Crawford Side Chair
 18" w x 21½" d x 38¼" h ECCRA-02A-



e Esther Chair
 Arm Chair Arm Height: 25½" h
 23" w x 16½" d x 40" h ECEST-01A-W
 Side Chair
 20½" w x 16½" d x 40" h ECEST-02A-W
 Not available in Character Cherry, Hickory, QSWO, or Walnut.



Available with wood seat, fabric cushion seat or leather cushion seat. If using your own fabric please supply ½ yard. COM = Grade 3.



a Foldus Folding Chair
18½" w x 17" d x 32" h ECFOL-11A-W

b Franklin Chair 
 Arm chair Arm Height: 25" h
 25¼" w x 22½" d x 44½" h KAFCA- 
 Side chair
 19" w x 22" d x 44½" h KAFCS- 

c Grant Chair 
 Arm chair Arm Height: 25½" h
 24" w x 21" d x 42" h SAGRA- 
 Side chair
 18" w x 20" d x 42" h SAGRS- 

d Grant II Chair 
 Arm chair Arm Height: 25½" h
 23" w x 20" d x 38" h SAGRIA-4- 
 Side chair
 17¾" w x 19¾" d x 38" h SAGRIIS-4- 

 Available with wood seat, fabric cushion seat or leather cushion seat. If using your own fabric please supply ½ yard. COM = Grade 3.



a



b



c



d

a Hamptons Chair

Arm chair Arm Height: 25½”h
24¾”w x 22¾”d x 40”h ECHAP-01A-☞

Side chair
18”w x 22¾”d x 40”h ECHAP-02A-☞

b Hanna Chair

Arm chair Arm Height: 25”h
21½”w x 23¼”d x 40”h ECHAN-01A-☞

Side chair
18¾”w x 23¾”d x 40”h ECHAN-02A-☞

c Harlow Chair

Arm Chair Arm Height: 24½”h
24½”w x 22½”d x 40”h ECHLW-01A ☞

Side Chair
20½”w x 22½”d x 40”h ECHLW-02A ☞

d Hudson Chair

Arm chair Arm Height: 24½”h
25½”w x 19½”d x 42”h SAHUA-☞

Side chair
18”w x 19½”d x 42”h SAHUS-☞

☞ Available with wood seat, fabric cushion seat or leather cushion seat. If using your own fabric please supply ½ yard. COM = Grade 3.



a



b



c



d

a Jacob Chair

Arm Chair Arm Height: 25½" h
24" w x 22" d x 43¼" h ECJCB-01A-🍷
Side Chair
19½" w x 23" d x 43¼" h ECJCB-02A-🍷

b Joseph Chair

Arm Chair Arm Height: 25½" h
25" w x 22" d x 39½" h ECJSP-01A 🍷
Side Chair
18½" w x 22" d x 39½" h ECJSP-02A 🍷

c Justine Chair ⇄ ⇄

Arm chair Arm Height: 25" h
23" w x 22" d x 40" h KSJAC-🍷
Side chair
19" w x 22" d x 40" h KSJSC-🍷

d Kaskaskia Chair

Arm chair Arm Height: 25" h
24½" w x 23" d x 37½" h ECKAS-01A-🍷
Side chair
19½" w x 23½" d x 37½" h ECKAS-02A-🍷

🍷 Available with wood seat, fabric cushion seat or leather cushion seat. If using your own fabric please supply ½ yard. COM = Grade 3.



a Lakewood Chair

Arm chair Arm Height: 25¼" h
 23" w x 22¾" d x 37½" h ECLAK-01A-

Side chair
 18¾" w x 22¾" d x 37½" h ECLAK-02A-

b Lincoln Chair

Arm Chair Arm Height: 25½" h
 22" w x 24" d x 39" h ECLCN-01A

Side Chair
 18½" w x 24" d x 39" h ECLCN-02A

c Loft Chair

Arm chair Arm Height: 25½" h
 22½" w x 21" d x 42" h SALOA-

Side chair
 20½" w x 21" d x 42" h SALOS-

Loft Chair with Shorter Back (Not Shown)

Arm Chair Arm Height: 25½" h
 22½" w x 21" d x 38" h SALOA-4-

Side chair
 20½" w x 21" d x 38" h SALOS-4-

d Loft II Chair

Arm chair Arm Height: 26" h
 24" w x 24" d x 42½" h CCLIIA-

Side chair
 21" w x 24" d x 42½" h CCLIIS-

e Lydia Side Chair

19" w x 19½" d x 31" h ECLYD-02A-W

Available with wood seat, fabric cushion seat or leather cushion seat. If using your own fabric please supply ½ yard. COM = Grade 3.



a MäRyan Chair

Arm chair Arm Height: 26" h
24" w x 25½" d x 42½" h ECMRY-01A-

Side chair
19½" w x 25½" d x 42½" h ECMRY-02A-

b Maxwell Chair

Arm chair Arm Height: 25½" h
23" w x 22½" d x 37¾" h ECMAX-01A-

Side chair
18¾" w x 22½" d x 37¾" h ECMAX-02A-

c Miller Chair

Arm chair Arm Height: 25" h
23" w x 18½" d x 41¼" h SAMA-

Side chair
19½" w x 20" d x 41" h SAMS-

d Mitchell Chair

Arm chair Arm Height: 24¼" h
24¾" w x 21½" d x 38" h ECMIT-01A-

Side chair
19" w x 21" d x 38" h ECMIT-02A-

Available with wood seat, fabric cushion seat or leather cushion seat. If using your own fabric please supply ½ yard. COM = Grade 3.



a Shown with Olde World Level B Aging.



b







c



d

a Montauk Chair

Arm Chair  Arm Height: 25" h
24½" w x 20½" d x 39½" h ECMOK-01A-

Side Chair  
19" w x 20½" d x 39½" h ECMOK-02A-

b Newton Chair

Arm chair Arm Height: 26" h
22½" w x 23" d x 42¾" h SANEA-

Side chair
20" w x 23" d x 42¾" h SANES-

c Pierson Chair

Arm Chair Arm Height: 24½" h
22¾" w x 22½" d x 39" h ECPRN-01A 

Side Chair
18½" w x 22½" d x 39" h ECPRN-02A 

d Prairie Mission Chair 

Arm chair Arm Height: 26" h
26" w x 20½" d x 44" h LFSAC-

Side chair
18¾" w x 20½" d x 44" h LFSSC-

 Available with wood seat, fabric cushion seat or leather cushion seat. If using your own fabric please supply ½ yard. COM = Grade 3.



a Rachel Chair

Arm chair Arm Height: 25" h
24" w x 23" d x 39" h ECRCH-01A-☞
Side chair
19" w x 18" d x 39" h ECRCH-02A-☞

b Raymond Chair

Arm Chair Arm Height: 25½" h
24" w x 18" d x 38½" h ECRA-01A-☞
Side chair
19½" w x 18" d x 38½" h ECRA-02A-☞

c Sheffield Chair

Arm chair Arm Height: 25½" h
23¼" w x 22¼" d x 38" h SPSHA-☞
Side chair ☞☞
18¾" w x 22¼" d x 38" h SPSHS-☞

d Shenandoah Side Chair

18½" w x 21½" d x 35½" h ECSHS-02A-☞

☞ Available with wood seat, fabric cushion seat or leather cushion seat. If using your own fabric please supply ½ yard. COM = Grade 3.



a



b



c



d

a Southport Chair

Arm chair Arm Height: 25¾" h
23¼" w x 22¾" d x 39" h ECSTH-01A-☞

Side chair
19¾" w x 22¾" d x 39" h ECSTH-02A-☞

b Urbandale Chair ☞

Arm chair Arm Height: 25¾" h
24" w x 24" d x 42" h KSUAC-☞

Side chair
19" w x 24" d x 42" h KSUSC-☞

c Urbandale II Chair ☞☞☞

Arm chair Arm Height: 25¾" h
24" w x 24¾" d x 42" h KSUIIAC-☞

Side chair
19" w x 24¾" d x 42" h KSUIISC-☞

d Urbandale II Chair with Lower Back ☞

Arm Chair Arm Height: 25¾" h
24" w x 23¼" d x 37¼" h KSUIIAC-4-☞

Side Chair
19¼" w x 23¼" d x 37¼" h KSUIISC-4-☞

☞ Available with wood seat, fabric cushion seat or leather cushion seat. If using your own fabric please supply ½ yard. COM = Grade 3.

**a Victoria Chair**

Arm chair Arm Height: 25¼" h
20½" w x 17½" d x 38¼" h ECVIC-01A-👉

Side chair
18" w x 16½" d x 38¼" h ECVIC-02A-👉

b Waveland Side Chair

19" w x 21" d x 38¾" h ECWAV-02A-👉

c William Side Chair

18" w x 15¾" d x 36¾" h ECWLM-02A-W

d Wright Side Chair ⇄

18½" w x 22¾" d x 37¾" h ECWRI-02A-👉

e Buckingham Arm Desk Chair

24½" w x 25½" d WCBUC-01B-👉

f Kelsey Arm Desk Chair

22" w x 28" d SAKLA-👉

Overall arm height 38" to 42".

g Patterson Arm Desk Chair

25" w x 29½" d x 42" h WCPAT-01A-👉

Adjustable seat raises 3½"
Nailhead options available.

h Venture Arm Desk Chair

24½" w x 24½" d x 36" h SAVNADC-👉

Nailhead options available.

👉 Available with wood seat, fabric cushion seat or leather cushion seat. If using your own fabric please supply ½ yard. COM = Grade 3.

👉 Available with fabric cushion seat or leather cushion seat. If using your own fabric please supply 2½ yard. COM = Grade 3.



Advantage Fabrics

These fabrics are available as part of a special arrangement with the fabric mill to purchase three of their most popular fabrics in higher quantities and to pass the savings on to the consumer.

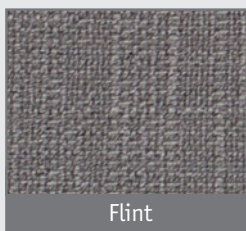

Flint

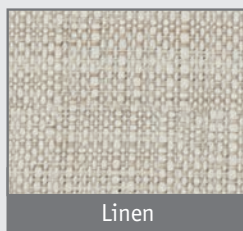

Linen

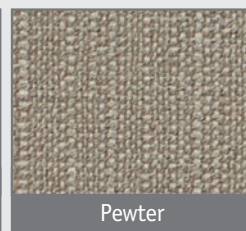

Pewter

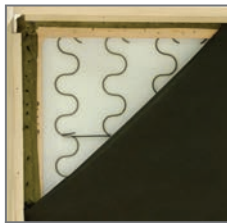

Sinuous Springs

For added comfort, select chairs feature **sinuous springs** beneath a foam seat.



ECOSKIRT—Skirt Option available on select Upholstered Chairs



a

b

c



d

e

f

a Abigail Chair
24" w x 18" d x 37" h ECABG-02A-☞

b Addison Chair
Arm chair Arm Height: 26" h
27 1/4" w x 26 1/2" dx 42 1/2" h ECADD-01A-☞
Side chair
21" w x 26 1/2" dx 42 1/2" h ECADD-02A-☞

c Byron Arm Chair
25" w x 27" d x 43" h ECBYR-01A-☞
Nailhead options available.
Features Sinuous Springs.

d Chandler Chair
Arm Chair Arm Height: 25 1/4" h
23 1/2" w x 22 1/2" d x 39 1/2" h ECCHN-01A-☞
Side Chair
19 1/2" w x 22 1/2" d x 39 1/2" h ECCHN-02A-☞
Not available in QSWO or Walnut.

e Claire Side Chair
19" w x 26" d x 39" h ECCLR-02A-☞
Skirt option available.
Nailhead options available.
Features Sinuous Springs.

f Cornelia Chair
Arm Chair Arm Height: 25 1/4" h
22 1/2" w x 24 1/4" d x 36 3/4" h ECCON-01A-☞
Side Chair
19 1/4" w x 24 1/4" d x 36 3/4" h ECCON-02A-☞

☞ Available with fabric or leather. If using your own fabric please supply 2 1/2 yard (Byron Chair 4 1/2 yards). COM = Grade 3.

Looking to set your dining room apart? With our nailhead options it's simple to add a touch of class.



Oxford Hammered
ECONH-0X



Z Finish
ECONH-ZF



Black
ECONH-BK



Pewter Nickel
ECONH-PN



Pewter Zinc
ECONH-PZ



Natural
ECONH-NT



French Natural
ECONH-FN

See price list for availability.



a



b



c



d



e



f



g



h

EAT
CHAIRS

a Devin Side Chair
17½" w x 16½" d x 32" h ECDEV-02A-🍴

b Karrige Side Chair
19" w x 23" d x 37" h ECKAR-02A-🍴
(Arm chair not available.)

Nailhead options available.
Features Sinuous Springs.

c Lana Side Chair
19" w x 26" d x 39" h ECLAN-02A-🍴

Skirt option available.
Nailhead options available.
Features Sinuous Springs.

d Shaw Arm Chair
25" w x 27" d x 43" h ECSHA-01A-🍴

Nailhead options available.
Features Sinuous Springs.

e Theo Side Chair
19" w x 25½" d x 36" h ECTHE-02A-🍴

Skirt option available.
Nailhead options available.
Features Sinuous Springs.

f Empire Chair
Arm chair Arm Height: 24¾" h
21¾" w x 24" d x 39" h ECEMP-01A-🍴

Side chair
19" w x 24" d x 39" h ECEMP-02A-🍴

g Olivia Side Chair
20½" w x 18" d x 41½" h ECOLV-02A-🍴

h Rosemont Chair
22¼" w x 22" d x 42" h ECROS-01A-🍴

🍴 Available with fabric or leather. If using your own fabric please supply 2½ yard (Shaw Chair 4½ yards). COM = Grade 3.

🍴 Available with fabric or leather. If using your own fabric please supply 1½ yard (Rosemont Chair ½ yard/seat). COM = Grade 3.

BARSTOOLS

EAT

SHEFFIELD BACKLESS BARSTOOLS SHOWN IN CHARACTER CHERRY, HAZELNUT

Sit or spin. Our barstools are available in two basic types — stationary and swivel. On stationary stools, the legs are attached directly to the base, just like a typical chair, while swivel barstools feature hardware that allows the seat to rotate while the legs remain in place.

Stationary and Swivel Barstools are available in your choice of two seat heights — 24" or 30", with a few available in 18".

Welcome to the spin zone. 

Standard Swivels: All swivel barstool selections feature this icon, indicating that your selection features a heavy-duty, ball-bearing swivel designed to pivot a full 360°. These high-quality swivels are made in America and backed by our lifetime guarantee.

Memory Swivels: For a slight upcharge, you can upgrade any Standard Swivel to a Memory Swivel. These deluxe swivels — also backed by our lifetime guarantee — are designed to rotate 90° in either direction and return to the forward-facing position whenever the seat is unoccupied.

Rung Guards

Protect your investment with our optional Stainless Steel Rung Guards. Installed to protect the finish on the area of the barstool that takes the most abuse, the cross bar. Can be installed on any barstool that has a rectangular cross bar.

Bronze Finish KA0BB

Brushed Stainless Finish KA0BR

STATIONARY BARSTOOL

SWIVEL BARSTOOL



BRONZE
FINISH

BRUSHED STAINLESS
FINISH

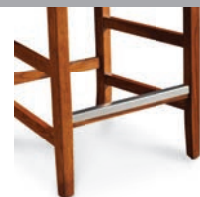



a

b

c



d



e



f

a 1979 Kenneth BarstoolArm stool 23 $\frac{3}{4}$ "w x 20 $\frac{1}{2}$ "d

24" Wood Seat; Plain Legs; Back 15"h	KA775BS24
24" Cushion Seat; Plain Legs; Back 13"h	KA735BS24-
30" Wood Seat; Plain Legs; Back 15"h	KA775BS30
30" Cushion Seat; Plain Legs; Back 13"h	KA735BS30-

Side stool 20"w x 21"d

24" Wood Seat; Plain Legs; Back 15"h	KA750BS24
24" Cushion Seat; Plain Legs; Back 13"h	KA725BS24-
30" Wood Seat; Plain Legs; Bac: 15"h	KA750BS30
30" Cushion Seat; Plain Legs; Back 13"h	KA725BS30-

b Albany Stationary Barstool

17"w x 16"d; Back 10"h

24" Seat Height	SAALBS24-
30" Seat Height	SAALBS30-

c Allison Stationary Barstool20"w x 22 $\frac{3}{4}$ "d; Back 21"h

24" Seat Height	SAANBS24-
30" Seat Height	SAANBS30-

d Arnold Stationary Barstool18 $\frac{1}{2}$ "w x 22 $\frac{1}{2}$ "d; Back 18" h

24"h Seat Height	ECARN-04C
30"h Seat Height	ECARN-04B

e Aspen Stationary Barstool18 $\frac{1}{2}$ "w x 21"d; Back 18 $\frac{1}{2}$ "h

24" Seat Height	SAABS24-
30" Seat Height	SAABS30-

f Aspen Swivel Barstool

18"w x 21"d; Back 21"h

24" Seat Height	SAA24SBS-
30" Seat Height	SAA30SBS-

Available with wood seat, fabric cushion seat or leather cushion seat. If using your own fabric please supply $\frac{1}{2}$ yard. COM = Grade 3.



360° SWIVEL

simplyamish



a



b

Standard with Memory Swivel



c



d



e



f



g



h

a B&O Railroad® Trestle Bridge Stationary Barstool

22" w x 23½" d; Back 20½" h

24" Seat Height ECTRB-04C-🍃

30" Seat Height ECTRB-04B-🍃

Swivel Barstool available.

b Bentback Swivel Barstool

18¾" w; Back 21½" h

24" Seat; Turned Leg KA1155BS-06C

30" Seat; Turned Leg KA1155BS-06B

Not available in quartersawn.

c Bradford Stationary Barstool

18" w x 21" d; Back 19½" h

24" Seat Height ECBRD-04C-🍃

30" Seat Height ECBRD-04B-🍃

d Bradley Stationary Barstool

20" w x 19" d; Back 20" h

24" Seat Height ECBRL-04C-🍃

30" Seat Height ECBRL-04B-🍃

e Bristol Stationary Barstool

18¾" w x 22¾" d; Back 17½" h

24" Seat Height ECBRS-04C-🍃

30" Seat Height ECBRS-04B-🍃

f Brookfield Stationary Barstool

21" w x 20" d; Back 15" h

24" Seat Height SABF24BS-🍃

30" Seat Height SABF30BS-🍃

g Cadira Stationary Barstool

Side stool 19" w x 21½" d; Back 17¾" h

24" Seat Height ECCDI-04C-🍃

30" Seat Height ECCDI-04B-🍃

h Campbell Stationary Barstool

19" w x 21¼" d; Back 21¼" h

24" Seat Height ECCAM-04C-🍃

30" Seat Height ECCAM-04B-🍃

🍃 Available with wood seat, fabric cushion seat or leather cushion seat. If using your own fabric please supply ½ yard. COM = Grade 3.



a



b



c



d



e



f



g



h



i

a Corbin Stationary Barstool18 $\frac{3}{4}$ "w x 22 $\frac{1}{2}$ "d x 50 $\frac{1}{2}$ "h; Back 20 $\frac{1}{2}$ "h

24" Seat Height ECCRB-04C-

30" Seat Height ECCRB-04B-

b Cornelia Stationary Barstool19 $\frac{1}{4}$ "w x 21 $\frac{3}{4}$ "d x 42 $\frac{1}{2}$ "h; Back 16 $\frac{1}{2}$ "h

24" Seat Height ECCON-04C-

30" Seat Height ECCON-04B-

c Cornelia Swivel Barstool 19 $\frac{1}{4}$ "w x 21 $\frac{3}{4}$ "d x 42 $\frac{1}{2}$ "h; Back 16 $\frac{1}{2}$ "h

24" Seat Height ECCON-06C-

30" Seat Height ECCON-06B-

d Franklin Stationary Barstool18 $\frac{1}{2}$ " x 21"d; Back 22 $\frac{1}{2}$ "h

24" Seat Height ECFRK-04C-

30" Seat Height ECFRK-04B-

e Grant Stationary Barstool18 $\frac{3}{4}$ "w x 20 $\frac{1}{2}$ "d; Back 19"h

24" Seat Height SAGRSBS24-

30" Seat Height SAGRSBS30-

f Grant II Stationary Barstool

18"w x 19"d; Back 18"h

24" Seat Height SAGRIIBS24-

30" Seat Height SAGRIIBS30-

g Hanna Stationary Barstool18 $\frac{3}{4}$ "w x 22 $\frac{1}{2}$ "d; Back 19 $\frac{1}{2}$ "h

24" Seat Height ECHAN-04C-

30" Seat Height ECHAN-04B-

h Hudson Stationary Barstool

18"w x 17"d; Back 16"h

24" Seat Height SAHUBS24-

30" Seat Height SAHUBS30-

i Joseph Stationary Barstool18 $\frac{1}{2}$ "w x 22"d; Back 19"h

24" Seat Height ECJSP-04C-

30" Seat Height ECJSP-04B-

Available with wood seat, fabric cushion seat or leather cushion seat. If using your own fabric please supply $\frac{1}{2}$ yard (Cornelia Barstools 1 $\frac{1}{2}$ yards). COM = Grade 3.



360° SWIVEL

simplyamish

BARSTOOLS

305



Standard with Memory Swivel



a Justine Stationary Barstool

18¾" w x 22" d; Back 19" h
 24" Seat Height KSJBSS24-
 30" Seat Height KSJBSS30-

b Justine Swivel Barstool

18" w x 21" d; Back 19" h
 24" Seat Height KAJBS-06C-
 30" Seat Height KAJBS-06B-

c Kaskaskia Stationary Barstool

Side stool 19" w x 22½" d; Back 18½" h
 24" Seat Height ECKAS-04C-
 30" Seat Height ECKAS-04B-

d Lincoln Stationary Barstool

18½" w x 21" d; Back 18" h
 24" Seat Height ECLCN-04C-
 30" Seat Height ECLCN-04B-

e Lincoln Swivel Barstool

18½" w x 21" d; Back 18" h
 24" Seat Height ECLCN-06C-
 30" Seat Height ECLCN-06B-

f Loft Stationary Barstool

19" w x 22" d; Back 18½" h
 24" Seat Height SALOBSS24-
 30" Seat Height SALOBSS30-

g Loft II Stationary Barstool

18¾" w x 23½" d; Back 21" h
 24" Seat Height ECL02-04C-
 30" Seat Height ECL02-04B-

h Loft II Swivel Barstool

Arm stool 24" w x 23½" d; Arm: 8" h; Back 21" h
 24" Seat Height ECL02-05C-
 30" Seat Height ECL02-05B-

Side stool 18¾" w x 23½" d; Back 21" h

24" Seat Height ECL02-06C-
 30" Seat Height ECL02-06B-

i Märjan Stationary Barstool

19¾" w x 24" d; Back 23¾" h
 24" Seat Height ECMRY-04C-
 30" Seat Height ECMRY-04B-

Available with wood seat, fabric cushion seat or leather cushion seat. If using your own fabric please supply ½ yard. COM = Grade 3.



a



b



c



d

Shown with
Olde World B Aging.



e



f



g



h



i

a Maxwell Stationary Barstool

Side stool 18 $\frac{3}{4}$ "w x 22"d; Back 18"h

24" Seat Height ECMAX-04C-

30" Seat Height ECMAX-04B-

b Mitchell Stationary Barstool

18 $\frac{1}{2}$ "w x 20 $\frac{3}{4}$ "d; Back 15"h

24" Seat Height ECMIT-04C-

30" Seat Height ECMIT-04B-

c Mitchell Swivel Barstool

18 $\frac{1}{2}$ "w x 20 $\frac{3}{4}$ "d; Back 15"h

24" Seat Height ECMIT-06C-

30" Seat Height ECMIT-06B-

d Montauk Stationary Barstool

18 $\frac{1}{2}$ "w x 21 $\frac{1}{2}$ "d; Back: 20 $\frac{1}{2}$ "h

24" Seat Height ECMOK-04C-

30" Seat Height ECMOK-04B-

e Newton Stationary Barstool

20"w x 22"d; Back 22"h

24" Seat Height SANESB24-

30" Seat Height SANESB30-

f Pasadena Stationary Barstool

16 $\frac{1}{2}$ "w x 15 $\frac{1}{2}$ "d; Back 14"h

24" Seat Height SAPABS24-

30" Seat Height SAPABS30-

g Prairie Mission Stationary Barstool

18 $\frac{1}{2}$ "w x 20"d; Back 22"h

24" Seat Height LFSSBS24-

30" Seat Height LFSSBS30-

h Rachel Stationary Barstool

18 $\frac{1}{2}$ "w x 21 $\frac{3}{4}$ "d; Back 15"h

24" Seat Height ECRCH-04C-

30" Seat Height ECRCH-04B-

i Rachel Swivel Barstool

18 $\frac{1}{2}$ "w x 22 $\frac{1}{4}$ "d; Back 15"h

24" Seat Height ECRCH-06C-

30" Seat Height ECRCH-06B-

Available with wood seat, fabric cushion seat or leather cushion seat. If using your own fabric please supply $\frac{1}{2}$ yard (Cornelia Barstools 1 $\frac{1}{2}$ yards). COM = Grade 3.



a



b



c



d



e

Standard with Memory Swivel



f



g



h

a Sheffield Stationary Barstool

18¾" w x 20¾" d; Back 15" h

24" Seat Height ECSHE-04C-🍃

30" Seat Height ECSHE-04B-🍃

b Sheffield Swivel Barstool 🔄

18¾" w x 20¾" d; Back 15" h

24" Seat Height ECSHE-06C-🍃

30" Seat Height ECSHE-06B-🍃

c Shenandoah Stationary Barstool

18¾" w x 20½" d; Back 18" h

24" Seat Height ECSHS-04C-🍃

30" Seat Height ECSHS-04B-🍃

d Urbandale Stationary Barstool

19" w x 22" d; Back 20½" h

24" Seat Height KSUBSS24-🍃

30" Seat Height KSUBSS30-🍃

e Urbandale II Swivel Barstool 🔄

Arm stool; 24" w x 22" d; Back 22" h; arm 7½" h

24" Seat Height KAUIIABS-05C-🍃

30" Seat Height KAUIIABS-05B-🍃

Side stool; 19" w x 22" d; Back 22" h

24" Seat Height KAUIISBS-06C-🍃

30" Seat Height KAUIISBS-06B-🍃

f Urbandale II Stationary Barstool

19" w x 24" d; Back 20¾" h

24" Seat Height KSUIIBSS24-🍃

30" Seat Height KSUIIBSS30-🍃

g Victoria Stationary Barstool

18" w x 18" d; Back 16½" h

24" Seat Height ECVIC-04C-🍃

30" Seat Height ECVIC-04B-🍃

h Wright Stationary Barstool

18½" w x 22¾" d; Back 21" h

24" Seat Height ECWRI-04C-🍃

30" Seat Height ECWRI-04B-🍃

🍃 Available with wood seat, fabric cushion seat or leather cushion seat. If using your own fabric please supply ½ yard. COM = Grade 3.

Looking to set your dining room apart? With our nailhead options it's simple to add a touch of class.



Oxford Hammered
ECONH-OX



Z Finish
ECONH-ZF



Black
ECONH-BK



Pewter Nickel
ECONH-PN



Pewter Zinc
ECONH-PZ



Natural
ECONH-NT



French Natural
ECONH-FN

See price list for availability.



a
Nailhead options available.



b
Nailhead options available.



c
Nailhead options available.



d
Nailhead options available.

a Claire Stationary Barstool ➔

19" w x 24" d; Back 14½" h

24" Seat Height ECCLR-04C- ➔

30" Seat Height ECCLR-04B- ➔

Nailhead options available.

b Lana Stationary Barstool ➔

18¾" w x 21½" d; Back 14½" h

24" Seat Height ECLAN-04C- ➔

30" Seat Height ECLAN-04B- ➔

Nailhead options available.

c Karrige Stationary Barstool ➔

18½" w x 23" d; Back 18½" h

24" Seat Height ECKAR-04C- ➔

30" Seat Height ECKAR-04B- ➔

Nailhead options available.

d Venture Swivel Barstool ⚙

24" w x 24" d; Back 15" h

24" Seat Height SAVN24- ➔

30" Seat Height SAVN30- ➔

Nailhead options available.

EAT

BARSTOOLS

➔ Available with fabric cushion seat or leather cushion seat. If using your own fabric please supply 2 yards. COM = Grade 3.



360° SWIVEL



ADVANTAGE FABRIC

simplyamish

BARSTOOLS

309



a



b



c



d



e



f

a Barrel Swivel Barstool with Back

19¼" w x 17¼" d; Back 11½" h

18" Seat Height RYBTSBS18-
 24" Seat Height RYBTSBS24-
 30" Seat Height RYBTSBS30-

c Aspen Swivel Backless Barstool with Inlay

16" w x 16" d

18" Seat Height ECASP-06D-W
 24" Seat Height ECASP-06C-W
 30" Seat Height ECASP-06B-W

e Barrel Swivel Barstool

Seat 16½" diameter

18" Seat Height RYBSBS18-
 24" Seat Height RYBSBS24-
 30" Seat Height RYBSBS30-

b Belmont Swivel Barstool with Back

19" w x 17¼" d; Back 11½" h

18" Seat Height RYBMTSBS18-
 24" Seat Height RYBMTSBS24-
 30" Seat Height RYBMTSBS30-

d B&O Railroad® Trestle Bridge Backless Stationary Barstool

18" w x 14" d

18" Seat Height ECTRB-08D-
 24" Seat Height ECTRB-08C-
 30" Seat Height ECTRB-08B-

f Belmont Swivel Barstool

Seat 16½" diameter

18" Seat Height RYBMSBS18-
 24" Seat Height RYBMSBS24-
 30" Seat Height RYBMSBS30-

Available with wood seat, fabric cushion seat or leather cushion seat. If using your own fabric please supply ½ yard. COM = Grade 3.



a



b



c



d



e



f

a Bowen Stationary Barstool

18" w x 14" d

18" Seat Height ECBOW-08D-🍃

24" Seat Height ECBOW-08C-🍃

30" Seat Height ECBOW-08B-🍃

b Logan Stationary Barstool

18" w x 14" d

18" Seat Height ECLOG-08D-🍃

24" Seat Height ECLOG-08C-🍃

30" Seat Height ECLOG-08B-🍃

c Clayton Swivel Barstool 🍃

18" w x 18½" d

24" Seat Height ECCLY-14C-🍃

30" Seat Height ECCLY-14B-🍃

d Community Backless Barstool

15" w x 15" d x 24" h ECCOM-08C-W

e Mason Swivel Barstool 🍃

17½" w x 18" d

24" Seat Height ECMSN-08C

30" Seat Height ECMSN-08B

f Portland Swivel Barstool 🍃

16" w x 16" d

18" Seat Height ECPTL-14D 🍃

24" Seat Height ECPTL-14C 🍃

30" Seat Height ECPTL-14B 🍃

🍃 Available with wood seat, fabric cushion seat or leather cushion seat. If using your own fabric please supply ½ yard. COM = Grade 3.



360° SWIVEL

simplyamish



a



b



c



d



e

a Sally Stationary Barstool

16" w x 12" d

18" Seat Height ECSAL-04D-

24" Seat Height ECSAL-04C-

30" Seat Height ECSAL-04B-

b Sara Stationary Barstool

18" w x 14" d

18" Seat Height ECSRA-04D

24" Seat Height ECSRA-04C

30" Seat Height ECSRA-04B

c Sector Stationary Barstool

18" w x 18" d x 24" h ECSEC-20C-

d Sheffield Backless Stationary Barstool

16" w x 16" d

18" Seat Height ECSHE-08D-

24" Seat Height ECSHE-08C-

30" Seat Height ECSHE-08B-

e Tuoli Stationary Barstool

16½" w x 16½" d

18" Seat Height ECTUO-04D-

24" Seat Height ECTUO-04C-

30" Seat Height ECTUO-04B-

Available with wood seat, fabric cushion seat or leather cushion seat. If using your own fabric please supply ½ yard. COM = Grade 3.



a



b



c



d



e



f

a Mission Saddle Stationary Barstool

22" w x 13" d

18" Seat Height	OLMSB18-W
24" Seat Height	OLMSB24-W
30" Seat Height	OLMSB30-W

b Mission Saddle Swivel Barstool

22" w x 13" d

18" Seat Height	OLMSSB18-W
24" Seat Height	OLMSSB24-W
30" Seat Height	OLMSSB30-W

c Saddle Stationary Stool

22" w x 13" d

18" Seat Height	OLSBS18-W
24" Seat Height	OLSBS24-W
30" Seat Height	OLSBS30-W

d Saddle Swivel Stool

22" w x 13 1/4" d

18" Seat Height	OLSSB18-W
24" Seat Height	OLSSB24-W
30" Seat Height	OLSSB30-W

e Torii Backless Stationary Barstool24" Seat Height

ECTOR-08C-W

30" Seat Height

ECTOR-08B-W

f Western Saddle Stationary Barstool

13 3/4" w x 21" d x 22 1/4" h

18" Saddle

ATWS18

14 1/4" w x 21" d x 27 1/2" h

24" Saddle

ATWS24

16 1/4" w x 21" d x 34" h

30" Saddle

ATWS30

Available with wood seat, fabric cushion seat or leather cushion seat. If using your own fabric please supply 1/2 yard. COM = Grade 3.

360° SWIVEL

simplyamish

BARSTOOLS

313

BENCHES

EAT



JUSTINE DINING BENCH SHOWN IN CHERRY, GOLD DUST



a



b

a Alexandria Dining Bench

36" w x 17" d x 18 1/4" h	ECALE-12A-W
48" w x 17" d x 18 1/4" h	ECALE-12B-W
60" w x 17" d x 18 1/4" h	ECALE-12C-W
72" w x 17" d x 18 1/4" h	ECALE-12D-W
80" w x 17" d x 18 1/4" h	ECALE-12E-W

b Aspen Dining Bench with Inlay

36" w x 17" d x 18" h	ECASP-12A-☛
48" w x 17" d x 18" h	ECASP-12B-☛
60" w x 17" d x 18" h	ECASP-12C-☛
72" w x 17" d x 18" h	ECASP-12D-☛
80" w x 17" d x 18" h	ECASP-12E-☛

Aspen Bench with Inlay

36" w x 14" d x 18" h	ECA770-36B
48" w x 14" d x 18" h	ECA770-48B
60" w x 14" d x 18" h	ECA770-60B
72" w x 14" d x 18" h	ECA770-72B

☛ Available with wood seat, fabric cushion seat or leather cushion seat. If using your own fabric, yardage will vary. COM=Grade 3.



Features Planked Seat

a Auburn Bay Bench

60" w x 16" d x 18" h
 72" w x 16" d x 18" h
 84" w x 16" d x 18" h
 96" w x 16" d x 18" h

ECABR-12C-W
 ECABR-12D-W
 ECABR-12F-W
 ECABR-12G-W



b Avalon Dining Bench

36" w x 17" d x 17½" h
 48" w x 17" d x 17½" h
 60" w x 17" d x 17½" h
 72" w x 17" d x 17½" h
 80" w x 17" d x 17½" h

ECAVA-15A-W
 ECAVA-15B-W
 ECAVA-15C-W
 ECAVA-15D-W
 ECAVA-15E-W

c B&O Railroad® Trestle Bridge Dining Bench

36" w x 17" d x 18" h
 48" w x 17" d x 18" h
 60" w x 17" d x 18" h
 72" w x 17" d x 18" h
 80" w x 17" d x 18" h

Planked seat standard.

ECTRB-12A-
 ECTRB-12B-
 ECTRB-12C-
 ECTRB-12D-
 ECTRB-12E-



d Brookfield Dining Bench

36" w x 17" d x 19" h
 48" w x 17" d x 19" h
 60" w x 17" d x 19" h
 72" w x 17" d x 19" h
 80" w x 17" d x 19" h

ECBRK-12A-
 ECBRK-12B-
 ECBRK-12C-
 ECBRK-12D-
 ECBRK-12E-

e Charleston Dining Bench

36" w x 17" d x 18" h
 48" w x 17" d x 18" h
 60" w x 17" d x 18" h
 72" w x 17" d x 18" h
 80" w x 17" d x 18" h

ECCHS-15A-W
 ECCHS-15B-W
 ECCHS-15C-W
 ECCHS-15D-W
 ECCHS-15E-W

f Claire Bench with Upholstery

48" w x 20" d x 20" h
 54" w x 20" d x 20" h
 60" w x 20" d x 20" h
 72" w x 20" d x 20" h
 84" w x 20" d x 20" h

ECCLR-16B-
 ECCLR-16H-
 ECCLR-16C-
 ECCLR-16D-
 ECCLR-16F-

Available with wood seat, fabric cushion seat or leather cushion seat. If using your own fabric, yardage will vary. COM=Grade 3.



a



b



c



d



e



f

a Claire Bench

48" w x 16" d x 18½" h
 54" w x 16" d x 18½" h
 60" w x 16" d x 18½" h
 72" w x 16" d x 18½" h
 84" w x 16" d x 18½" h

ECCLR-19B-
 ECCLR-19H-
 ECCLR-19C-
 ECCLR-19D-
 ECCLR-19F-

c Franklin Dining Trestle Bench

36" w x 17" d x 17¾" h
 48" w x 17" d x 17¾" h
 60" w x 17" d x 17¾" h
 72" w x 17" d x 17¾" h
 80" w x 17" d x 17¾" h

ECFRK-13A-W
 ECFRK-13B-W
 ECFRK-13C-W
 ECFRK-13D-W
 ECFRK-13E-W

b Franklin Dining Bench

36" w x 17" d x 18" h
 48" w x 17" d x 18" h
 60" w x 17" d x 18" h
 72" w x 17" d x 18" h
 80" w x 17" d x 18" h

ECFRK-12A-
 ECFRK-12B-
 ECFRK-12C-
 ECFRK-12D-
 ECFRK-12E-

d Franklin II Dining Trestle Bench

36" w x 17" d x 17¾" h
 48" w x 17" d x 17¾" h
 60" w x 17" d x 17¾" h
 72" w x 17" d x 17¾" h
 80" w x 17" d x 17¾" h

ECFR2-13A-W
 ECFR2-13B-W
 ECFR2-13C-W
 ECFR2-13D-W
 ECFR2-13E-W

e Hamptons Dining Trestle Bench

48" w x 17" d x 18¾" h
 60" w x 17" d x 18¾" h
 72" w x 17" d x 18¾" h
 84" w x 17" d x 18¾" h
 96" w x 17" d x 18¾" h

ECHAP-13B-W
 ECHAP-13C-W
 ECHAP-13D-W
 ECHAP-13F-W
 ECHAP-13G-W

f Ironwood Bench

48" w x 16" d x 18" h
 Black Base
 Gunmetal Base
 60" w x 16" d x 18" h
 Black Base
 Gunmetal Base
 72" w x 16" d x 18" h
 Black Base
 Gunmetal Base
 84" w x 16" d x 18" h
 Black Base
 Gunmetal Base

ECIRN-17B-W-B
 ECIRN-17B-W-C
 ECIRN-17C-W-B
 ECIRN-17C-W-C
 ECIRN-17D-W-B
 ECIRN-17D-W-C
 ECIRN-17F-W-B
 ECIRN-17F-W-C

Available with wood seat, fabric cushion seat or leather cushion seat. If using your own fabric, yardage will vary. COM=Grade 3.



a



b



c



d



e



f

a Justine Dining Bench

36" w x 17" d x 17½" h	ECJUS-12A-
48" w x 17" d x 17½" h	ECJUS-12B-
60" w x 17" d x 17½" h	ECJUS-12C-
72" w x 17" d x 17½" h	ECJUS-12D-
80" w x 17" d x 17½" h	ECJUS-12E-

b Large Square Leg Dining Bench

36" w x 17" d x 18" h	ECLSQ-13A-
48" w x 17" d x 18" h	ECLSQ-13B-
60" w x 17" d x 18" h	ECLSQ-13C-
72" w x 17" d x 18" h	ECLSQ-13D-
80" w x 17" d x 18" h	ECLSQ-13E-

c Loft Dining Trestle Bench

36" w x 17" d x 18" h	ECLFT-13A-W
48" w x 17" d x 18" h	ECLFT-13B-W
60" w x 17" d x 18" h	ECLFT-13C-W
72" w x 17" d x 18" h	ECLFT-13D-W
80" w x 17" d x 18" h	ECLFT-13E-W

Loft Trestle Bench

36" w x 11" d x 17¾" h	PLL36TB
48" w x 11" d x 17¾" h	PLL48TB
60" w x 11" d x 17¾" h	PLL60TB
72" w x 11" d x 17¾" h	PLL72TB

d MäKayla Dining Bench

36" w x 17" d x 18" h	ECMRY-12A-
48" w x 17" d x 18" h	ECMRY-12B-
60" w x 17" d x 18" h	ECMRY-12C-
72" w x 17" d x 18" h	ECMRY-12D-
80" w x 17" d x 18" h	ECMRY-12E-

e McCoy Bench

36" w x 13½" d x 18¾" h	SAMC36B
48" w x 13½" d x 18¾" h	SAMC48B
60" w x 13½" d x 18¾" h	SAMC60B
72" w x 13½" d x 18¾" h	SAMC72B

McCoy Dining Bench

36" w x 17" d x 18" h	ECMCC-12A-
48" w x 17" d x 18" h	ECMCC-12B-
60" w x 17" d x 18" h	ECMCC-12C-
72" w x 17" d x 18" h	ECMCC-12D-
80" w x 17" d x 18" h	ECMCC-12E-

f Mission Dining Bench

36" w x 17" d x 18" h	ECMIS-12A-
48" w x 17" d x 18" h	ECMIS-12B-
60" w x 17" d x 18" h	ECMIS-12C-
72" w x 17" d x 18" h	ECMIS-12D-
80" w x 17" d x 18" h	ECMIS-12E-

Mission Bench

36" w x 13" d x 18" h	IWMB36-W
48" w x 13" d x 18" h	IWMB48-W
60" w x 13" d x 18" h	IWMB60-W
72" w x 13" d x 18" h	IWMB72-W

Available with wood seat, fabric cushion seat or leather cushion seat. If using your own fabric, yardage will vary. COM=Grade 3.



a



b



c



d



e



f



g

a Mission Dining Trestle Bench

- 36" w x 17" d x 18" h ECMIS-13A-W
- 48" w x 17" d x 18" h ECMIS-13B-W
- 60" w x 17" d x 18" h ECMIS-13C-W
- 72" w x 17" d x 18" h ECMIS-13D-W
- 80" w x 17" d x 18" h ECMIS-13E-W

Mission Trestle Bench

- 36" w x 11" d x 18" h PLM36TB-W
- 48" w x 11" d x 18" h PLM48TB-W
- 60" w x 11" d x 18" h PLM60TB-W
- 72" w x 11" d x 18" h PLM72TB-W

b Montauk Dining Trestle Bench

Rough Sawn & Plank Top Standard.

- 48" w x 17" d x 18" h ECMOK-13B-W
- 60" w x 17" d x 18" h ECMOK-13C-W
- 72" w x 17" d x 18" h ECMOK-13D-W
- 84" w x 17" d x 18" h ECMOK-13F-W
- 96" w x 17" d x 18" h ECMOK-13G-W

c Montgomery Dining Bench

- 36" w x 17" d x 18" h ECMTG-15A-W
- 48" w x 17" d x 18" h ECMTG-15B-W
- 60" w x 17" d x 18" h ECMTG-15C-W
- 72" w x 17" d x 18" h ECMTG-15D-W
- 80" w x 17" d x 18" h ECMTG-15E-W

d Napa Dining Bench

- 36" w x 17" d x 18" h ECNAP-15A-W
- 48" w x 17" d x 18" h ECNAP-15B-W
- 60" w x 17" d x 18" h ECNAP-15C-W
- 72" w x 17" d x 18" h ECNAP-15D-W
- 80" w x 17" d x 18" h ECNAP-15E-W

e Parkdale Dining Trestle Bench

- 48" w x 16" d x 18½" h ECPAR-13B-W
- 60" w x 16" d x 18½" h ECPAR-13C-W
- 72" w x 16" d x 18½" h ECPAR-13D-W
- 84" w x 16" d x 18½" h ECPAR-13F-W
- 96" w x 16" d x 18½" h ECPAR-13G-W

f Prairie Mission Hearth Bench

- 32" w x 10½" d x 16" h TVPM32HB-W
 - 48" w x 10½" d x 18" h TVPM48HB-W
- Hinged seat with small storage area.

g Prairie Mission Bench

- 45" w x 17¼" d x 24" h TV260B-W
- Hinged seat with small storage area.



a Shenandoah Dining Trestle Bench

- 36" w x 17" d x 18" h ECSHS-13A-W
- 48" w x 17" d x 18" h ECSHS-13B-W
- 60" w x 17" d x 18" h ECSHS-13C-W
- 72" w x 17" d x 18" h ECSHS-13D-W
- 80" w x 17" d x 18" h ECSHS-13E-W

b Sheffield Dining Bench

- 45" w x 14" d x 18" h ECSHE-16I-
- 48" w x 14" d x 18" h ECSHE-16B-
- 54" w x 14" d x 18" h ECSHE-16H-
- 60" w x 14" d x 18" h ECSHE-16C-
- 72" w x 14" d x 18" h ECSHE-16D-
- 84" w x 14" d x 18" h ECSHE-16F-

c Trestle Bench

- 36" w x 11" d x 17 3/4" h PL36TB-W
- 48" w x 11" d x 17 3/4" h PL48TB-W
- 60" w x 11" d x 17 3/4" h PL60TB-W
- 72" w x 11" d x 17 3/4" h PL72TB-W

d Tremont Dining Trestle Bench

- 36" w x 17" d x 18" h ECTRE-13A-W
- 48" w x 17" d x 18" h ECTRE-13B-W
- 60" w x 17" d x 18" h ECTRE-13C-W
- 72" w x 17" d x 18" h ECTRE-13D-W
- 80" w x 17" d x 18" h ECTRE-13E-W

e Valhalla Dining Bench

- 36" w x 17" d x 18" h ECVAH-12A-W
- 48" w x 17" d x 18" h ECVAH-12B-W
- 60" w x 17" d x 18" h ECVAH-12C-W
- 72" w x 17" d x 18" h ECVAH-12D-W
- 80" w x 17" d x 18" h ECVAH-12E-W

f Wildwood Dining Trestle Bench

- 48" w x 16" d x 18" h ECWIL-13B-W
- 60" w x 16" d x 18" h ECWIL-13C-W
- 72" w x 16" d x 18" h ECWIL-13D-W
- 84" w x 16" d x 18" h ECWIL-13F-W
- 96" w x 16" d x 18" h ECWIL-13G-W

Available with wood seat, fabric cushion seat or leather cushion seat. If using your own fabric, yardage will vary. COM=Grade 3.



a



b



c



d

a Aspen Storage Bench with Inlay

54" w x 21" d x 49" h SAA48BB

Features small storage area under seat.
Not available in walnut.

b Aspen Small Storage Bench with Inlay

40" w x 15³/₄" d x 38" h ECA695SB

Features large storage area under seat.

c Franklin Storage Bench

54¹/₂" w x 22¹/₄" d x 43" h LFFSB

Features large storage area under seat.

d Grant Storage Bench

55" w x 22" d x 44" h LFGRSB

Features large storage area under seat.



a



b



c



d

a Loft Storage Bench

44" w x 22½" d x 41¾" h AJ38CB

54" w x 22½" d x 41¾" h AJ48CB

Features large storage area under seat.

b Prairie Mission Storage Bench

55¼" w x 23" d x 44" h LFPMSB48

Features large storage area under seat.

c Raised Panel Storage Bench

44" w x 20" d x 22" h SBWR-W

Features large storage area under seat.

Not available in walnut.

d Urbandale II Arm Bench

52½" w x 21" d x 42½" h KSUII48B-W



EXPRESS



QUICKSHIP

simplyamish

ENTERTAINMENT

LIVE



SHOWN IN CHERRY, MOCHA NUT

NATURAL FURNITURE FOR A DIGITAL WORLD. We don't do iPhones. Or TVs. Or even good old-fashioned stereos. At Simply Amish, we just "do" great furniture, like the exceptional line of entertainment centers you see featured here. In other words, we put our blood, sweat and tears into making furniture that fills your home with beauty. What you put in it after that is your business.

Variety is the spice of life!

With five different styles of glass to choose from, your selection can dramatically impact the look and feel of your furniture.



Plain



Beveled



Frosted



Water



Antique



a



b



c



d



e

a Alexandria Open TV Stand, 60"

60" w x 18" d x 29" h LEALE-B09C
 Open area: 50" w x 14½" d x 12½" h
 Component area: 50" w x 14½" d x 6" h

b Aspen Open TV Stand with Inlay, 48"

48" w x 20" d x 32" h ECASOTVS
 Open area: 40" w x 18" d x 13½" h
 Component area: 40" w x 18" d x 6" h

c Aspen 2-Drawer Open TV Stand with Inlay, 60"

60" w x 20" d x 32" h ECAL02DTVS
 Open area: 52" w x 18" d x 13½" h

d B&O Railroad® Trestle Bridge Open TV Stand

54" w x 18" d x 32" h LETRB-B09C
 Component area: 42" w x 16" d x 5½" h

60"

60" w x 18" d x 32" h LETRB-B09E 
 Component area: 48" w x 16" d x 5½" h

e B&O Railroad® Spike Open TV Stand, Large

60" w x 20" d x 30½" h LESPK-B09C
 Open area: 51½" w x 16½" d x 12½" h
 Component area: 51½" w x 16½" d x 6" h



a



b



c



d



e

a Justine Open TV Stand

40"

40" w x 18" d x 26" h KAJTVS40

Top opening: 34" w x 18" d x 5 3/4" h
Bottom opening: 34" w x 18" d x 5 3/4" h

50"

50" w x 18" d x 26" h KAJTVS50

Top opening: 44" w x 18" d x 5 3/4" h
Bottom opening: 44" w x 18" d x 5 3/4" h

b MäKayla Open TV Stand, 50"

50" w x 18" d x 25 1/4" h TVM1850TV

Top Opening: 39 1/2" w x 14 1/2" d x 6" h;
Bottom Opening: 39 1/2" w x 14 1/2" d x 7 1/2" h

c Mission Widescreen Open TV Stand

40"

40" w x 18" d x 25" h IW1840WTV

Top opening: 34" w x 16" d x 6" h
Bottom opening: 34" w x 16" d x 9 3/4" h

50"

50" w x 18" d x 25" h IW1850WTV

Top opening: 44" w x 16" d x 6" h
Bottom opening: 44" w x 16" d x 9 3/4" h

d Prairie Mission Widescreen Open TV Stand

40"

40" w x 18" d x 25" h TVPM1840TV

Top opening: 30" w x 16" d x 6" h
Bottom opening: 30" w x 16" d x 9 3/4" h

50"

50" w x 18" d x 25" h TVPM1850TV

Top opening: 40" w x 16" d x 6" h
Bottom opening: 40" w x 16" d x 9 3/4" h

e Prairie Mission TV Stand with Doors

34" w x 22" d x 31 1/2" h TVPMTVD

Component Area: 23 1/4" w x 20 1/2" d x 5" h
Door Area: 21 1/2" w x 19" d x 18 1/2" h

Features adjustable shelf.



a



b



c



d



e

a Aspen TV Stand with Inlay, 48½"

48½" w x 20" d x 36" h SAAS2049TV
Area behind doors: 20" w x 16" d x 16¾" h

Features one adjustable shelf behind each door.
Bottom drawer has media dividers.

b Classic TV Stand, 49¾"

49¾" w x 18¾" d x 33½" h TS720
Area behind doors: 22¾" w x 16½" d x 16½" h

Features one adjustable shelf behind each door.
Bottom drawer has media dividers.

c East Village TV Stand, 50"

50" w x 20" d x 34¾" h TS795
Area behind doors: 22" w x 16½" d x 16½" h

Features one adjustable shelf behind each door.
Bottom drawer has media dividers.

d Justine TV Stand, 50"

50" w x 19" d x 36" h MEJSTV
Area behind doors: 20" w x 16" d x 16¾" h

Features one adjustable shelf behind each door. Bottom
drawers have media dividers.

e Loft TV Stand, 50"

50" w x 19" d x 32" h TS770
Area behind doors: 20½" w x 16½" d x 16½" h

Features one adjustable shelf behind each door.
Bottom drawer has media dividers.



a



b



c



d



e

a Louis Philippe TV Stand, 50"

50"w x 20"d x 38"h TS710
Area behind doors: 20"w x 16"d x 16 3/4"h

Features one adjustable shelf behind each door.
Bottom drawer has media dividers.

b MäRyan TV Stand, 58"

58"w x 22"d x 39"h NWM1849TV
Area behind doors: 20"w x 16"d x 16 3/4"h

Features one adjustable shelf behind each door,
and secret drawers.
Bottom drawer has media dividers.

c McCoy TV Stand, 49"

49"w x 18"d x 29 1/2"h MAMC1849TV*
Area behind doors: 18 1/2"w x 15"d x 15"h

49"w x 21"d x 29 1/2"h MAMC2149TV*
Area behind doors: 18 1/2"w x 18"d x 15"h

Features one shelf behind each door.

d Park Avenue TV Stand, 49"

49"w x 21"d x 30"h MAPA2149TV

Area behind doors: 18 1/2"w x 18"d x 15"h
Features one shelf behind each door.

e Prairie Mission TV Stand, 49 1/2"

49 1/2"w x 18 3/4"d x 32"h TS735*
Area behind doors: 22 3/4"w x 16 1/2"d x 16"h

Features 1 adjustable shelf behind each door.
Bottom drawer has media dividers.



a



b



c



d



e

a Savannah TV Stand, 50"

50" w x 20" d x 34 3/4" h TS760
Area behind doors: 22 3/4" w x 16 3/4" d x 16 3/4" h

Features 1 adjustable shelf behind each door.
Bottom drawer has media dividers.

b Shaker TV Stand, 49 1/2"

49 1/2" w x 18 3/4" d x 33" h TS725
Area behind doors: 22 1/2" w x 16 1/2" d x 16 1/2" h

Features 1 adjustable shelf behind each door.
Bottom drawer has media dividers.

c Shaker TV Stand, 33 1/2"

33 1/2" w x 21" d x 30 1/2" h OITVS
Glass Door Area: 28 1/2" w x 18 1/2" d x 14 1/2" h

Features casters and adjustable shelf.

d Shaker Widescreen TV Stand, 43 3/4"

43 3/4" w x 21" d x 30 1/2" h OIWSTVS
Glass Door Area: 39" w x 18 1/2" d x 14 1/2" h

Features casters and adjustable shelf.

e Shenandoah TV Stand, 50 1/4"

50 1/4" w x 18 1/4" d x 35 1/4" h LESH-A01A
Area behind doors: 20 3/4" w x 16" d x 16 1/2" h

Features 1 adjustable shelf behind each door.
Bottom drawer has media dividers.



a



b



c



d



e

a Aspen TV Stand with Inlay

60½"

60½" w x 20" d x 36" h SAASP2060TV
Area behind doors: 20" w x 16" d x 16¾" h

72" (Not Shown)

72" w x 20" d x 36¾" h LEASP-A03E
Area behind door: 20" w x 16" d x 16¾" h

Features one adjustable shelf behind each door.
Bottom drawers have media dividers.

b Classic TV Stand

61½"

61½" w x 18¾" d x 33½" h TS820
Area behind doors: 20" w x 16½" d x 16½" h

72" (Not Shown)

72" w x 18¾" d x 33½" h LECLA-A03E
Area behind door: 19" w x 17" d x 16½" h

Features one adjustable shelf behind each door.
Bottom drawers have media dividers.

c East Village TV Stand

62"

62" w x 20" d x 34¾" h TS895
Area behind doors: 19" w x 17" d x 16½" h

72" (Not Shown)

72" w x 20" d x 34¾" h LEESV-A03E
Area behind door: 19" w x 17" d x 16½" h

Features one adjustable shelf behind each door.
Bottom drawers have media dividers.

d Justine TV Stand

62"

62" w x 19" d x 36" h MEJLTV
Area behind doors: 20" w x 16½" d x 16¾" h

72" (Not Shown)

72" w x 19" d x 36" h LEJUS-A03E
Area behind door: 23½" w x 16½" d x 17¾" h

Features one adjustable shelf behind each door.
Bottom drawers have media dividers.

e Loft TV Stand

62"

62" w x 19" d x 32¾" h TS870
Area behind doors: 20" w x 16½" d x 16½" h

72" (Not Shown)

72" w x 19" d x 32¾" h LELFT-A03E
Area behind door: 19" w x 17" d x 16½" h

Features one adjustable shelf behind each door.
Bottom drawers have media dividers.



a



b



c



d



e

a Louis Philippe TV Stand

62"

62" w x 20" d x 38" h TS810
Area behind doors: 20" w x 16" d x 16 3/4" h

72" (Not Shown)

72" w x 20" d x 38" h LELPP-A03E
Area behind doors: 20" w x 16" d x 16 3/4" h

Features one adjustable shelf behind each door.
Bottom drawers have media dividers.

b MäRyan TV Stand

70" w x 22" d x 39" h NWM1860TV

Area behind doors: 21 1/4" w x 17" d x 16 3/4" h

Features one adjustable shelf behind each door,
and secret drawers. Bottom drawers have media
dividers.

c McCoy TV Stand 

60" w x 18" d x 29 1/2" h MAMC1860TV*

Area behind doors: 18 1/2" w x 15" d x 15" h

60" w x 21" d x 29 1/2" h MAMC2160TV*

Area behind doors: 18 1/2" w x 18" d x 15" h

Features one shelf behind each door.

d Montauk Media Unit

Rough Sawn & Plank Top Standard

60" w x 18 3/4" d x 28" h LEMOK-K29C

72" w x 18 3/4" d x 28" h LEMOK-K29E

Area behind doors: 20" w x 17" d x 21 3/4" h

e Park Avenue TV Stand

60" w x 21" d x 30" h MAPA2160TV

Area behind doors: 18 1/2" w x 18" d x 15" h

Features one shelf behind each door.



a



b



c



d



e

a Parkdale Media Unit

60" w x 20½" d x 28¼" h LEPAR-K29C
 72" w x 20½" d x 28¼" h LEPAR-K29E
 Area behind doors: 17½" w x 18¾" d x 20" h

b Prairie Mission TV Stand

61½" w x 18¾" d x 31½" h TS835*
 Area behind doors: 19½" w x 16½" d x 16" h

72" (Not Shown)
 72" w x 18¾" d x 31½" h LEPM5-A03E*
 Area behind door: 19" w x 17" d x 16" h

Features 1 adjustable shelf behind each door. Bottom drawers have media dividers.

c Savannah TV Stand

62" w x 20" d x 34¾" h TS860
 Area behind doors: 21½" w x 16½" d x 16½" h

72" (Not Shown)
 72" w x 20" d x 34¾" h LESAV-A03E
 Area behind door: 19" w x 17" d x 16½" h

Features 1 adjustable shelf behind each door. Bottom drawers have media dividers.

d Shaker TV Stand

61½" w x 18¾" d x 33½" h TS825C
 Area behind doors: 19" w x 16¾" d x 16½" h

72" (Not Shown)
 72" w x 18¾" d x 33½" h LESKR-A03E
 Area behind door: 19" w x 17" d x 16½" h

Features 1 adjustable shelf behind each door. Bottom drawers have media storage.

e Shenandoah TV Stand

62" w x 18" d x 35¼" h LESHS-A03C
 Area behind doors: 20" w x 16" d x 16½" h

72" (Not Shown)
 72" w x 18" d x 35¼" h LESHS-A03E
 Area behind doors: 20" w x 16" d x 16½" h

Features 1 adjustable shelf behind each door. Bottom drawers have media storage.



a



b



c



d



e

a Aspen 3-Door TV Stand with Inlay

66" w x 20" d x 32" h ECAHDTV
 Glass door area: 20" w x 16 3/4" d x 21" h
 Side doors area: 16 1/2" w x 16 3/4" d x 21" h

Features two adjustable shelves behind each door.

b Auburn Bay TV Console

60" w x 18" d x 28" h LEABR-C41C
 72" w x 18" d x 28" h LEABR-C41E

Open center area: 60" : 20" w x 21" h
 72" : 32" w x 21" h
 Side doors: ALL: 17" w x 21" h

c Classic 3-Door TV Stand

61 1/2" w x 19" d x 32" h TS120C
 Glass door area: 20" w x 16 3/4" d x 24" h
 Side doors area: 17" w x 16 3/4" d x 24" h

Features two adjustable shelves behind each door.

d Crawford Media Unit

61 1/2" w x 19 3/4" d x 30" h LECRA-K30C
 73 1/2" w x 19 3/4" d x 30" h LECRA-K30E

Features push-to-open doors.

e Garrett TV Console with Wood Doors and Open Center

54" w x 18 1/4" d x 28 1/2" h LEGAR-C41B
 60" w x 18 1/4" d x 28 1/2" h LEGAR-C41C
 72" w x 18 1/4" d x 28 1/2" h LEGAR-C41E

Open center area: All: 20 1/2" w x 16 1/2" d x 21" h
 Side doors area: 54" : 13" w x 16 1/2" d x 21" h
 60" : 16" w x 16 1/2" d x 21" h
 72" : 22" w x 16 1/2" d x 21" h

Features one adjustable shelf in center and behind each door.



a



b



c



d



e

a Garrett TV Console with Glass Doors and Open Center

54" w x 18 1/4" d x 28 1/2" h LEGAR-C42B
 60" w x 18 1/4" d x 28 1/2" h LEGAR-C42C
 72" w x 18 1/4" d x 28 1/2" h LEGAR-C42E

Open center area: All: 20 1/2" w x 16 1/2" d x 21" h
 Side doors area: 54": 13" w x 16 1/2" d x 21" h
 60": 16" w x 16 1/2" d x 21" h
 72": 22" w x 16 1/2" d x 21" h

Features one adjustable shelf in center and behind each door.

b Garrett TV Console with No Doors

54" w x 18 1/4" d x 28 1/2" h LEGAR-C43B
 60" w x 18 1/4" d x 28 1/2" h LEGAR-C43C
 72" w x 18 1/4" d x 28 1/2" h LEGAR-C43E

Open center area: All: 20 1/2" w x 16 1/2" d x 21" h
 Side doors area: 54": 13" w x 16 1/2" d x 21" h
 60": 16" w x 16 1/2" d x 21" h
 72": 22" w x 16 1/2" d x 21" h

Features three adjustable shelves.

c Ironwood TV Console

60" w x 18 1/4" d x 28" h
 Black Base LEIRN-C41C-B
 Gunmetal Base LEIRN-C41C-C

72" w x 18 1/4" d x 28" h
 Black Base LEIRN-C41E-B
 Gunmetal Base LEIRN-C41E-C

d Loft 3-Door TV Stand

62" w x 19" d x 32" h TS170S
 Glass door area: 19" w x 16 1/2" d x 25 1/2" h
 Side doors area: 14" w x 16 1/2" d x 25 1/2" h
 Features two adjustable shelves behind each door.

e McCoy 3-Door TV Stand

66" w x 19 1/2" d x 32" h TS190MC
 Glass door area: 20" w x 16 1/2" d x 23 3/4" h
 Side doors area: 17" w x 16 1/2" d x 23 3/4" h
 Features two adjustable shelves behind each door.



a



b



c



d



e

a Prairie Mission 3-Door TV Stand

61½" w x 19" d x 32" h TS135PM*
 Glass door area: 20" w x 16¾" d x 25" h
 Side doors area: 17¾" w x 16¾" d x 25" h

Features two adjustable shelves behind each door.

b San Miguel TV Console with Wood Doors and Open Center

54" w x 18¾" d x 28½" h LEMIG-C41B
 60" w x 18¾" d x 28½" h LEMIG-C41C
 72" w x 18¾" d x 28½" h LEMIG-C41E
 Open center area: All: 20½" w x 16½" d x 23" h
 Side doors area: 54": 14½" w x 16½" d x 23" h
 60": 17½" w x 16½" d x 23" h
 72": 23½" w x 16½" d x 23" h

Features one adjustable shelf in center and behind each door.

c San Miguel TV Console with Glass Doors and Open Center

54" w x 18¾" d x 28½" h LEMIG-C42B
 60" w x 18¾" d x 28½" h LEMIG-C42C
 72" w x 18¾" d x 28½" h LEMIG-C42E
 Open center area: All: 20½" w x 16½" d x 23" h
 Side doors area: 54": 14½" w x 16½" d x 23" h
 60": 17½" w x 16½" d x 23" h
 72": 23½" w x 16½" d x 23" h

Features one adjustable shelf in center and behind each door.

d San Miguel TV Console with No Doors

54" w x 18¾" d x 28½" h LEMIG-C43B
 60" w x 18¾" d x 28½" h LEMIG-C43C
 72" w x 18¾" d x 28½" h LEMIG-C43E
 Open center area: All: 20½" w x 16½" d x 23" h
 Side doors area: 54": 14½" w x 16½" d x 23" h
 60": 17½" w x 16½" d x 23" h
 72": 23½" w x 16½" d x 23" h

Features three adjustable shelves.

e Savannah 3-Door TV Stand

62¼" w x 20¼" d x 32" h TS160S
 Glass door area: 20" w x 17" d x 22½" h
 Side doors area: 15½" w x 17" d x 22½" h

Features two adjustable shelves behind each door.

* Not Available with Beveled Glass.



a



b



c



d

Shown with Olde World Finish.



e

Shown with Olde World Finish and optional hardware.
Comes standard with 70-E-11 hardware.

a Shaker 3-Door TV Stand

61½" w x 19" d x 32" h TS125S
Glass door area: 20" w x 16¾" d x 24" h
Side doors area: 17" w x 16¾" d x 24" h

Features two adjustable shelves behind each door.

b Shenandoah TV Console with Wood Doors and Open Center

54" w x 18¼" d x 28½" h LESHS-C41B
60" w x 18¼" d x 28½" h LESHS-C41C 
72" w x 18¼" d x 28½" h LESHS-C41E
Open center area: All — 20½" w x 17" d x 21" h
Side doors area: 54" — 14" w x 17" d x 21" h
60" — 17" w x 17" d x 21" h
72" — 23" w x 17" d x 21" h

Features one adjustable shelf in center and behind each door.

c Shenandoah TV Console with Glass Doors and Open Center

54" w x 18¼" d x 28½" h LESHS-C42B
60" w x 18¼" d x 28½" h LESHS-C42C
72" w x 18¼" d x 28½" h LESHS-C42E
Open center area: All — 20½" w x 17" d x 21" h
Side doors area: 54" — 14" w x 17" d x 21" h
60" — 17" w x 17" d x 21" h
72" — 23" w x 17" d x 21" h

Features one adjustable shelf in center and behind each door.

d Shenandoah TV Console with No Doors

54" w x 18¼" d x 28½" h LESHS-C43B
60" w x 18¼" d x 28½" h LESHS-C43C
72" w x 18¼" d x 28½" h LESHS-C43E
Open center area: All — 20½" w x 17" d x 21" h
Side doors area: 54" — 14" w x 17" d x 21" h
60" — 17" w x 17" d x 21" h
72" — 23" w x 17" d x 21" h

Features three adjustable shelves.

e Sophia TV Console

61"
61" w x 20" d x 26¾" h LESOP-A34C
Area behind doors: 20" w x 16" d x 17½" h

72" (Not Shown)

72" w x 20" d x 26¾" h LESOP-A34E
Area behind doors: 20" w x 16" d x 17½" h

Shown with Olde World Finish.



a



b



c



d



e

a Aspen TV Console with Inlay

60½"

60½" w x 20" d x 27¼" h LEASP-A34C
Area behind door: 20" w x 16" d x 16¾" h

72" (Not Shown)

72" w x 20" d x 27¼" h LEASP-A34E
Area behind door: 20" w x 16" d x 16¾" h

b B&O Railroad® Trestle Bridge TV Console

63"

63" w x 19" d x 29" h LETRB-A34C
Area behind doors: 19" w x 15¼" d x 16½" h

75" (Not Shown)

75" w x 19" d x 29" h LETRB-A34E
Area behind doors: 19" w x 15¼" d x 16½" h

Features one shelf behind each door.

c East Village TV Console

62"

62" w x 20" d x 25¼" h LEESV-A34C
Area behind door: 19" w x 17" d x 16½" h

72" (Not Shown)

72" w x 20" d x 25¼" h LEESV-A34E
Area behind door: 19" w x 17" d x 16½" h

Features one adjustable shelf behind each door.

d Frisco TV Console

60" w x 18¾" d x 25½" h FEFRI-C33C
72" w x 18¾" d x 25½" h FEFRI-C33E

Features 1 adjustable glass shelf.

e Grant TV Console

61"

61" w x 18½" d x 24" h LEGRA-A34C
Area behind door: 19½" w x 16½" d x 16" h

72"

72" w x 18½" d x 24" h LEGRA-A34E
Area behind door: 19½" w x 16½" d x 16" h

Features one adjustable shelf behind each door.



a



b



c



d



e

a Justine TV Console

62"

62" w x 18 3/4" d x 26 1/4" h LEJUS-A34C
Area behind door: 20" w x 16 1/2" d x 17 3/4" h

72" (Not Shown)

72" w x 18 3/4" d x 26 1/4" h LEJUS-A34E
Area behind door: 20" w x 16 1/2" d x 17 3/4" h

Features one adjustable shelf behind each door.

b Loft TV Console

62" 

62" w x 19" d x 23 3/4" h LELFT-A34C
Area behind door: 19" w x 17" d x 16 1/2" h

72" (Not Shown)

72" w x 19" d x 23 3/4" h LELFT-A34E
Area behind door: 19" w x 17" d x 16 1/2" h

Features one adjustable shelf behind each door.

c Louis Philippe TV Console

62"

62" w x 19 1/2" d x 29 1/2" h LELPP-A34C
Area behind doors: 20" w x 16" d x 16 3/4" h

72" (Not Shown)

72" w x 19 1/2" d x 29 1/2" h LELPP-A34E
Area behind doors: 20" w x 16" d x 16 3/4" h

Features one adjustable shelf behind each door.

d MärRyan TV Console, 70"

70" w x 22" d x 29 3/4" h LEMRY-A34C

Area behind doors: 21" w x 16 1/2" d x 16 1/2" h

Features one adjustable shelf behind each door.

e Prairie Mission TV Console

62"

62" w x 18 3/4" d x 23 1/8" h LEPMS-A34C*
Area behind door: 19" w x 17" d x 16" h

72" (Not Shown)

72" w x 18 3/4" d x 23 1/8" h LEPMS-A34E*
Area behind door: 19" w x 17" d x 16" h

Features one adjustable shelf behind each door.



a



b



c



d



e

a Savannah TV Console

62"
 62" w x 20" d x 25 3/4" h LESAV-A34C
 Area behind door: 19" w x 17" d x 16 1/2" h

72" (Not Shown)
 72" w x 20" d x 25 3/4" h LESAV-A34E
 Area behind door: 19" w x 17" d x 16 1/2" h

Features one adjustable shelf behind each door.

b Shaker TV Console

62"
 62" w x 18 3/4" d x 24 3/4" h LESKR-A34C
 Area behind door: 19" w x 17" d x 16 1/2" h

72" (Not Shown)
 72" w x 18 3/4" d x 24 3/4" h LESKR-A34E
 Area behind door: 19" w x 17" d x 16 1/2" h

Features one adjustable shelf behind each door.

c Shenandoah TV Console

62" w x 18" d x 25 1/4" h LESHS-C34C
 Area behind doors: 20" w x 16" d x 16 1/2" h

72" w x 18" d x 25 1/4" h LESHS-C34E
 Area behind doors: 20" w x 16" d x 16 1/2" h

d Aspen TV Stand with Soundbar Shelf and Inlay

54"
 54" w x 18" d x 32 1/2" h LEASP-L40B
 Openings - Top: 45" w x 15 3/4" d x 5" h;
 Center: 19" w x 15 3/4" d x 15" h; Door: 11 1/2" w x 15 3/4" d x 15" h

62"
 62" w x 18" d x 32 1/2" h LEASP-L40C
 Openings - Top: 53" w x 15 3/4" d x 5" h;
 Center: 19" w x 15 3/4" d x 15" h; Door: 15 1/2" w x 15 3/4" d x 15" h

72" (Not Shown)
 72" w x 18" d x 32 1/2" h LEASP-L40E
 Openings - Top: 65" w x 15 3/4" d x 5" h;
 Center: 27 1/2" w x 15 3/4" d x 15" h; Door: 17 1/2" w x 15 3/4" d x 15" h

e Classic TV Stand with Soundbar Shelf

55 1/2"
 55 1/2" w x 18 3/4" d x 32 1/2" h LECLA-L40B
 Openings - Top: 52 1/2" w x 17 3/4" d x 5" h;
 Center: 19 1/2" w x 17 3/4" d x 19" h; Door: 14 3/4" w x 17 3/4" d x 19" h

61 1/2"
 61 1/2" w x 18 3/4" d x 32 1/2" h LECLA-L40C
 Openings - Top: 58" w x 17 3/4" d x 5" h;
 Center: 19 3/4" w x 17 3/4" d x 19" h; Door: 18 1/2" w x 17 3/4" d x 19" h

73 1/2" (Not Shown)
 73 1/2" w x 18 3/4" d x 32 1/2" h LECLA-L40E
 Openings - Top: 69" w x 17 3/4" d x 5" h;
 Center: 25 1/2" w x 17 3/4" d x 19" h; Door: 21 3/4" w x 17 3/4" d x 19" h



a



b



c



d



e

a Justine TV Stand with Soundbar Shelf

54"

54" w x 19" d x 32½" h LEJUS-L40B

Openings - Top: 47½" w x 17¾" d x 5" h;
Center: 19" w x 17¾" d x 16½" h; Door: 12¾" w x 17¾" d x 16½" h

62"

62" w x 19" d x 32½" h LEJUS-L40C

Openings - Top: 55½" w x 17¾" d x 5" h;
Center: 19" w x 17¾" d x 16½" h; Door: 16¾" w x 17¾" d x 16½" h

74"

74" w x 19" d x 32½" h LEJUS-L40E

Openings - Top: 67½" w x 17¾" d x 5" h;
Center: 27½" w x 17¾" d x 16½" h; Door: 18¾" w x 17¾" d x 16½" h

b Loft TV Stand with Soundbar Shelf

56"

56" w x 19" d x 32½" h LELFT-L40B

Openings - Top: 48" w x 17¾" d x 5" h;
Center: 19" w x 17¾" d x 19" h; Door: 13¾" w x 17¾" d x 19" h

62"

62" w x 19" d x 32½" h LELFT-L40C

Openings - Top: 55" w x 17¾" d x 5" h;
Center: 19" w x 17¾" d x 19" h; Door: 17" w x 17¾" d x 19" h

74"

74" w x 19" d x 32½" h LELFT-L40E

Openings - Top: 66" w x 17¾" d x 5" h;
Center: 21" w x 17¾" d x 19" h; Door: 21" w x 17¾" d x 19" h

c Naomi 4-Drawer Open TV Stand

48" w x 19½" d x 29¼" h LENA0-A04B

60" w x 19½" d x 29¼" h LENA0-A04C

72" w x 19½" d x 29¼" h LENA0-A04E

Open center area:

48": 41½" x 5¾"; 60": 53½" x 5¾"; 72": 65½" x 5¾"

d Shenandoah TV Stand with Soundbar Shelf

56"

56" w x 18" d x 32½" h LESHS-L40B

Openings - Top: 49" w x 16" d x 5" h;
Center: 19" w x 16" d x 17" h; Door: 13½" w x 16" d x 17" h

62"

62" w x 18" d x 32½" h LESHS-L40C

Openings - Top: 55" w x 16" d x 5" h;
Center: 19" w x 16" d x 17" h; Door: 16½" w x 16" d x 17" h

74"

74" w x 18" d x 32½" h LESHS-L40E

Openings - Top: 67" w x 16" d x 5" h;
Center: 21" w x 16" d x 17" h; Door: 21½" w x 16" d x 17" h

e Wildwood Media Unit

54" w x 20" d x 20¾" h LEWIL-K05B

66" w x 20" d x 20¾" h LEWIL-K39C



a



b



c



d

a Aspen 2-Piece Widescreen Center with Inlay

66" w x 21" d x 74" h ECA760EC
 TV area: 57" w x 17" d x 38 1/4" h
 Glass door area: 20" w x 16 3/4" d x 21" h
 Side doors area: 16 1/2" w x 16 3/4" d x 21" h
 Features two adjustable shelves behind each door and one adjustable shelf in TV area.
 Delivers in 2 pieces.

b Classic 2-Piece Widescreen Center

65" w x 20 1/2" d x 76 1/2" h TS220C
 TV area: 57" w x 17" d x 40" h
 Glass door area: 20" w x 16 3/4" d x 24" h
 Side doors area: 17" w x 16 3/4" d x 24" h
 Features two adjustable shelves behind each door and one adjustable shelf in TV area.
 Delivers in 2 pieces.

c Loft 2-Piece Widescreen Center

60" w x 19" d x 75" h TS270L
 TV area: 54" w x 17" d x 41" h
 Glass door area: 19" w x 16 1/2" d x 25 1/2" h
 Side doors area: 14" w x 16 1/2" d x 25 1/2" h
 Features two adjustable shelves behind each door and one adjustable shelf in TV area.
 Delivers in 2 pieces.

d McCoy 2-Piece Widescreen Center

66 1/2" w x 20 1/2" d x 77 1/2" h TS290MC
 TV area: 57" w x 17" d x 41" h
 Glass door area: 20" w x 16 1/2" d x 23 3/4" h
 Side doors area: 17" w x 16 1/2" d x 23 3/4" h
 Features two adjustable shelves behind each door and one adjustable shelf in TV area.
 Delivers in 2 pieces.



a



b



c



d

a Shaker 2-Piece Widescreen Center

61½" w x 18¾" d x 74½" h TS225S

TV area: 57" w x 17" d x 40" h

Glass door area: 20" w x 16¾" d x 24" h

Side doors area: 17" w x 16¾" d x 24" h

Features two adjustable shelves behind each door and one adjustable shelf in TV area.

Delivers in 2 pieces.

b Aspen Deluxe Entertainment Center with Inlay *

86" w x 19" d x 82" h ECA785

Base only ECA785B0

TV area: 54" w x 17" d x 38½" h,

TV is 28" off floor.

Glass door area: 19" w x 17" d x 17½" h

Wood door area: 16 ½" w x 17 ½" h

Delivers in 2 pieces.

c Classic Deluxe Entertainment Center *

85¼" w x 19" d x 82" h TS2020DC

Base only TS2020B0

TV area: 54½" w x 17" d x 39" h,

TV is 28" off floor.

Glass door area: 19" w x 17" d x 20" h

Wood door area: 16 ½" w x 17 ½" h

Delivers in 2 pieces.

d Justine Deluxe Entertainment Center *

82" w x 19" d x 83" h LEJUS-E16D

Base only LEJUS-E32D

TV area: 54½" w x 9¾" d x 38½" h,

TV is 28" off floor.

Glass door area: 18½" w x 17" d x 18½" h

Wood door area: 16½" w x 17½" h

Delivers in 2 pieces.

Note: All Deluxe Entertainment Centers feature adjustable shelf behind doors, 3-LED light system (1 in each area above the TV) and 3 adjustable shelves in the areas next to the TV area.



a



b



c



d

LIVE ENTERTAINMENT

a McCoy Deluxe Entertainment Center *
 91" w x 19" d x 82" h TS2090DMC
 Base only TS2090B0
 TV area: 54 $\frac{3}{4}$ " w x 17" d x 38 $\frac{3}{4}$ " h,
 TV is 28" off floor.
 Glass door area: 19" w x 17" d x 20 $\frac{1}{2}$ " h
 Wood door area: 16 $\frac{1}{2}$ " w x 17" d x 20 $\frac{1}{2}$ " h
 Delivers in 2 pieces.

b Prairie Mission Deluxe Entertainment Center *
 86 $\frac{1}{2}$ " w x 19" d x 82" h TS2035DPM*
 Base only TS2035B0*
 TV area: 54 $\frac{1}{4}$ " w x 17" d x 38 $\frac{1}{2}$ " h,
 TV is 28" off floor.
 Glass door area: 19" w x 17" d x 21" h
 Wood door area: 16 $\frac{1}{2}$ " w x 17" d x 17 $\frac{1}{2}$ " h
 Delivers in 2 pieces.

c Aspen Wall Unit Entertainment Center with Inlay
 112 $\frac{1}{2}$ " w x 21" d x 75 $\frac{1}{2}$ " h ECA765EC
 TV Area: 58" w x 17" d x 44 $\frac{1}{2}$ " h,
 TV is 25" off floor
 Glass Door Area: 21" w x 17" d x 46 $\frac{1}{2}$ " h
 Base Door Areas: 19" w x 17" d x 16 $\frac{1}{2}$ " h
 Features four drawers with media storage, three adjustable shelves in each side unit, one adjustable shelf in TV area and one shelf behind each door. Plain glass in side unit doors.
 Delivers in 5 pieces.

d Classic Wall Unit Entertainment Center
 111 $\frac{1}{2}$ " w x 20 $\frac{1}{2}$ " d x 74 $\frac{1}{2}$ " h OI310C*
 TV Area: 58" w x 17" d x 45 $\frac{1}{4}$ " h,
 TV is 25" off floor
 Glass Door Area: 21" w x 17" d x 46" h
 Base Door Areas: 17" w x 17" d x 17" h
 Features four drawers with media storage, three adjustable shelves in each side unit, one adjustable shelf in TV area and one shelf behind each door.
 Delivers in 5 pieces.

Note: All Deluxe Entertainment Centers feature adjustable shelf behind doors, 3-LED light system (1 in each area above the TV) and 3 adjustable shelves in the areas next to the TV area.



a



b



c



d

a East Village Wall Entertainment Center

117" w x 19½" d x 74" h OI360

TV Area: 58" w x 17" d x 46½" h,
TV is 25½" off floor

Glass Door Area: 21" w x 17" d x 47" h
Base Door Areas: 15½" w x 17" d x 16½" h

Features four drawers with media storage, three adjustable shelves in each side unit, one adjustable shelf in TV area and one shelf behind each door. Plain glass in side unit doors.

Delivers in 5 pieces.

b Loft Wall Unit Entertainment Center

110" w x 19½" d x 75" h OI330L

TV Area: 58" w x 17" d x 46¾" h,
TV is 24" off floor

Glass Door Area: 17¾" w x 16" d x 47" h
Base Door Areas: 15½" w x 17" d x 17½" h

Features four drawers with media storage, three adjustable shelves in each side unit, one adjustable shelf in TV area and one shelf behind each door. Plain glass in side unit doors.

Delivers in 5 pieces.

c McCoy Wall Unit Entertainment Center

108½" w x 20½" d x 76" h OI350

TV Area: 58" w x 17" d x 49½" h,
TV is 23½" off floor

Glass Door Area: 18" w x 16½" d x 49" h
Base Door Areas: 17¼" w x 16½" d x 15½" h

Features four drawers with media storage, three adjustable shelves in each side unit, one adjustable shelf in TV area and one shelf behind each door. Plain glass in side unit doors.

Delivers in 5 pieces.

d Prairie Mission Wall Unit Entertainment Center

109¾" w x 19¾" d x 74½" h OI300PM*

TV Area: 58" w x 17" d x 47¾" h,
TV is 25" off floor

Glass Door Area: 21¾" w x 17" d x 48½" h
Base Door Areas: 18" w x 17" d x 18" h

Features four drawers with media storage, three adjustable shelves in each side unit, one adjustable shelf in TV area and one shelf behind each door. Plain glass in side unit doors.

Delivers in 5 pieces.

*Not available with beveled glass option.



a



b



c



d



e



f



g



h



i

LIVE ENTERTAINMENT

- a Aspen Media Storage Cabinet with Inlay**
 30" w x 20" d x 36½" h LEASP-H26D
 Area behind door: 21" w x 17" d x 26¼" h
 Features two adjustable shelves
- b Classic Media Storage Cabinet**
 25½" w x 19½" d x 34½" h LECLA-H26D
 Area behind door: 21" w x 17" d x 28¾" h
 Features two adjustable shelves
- c Justine Media Storage Cabinet**
 27½" w x 19" d x 36½" h LEJUS-H26D
 Area behind door: 21" w x 17" d x 26¼" h
 Features two adjustable shelves

- d Loft Media Storage Cabinet**
 29" w x 19" d x 36¼" h LELFT-H26D
 Area behind door: 21" w x 17" d x 29¼" h
 Features two adjustable shelves
- e McCoy Media Storage Cabinet**
 30" w x 19½" d x 36¼" h LEMCC-H26D
 Area behind door: 21" w x 17" d x 28¾" h
 Features two adjustable shelves
- f Prairie Mission Media Storage Cabinet**
 24¾" w x 19½" d x 36¼" h LEPMS-H26D*
 Area behind door: 21" w x 17" d x 29" h
 Features two adjustable shelves

- g Shaker Media Storage Cabinet**
 25½" w x 18¾" d x 36¼" h LESHA-H26D
 Area behind door: 21" w x 17" d x 29½" h
 Features two adjustable shelves
- h Prairie Mission Component Cabinet**
 22¾" w x 22" d x 56¼" h GWPM1000S*
 Glass door area: 19" w x 19" d x 32¾" h
 Features three adjustable shelves behind glass door and one adjustable shelf behind wood door.
- i Prairie Mission Audio Cabinet**
 30½" w x 21" d x 48" h TVPMAC*
 Interior area: 19¼" w x 18½" d x 41" h
 Features two adjustable shelves

*Not available with beveled glass option.

MEDIA UNITS

STYLE YOUR OWN



SHOWN IN CHARACTER CHERRY, BOURBON

STEP 1 | CHOOSE CASE

*Size does not include top and feet.



- Media Unit, 60"**
59" w x 18" d x 23" h* LEK41C
Center: 20½" w x 17" d x 20" h; Doors: 18" w x 17" d x 20" h

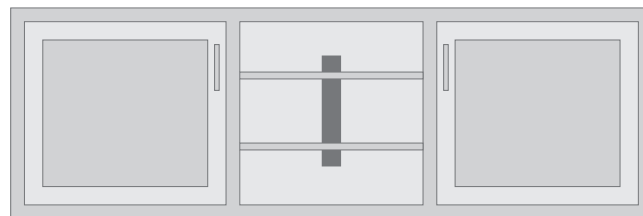

- Media Unit, 72"**
71" w x 18" d x 23" h* LEK41E
Center: 20½" w x 17" d x 20" h; Doors: 24" w x 17" d x 20" h

STEP 2 CHOOSE TOP

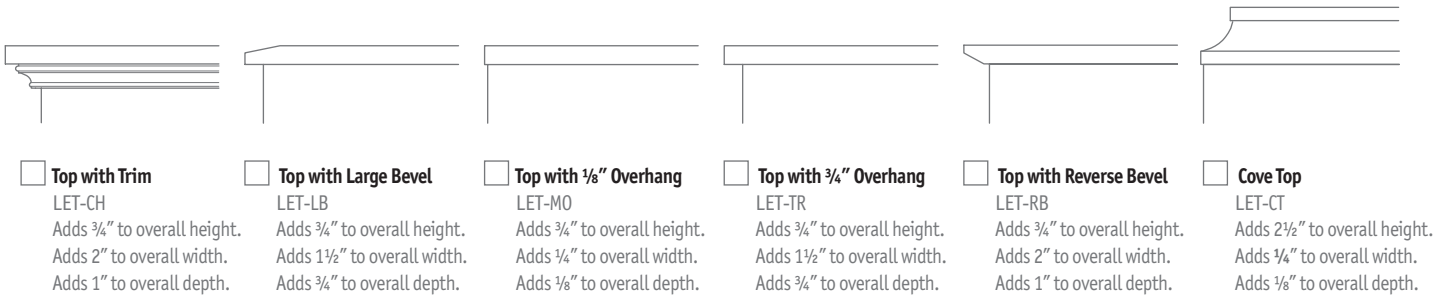

STEP 3 CHOOSE INSET DOOR FRONT

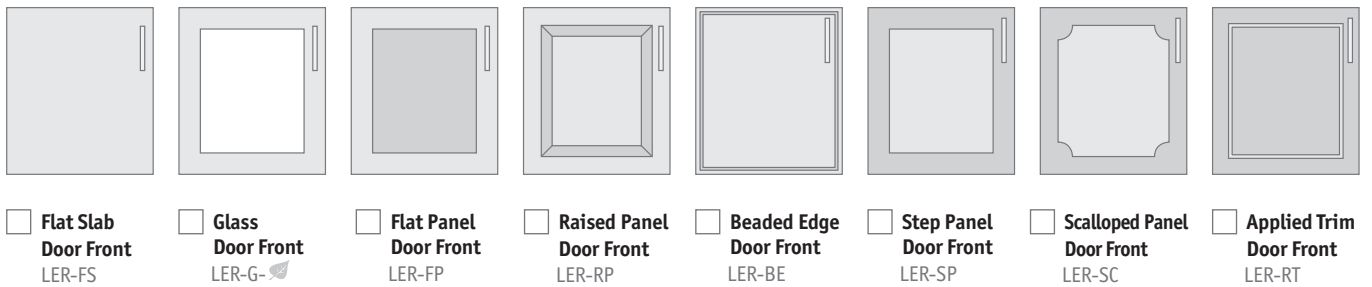

STEP 4 CHOOSE LEG

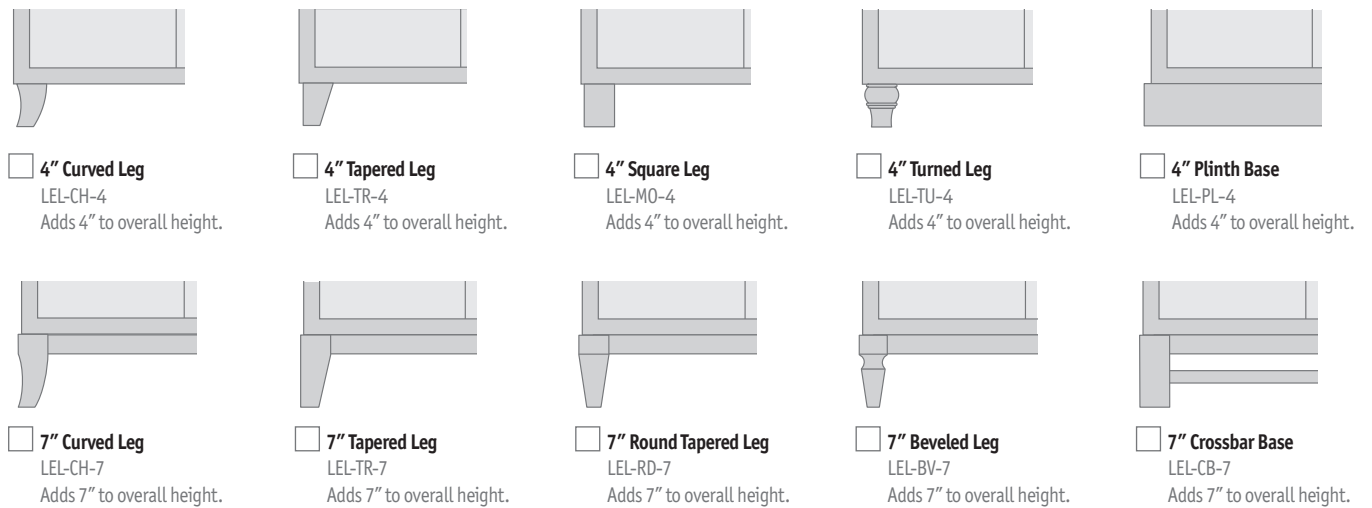

STEP 5 CHOOSE HARDWARE

Level A hardware is standard. See page 25 for complete selection.

Variety is the spice of life!

With five different styles of glass to choose from, your selection can dramatically impact the look and feel of your furniture.



Plain - GP



Beveled - GB

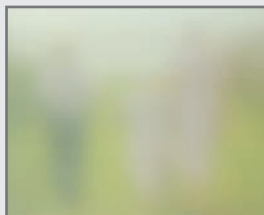

Frosted - GF



Water - GW



Antique - GA

CONSOLE CABINET

STYLE YOUR OWN



SHOWN IN CHARACTER CHERRY, BOURBON

STEP 1 | CHOOSE CASE

*Size does not include top and feet.

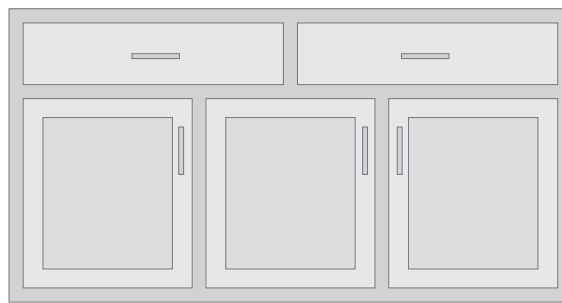

SYO Inset Console Cabinet

54" w x 15" d x 30" h L040A-1A

60" w x 15" d x 30" h L040A-2A

STEP 2 | CHOOSE TOP

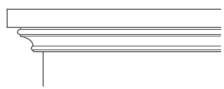

Top with Trim

EST-CH

Adds 3/4" to overall height.
Adds 2" to overall width.
Adds 1" to overall depth.



Top with Large Bevel

EST-LB

Adds 3/4" to overall height.
Adds 1 1/2" to overall width.
Adds 3/4" to overall depth.



Top with 1/8" Overhang

EST-MO

Adds 3/4" to overall height.
Adds 1/4" to overall width.
Adds 1/8" to overall depth.



Top with 3/4" Overhang

EST-TR

Adds 3/4" to overall height.
Adds 1 1/2" to overall width.
Adds 3/4" to overall depth.



Top with Reverse Bevel

EST-RB

Adds 3/4" to overall height.
Adds 2" to overall width.
Adds 1" to overall depth.



Cove Top

EST-CT

Adds 2 1/2" to overall height.
Adds 1/4" to overall width.
Adds 1/8" to overall depth.

STEP 3 CHOOSE INSET DRAWER FRONT



Flat Slab
ESS-FS

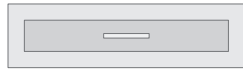

Flat Panel
ESS-FP



Raised Panel
ESS-RP



Applied Trim
ESS-RT



Beaded Edge
ESS-BE



Step Panel
ESS-SP



Scalloped Panel
ESS-SC

STEP 4 CHOOSE INSET DOOR FRONT

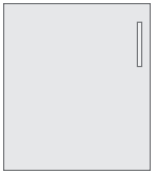

Flat Slab
Door Front
ESR-FS



Glass
Door Front
ESR-G-

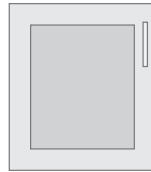

Flat Panel
Door Front
ESR-FP

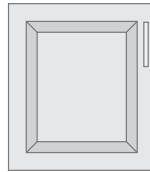

Raised Panel
Door Front
ESR-RP



Beaded Edge
Door Front
ESR-BE

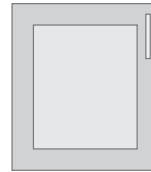

Step Panel
Door Front
ESR-SP

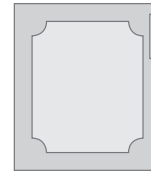

Scalloped Panel
Door Front
ESR-SC

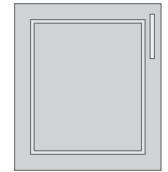

Applied Trim
Door Front
ESR-RT

STEP 5 CHOOSE LEG

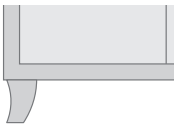

4" Curved Leg
ESL-CH-4
Adds 4" to overall height.

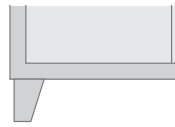

4" Tapered Leg
ESL-TR-4
Adds 4" to overall height.

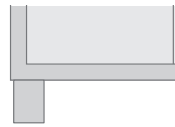

4" Square Leg
ESL-MO-4
Adds 4" to overall height.

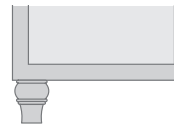

4" Turned Leg
ESL-TU-4
Adds 4" to overall height.



4" Plinth Base
ESL-PL-4
Adds 4" to overall height.

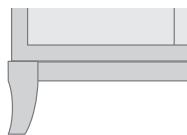

7" Curved Leg
ESL-CH-7
Adds 7" to overall height.

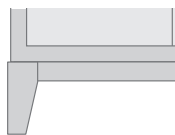

7" Tapered Leg
ESL-TR-7
Adds 7" to overall height.

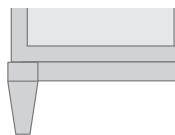

7" Round Tapered Leg
ESL-RD-7
Adds 7" to overall height.

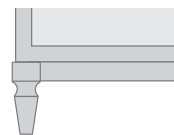

7" Beveled Leg
ESL-BV-7
Adds 7" to overall height.

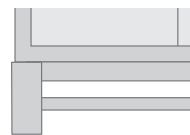

7" Crossbar Base
ESL-CB-7
Adds 7" to overall height.

STEP 6 CHOOSE HARDWARE

Level A hardware is standard. See page 25 for complete selection.

Variety is the spice of life!

With five different styles of glass to choose from, your selection can dramatically impact the look and feel of your furniture.



Plain - GP



Beveled - GB

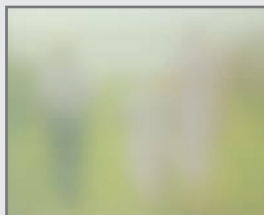

Frosted - GF



Water - GW



Antique - GA

SEATING

LIVE



SHOWN IN CHERRY, MOCHA NUT

Nothing to Hide. Frankly, we don't mind when folks check us out from behind. Because we know exactly what they'll see — the same quality touches that have made Simply Amish a brand that's synonymous with exceptional furniture design.

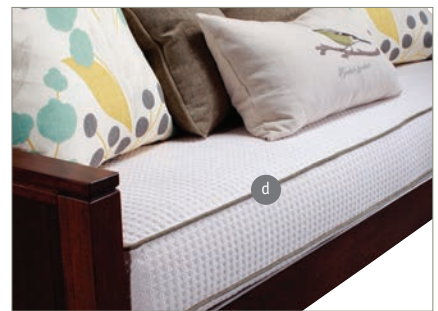
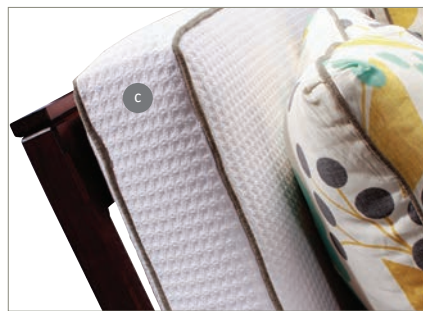

Available options

Simply Amish sofas come with a variety of options:

- a 2-Cushion Back
- b Bench Seat
- c Boxed Cushions
- d Contrasting welt

Sitting is believing. When it comes to seating, we focus heavily in a spot that most folks never see. It's called the deck, and at Simply Amish it's built strong and reinforced for comfort and years of reliable use, providing more upside for your backside. You'll find these features on all non-reclining and stationary seating selections.



- a Each deck surface features a strong denim central panel, surrounded by matching cushion fabric.
- b Underneath the deck, heavy gauge springs are fastened with clips front-to-back, providing comfort and durability.
- c A thick foam core above the springs offers luxurious comfort, while a black cambric bottom provides a barrier against dust.

Qualux Ultra. The Qualux® Ultra Cushion is considered the best seating foam available in the upholstery industry. Resilient when compressed, Qualux Ultra provides exceptional support and increased uniformity from cushion to cushion. And because of its superior quality, it's backed by a limited lifetime warranty. See page 2 for more details.

-
- d The cushion core's high support provides years of comfortable support.
 - e Polyester fiber offers extra support, along with a luxurious crown.
 - f Qualux super-soft polyurethane adds to your seating comfort.



Aspen

See chart below for how many yards of fabric to supply if using your own fabric.

Sofa		Loveseat		Chair		Ottoman
Standard	Recliner	Standard	Recliner	Standard	Recliner	
10	12	7	8	4	4	1½

a Aspen Easy Chair with Inlay

32" w x 36" d x 38" h; Arms: 24" LFAC102-

Features a stationary back.

b Aspen Ottoman with Inlay

29¼" w x 19" d x 14" h; Arms: 24" LFA0103-

c Aspen Recliner with Inlay

32½" w x 38" d x 39½" h



AJAR-

Aspen Wallhugger Recliner with Inlay

(Not shown)

32½" w x 41" d x 39½" h

LCASP-13-

d Aspen Loveseat with Inlay

54¼" w x 36" d x 38" h; Arms: 24" LFAL101-

Features a stationary back.

Aspen Loveseat Recliner with Inlay

(Not shown)

62½" w x 38" d x 39½" h

AJALSR-

Features two wallhugger recliners.

e Aspen Sofa with Inlay

77" w x 36" d x 38" h; Arms: 24" LFAS100-

Features a stationary back.

Aspen Sofa Recliner with Inlay

(Not shown)

88" w x 38" d x 39½" h

AJARS-

Features a wallhugger recliner on either side of stationary center.

Available with fabric or leather cushions. COM = Grade 3.



a



b



c

B&O Railroad® Trestle Bridge

See chart below for how many yards of fabric to supply if using your own fabric.

Sofa	Loveseat	Chair	
Standard	Standard	Standard	Recliner
10	7	4	4

a B&O Railroad® Trestle Bridge Easy Chair
 29¼" w x 40¾" d x 38" h; Arms: 24" LCTRB-05-

Features a stationary back.

b B&O Railroad® Trestle Bridge Recliner
 30" w x 38" d x 39½" h LCTRB-06-

B&O Railroad® Trestle Bridge Wallhugger Recliner (Not shown)
 30" w x 41" d x 39½" h LCTRB-13-

c B&O Railroad® Trestle Bridge Sofa
 74¼" w x 40¾" d x 34½" h LCTRB-01-

B&O Railroad® Trestle Bridge Loveseat (Not shown)
 51¾" w x 40¾" d x 34½" h LCTRB-03-

Features a stationary back.
 Pillows not included.

Available with fabric or leather cushions. COM = Grade 3.

Motorized Power Option Available.



a



b

c



Back

d

See chart below for how many yards of fabric to supply if using your own fabric.

Sofa		Loveseat		Chair		Ottoman
Standard	Recliner	Standard	Recliner	Standard	Recliner	
10	12	7	8	4	4	1½

a MäKayla Recliner ⚡
36¼" w x 41½" d x 41" h AJMAR-⚡

MäKayla Wallhugger Recliner ⚡
40¼" w x 44½" d x 41" h LCMKY-13-⚡

MäKayla Loveseat Recliner ⚡
(Not Shown)
66½" w x 41½" d x 41" h AJMALSR-⚡

Features two wallhugger recliners.

MäKayla Sofa Recliner ⚡ (Not Shown)
92" w x 41½" d x 41" h AJMARS-⚡

Features a wallhugger recliner on either side of a stationary center.

b MäKayla Easy Chair
34¾" w x 40¼" d x 37¾" h LFMAC102-⚡

c MäKayla Ottoman
34" w x 21" d x 14¾" h LFMA0103-⚡

d MäKayla Sofa
79¾" w x 40½" d x 36" h LFMAS100-⚡

Pillows not included.

MäKayla Loveseat (Not Shown)
57½" w x 40¼" d x 37¾" h LFMAL101-⚡

⚡ Available with fabric or leather cushions. COM = Grade 3.

Our wallhugger feature comes standard on all loveseat and sofa recliners, allowing you to recline just 5" from the wall.

This feature is available for recliners as well. Please see the price list for additional information.



Wallhugger Recliner



Standard Recliner



a

Grand Rapids

See chart below for how many yards of fabric to supply if using your own fabric.

Chair	
Standard	Recliner
4	4



b



c

Loveseat	
Standard	Recliner
7	8



d



e

Sofa	
Standard	Recliner
10	12



f

LIVE SEATING

a Grand Rapids Easy Chair
32" w x 36 3/4" d x 36" h LFGC102-
Features a stationary back.

b Grand Rapids Recliner
32 1/2" w x 38" d x 39 1/2" h AJHLR-

Grand Rapids Wallhugger Recliner (Not shown)
36 1/2" w x 41" d x 39 1/2" h LCGRD-13-

c Grand Rapids Loveseat
54 1/4" w x 37" d x 36" h LFG101-
Features a stationary back.

d Grand Rapids Loveseat Recliner
62 1/2" w x 38" d x 39 1/2" h AJSKLSR-
Features two wallhugger recliners.

e Grand Rapids Sofa
76 1/2" w x 37" d x 36" h LFGS100-
Features a stationary back.

f Grand Rapids Sofa Recliner
88" w x 38" d x 39 1/2" h AJGRS-
Features a wallhugger recliner on either side of stationary center.

Available with fabric or leather cushions. COM = Grade 3.

Motorized Power Option Available.

simplyamish

EXPRESS

SEATING

353



a



b

c



d



Back

Justine

See chart below for how many yards of fabric to supply if using your own fabric.

Sofa	Loveseat	Chair		Ottoman
Standard	Standard	Standard	Recliner	
10	7	4	4	1½

- a Justine Rectiner** ⚡
27½" w x 35" d x 37" h LCJUS-06-☞
Justine Wallhugger Recliner (Not shown)
27.5" w x 35" d x 37" h LCJUS-13-☞

- b Justine Easy Chair**
27" w x 35" d x 37" h LSJSC-☞
Pillow not included.

- c Justine Ottoman**
24" w x 17½" d x 14½" h LSJSO-☞

- d Justine Sofa**
72¼" w x 36½" d x 37" h LSJSS-☞
Pillows not included.
Justine Loveseat (Not shown)
50" w x 36½" d x 37" h LSJSL-☞

☞ Available with fabric or leather cushions. COM = Grade 3.



a



b



c

d



e

McCoy

See chart below for how many yards of fabric to supply if using your own fabric.

Sofa	Loveseat	Chair		Ottoman
Standard	Standard	Standard	Recliner	
10	7	4	4	1½

a McCoy Recliner ⚡

33" w x 38" d x 41" h

AJMCR- ⚡

McCoy Wallhugger Recliner

33" w x 41" d x 41" h

LCMCC-13- ⚡

b McCoy Rocker/Recliner

33" w x 42" d x 42" h

AJMCR- ⚡

c McCoy Easy Chair

31¾" w x 36½" d x 36" h

LFMCC102- ⚡

d McCoy Ottoman

29" w x 19" d x 14" h

LFMCO103- ⚡

e McCoy Sofa

76¾" w x 36½" d x 35½" h LFMCS100- ⚡

McCoy Loveseat (Not shown)

54¾" w x 36½" d x 35½" h LFMCL101- ⚡

⚡ Available with fabric or leather cushions. COM = Grade 3.



Morris

See chart below for how many yards of fabric to supply if using your own fabric.

Sofa	Loveseat	Chair	Ottoman
Standard	Standard	Standard	
10	7	4	1½

a Morris Chair
 32¾" w x 39" h AJBAMC-
 Features adjustable back with peg stops.

b Morris Ottoman
 20" w x 16" d x 14½" h AJBAFS-

c Morris Easy Chair
 31¾" w x 38¾" d x 36" h LFMOC102-
 Features a stationary back.

d Morris Loveseat
 54¾" w x 38¾" d x 36" h LFMOL101-
 Features a stationary back.

e Morris Sofa
 76½" w x 38¾" d x 36" h LFMOS100-
 Features a stationary back.

Available with fabric or leather cushions. COM = Grade 3.

Our wallhugger feature comes standard on all loveseat and sofa recliners, allowing you to recline just 5" from the wall.

This feature is available for recliners as well. Please see the price list for additional information.



Wallhugger Recliner



Standard Recliner



a

b

Prairie Mission

See chart below for how many yards of fabric to supply if using your own fabric.

Chair	Ottoman
Standard	
4	1½

a Prairie Mission Lounge Glider

32" w x 30" d x 41½" h LFPMLG-

b Prairie Mission Lounge Ottoman

31" w x 17½" d x 13¾" h LFPMLO-

Available with fabric cushion seat or leather cushion seat. COM = Grade 3.



a B&O Railroad® Trestle Arm Rocker
24" w x 32½" d x 38½" h LCTRB-53-🍃

b Bentback Arm Rocker
24" w x 30" d x 39" h YMBBAR-W
Not available in quartersawn white oak.
Not available with seat cushion.

c Bentwood Rocker ⇄
Available in Cherry and Oak.
22" w x 29" d x 41" h
Cherry QSC-AP8001BOR
Oak QSO-AP8001BOR

d Big Daisy Rocker ⇄ ⇄
26" w x 32" d x 42" h KSBDR-W
Not available in walnut.
Not available with seat cushion.

e Newton Rocker
25" w x 31" d x 46½" h SANER-🍃
Not available in walnut.

f Oakland Panel Rocker
29" w x 46" h DEOPR-🍃
Not available in walnut.

g Oakland Slat Rocker
29" w x 46" h DEOSR-🍃
Not available in walnut.

🍃 Available with wood seat, fabric cushion seat, or leather cushion seat. COM = Grade 3.



a

b

c

d



e

f

g

a Urbandale Arm Rocker

24" w x 39" h (Seat Height: 17½") KSUAR-🍃

b Urbandale II Arm Rocker ⇌ ⇌

24" w x 39" h (Seat Height: 17½") KSUIIAR-🍃

c Urbandale Arm Glider(Shown with leather cushion seat)
27½" w x 27½" d x 40" h KSUG-🍃**d Urbandale Glider Ottoman** ⇌ ⇌

21" w x 21" d x 15" h KSUG0-🍃

e Urbandale II Arm Glider ⇌ ⇌(Shown with leather cushion seat)
27½" w x 27½" d x 40" h KSUIIG-🍃**f Oak Park Glider**28" w x 21" d x 47½" h
Not available in walnut. DESTG-🍃**g Newton Glider**25" w x 27½" d x 46" h
Not available in walnut. DEAG-🍃

🍃 Available with wood seat, fabric cushion seat, or leather cushion seat. COM = Grade 3.



EXPRESS



QUICKSHIP

simplyamish

SOFA EXTENSION TABLES

STYLE YOUR OWN



SHOWN WITH TAPERED LEGS, SMALL ROUND-OVER EDGE, IN OAK, DRIFTWOOD

STEP 1 | SELECT SIZE

Only available with Square Corner shape.

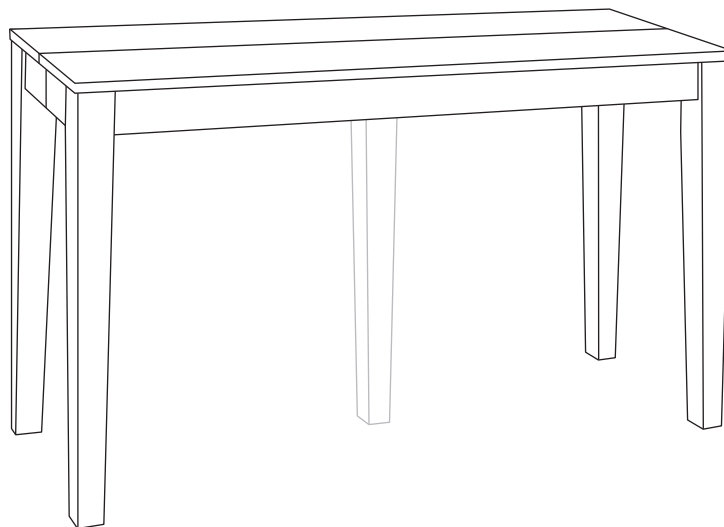

- 48" w x 16" d** LOSSD-42I50
Features removable center leg and four 20" leaves with telescoping slides.
Extends to 96" deep with all leaves in place.

STEP 2 | CHOOSE EDGE



Large Roundover LOTE-10

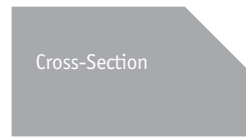

Small Bevel LOTE-30

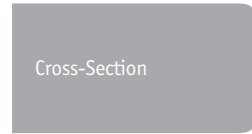

Small Roundover LOTE-40



Lipped LOTE-50



Large Bevel LOTE-60

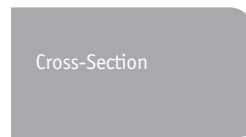

Medium Roundover LOTE-80

STEP 3 | CHOOSE LEG



a



b



c



d

a Loft II

table height LOL-SC30

b Small Square

table height LOL-SE30

c Small Square-Tapered

table height LOL-SS30

d Turned

table height LOL-TL30

OCCASIONAL TABLES

LIVE



SHOWN IN CHARACTER CHERRY, HAZELNUT



End those my end table is too high or low blues.

We've added an option that allows you to increase or reduce the overall height of your end table, chair side, coffee, or sofa table up to 6" either way, in ½" increments. Please see the price list for more information.



Lift. Eat. Repeat.

Too lazy to reach for the nachos? Let our convenient lift-top tables bring your favorite snack to you. Available on many of our most popular coffee tables, this convenient feature quickly raises the surface from 18" to 30".



a



b



c



d



e



f



g





h

12" butterfly leaf



a Aaralyn Coffee Table 
 36" w x 18" d x 18" h LWA1836CT
 42" w x 22" d x 18" h LWA2242CT

b Aaralyn End Table 
 18" w x 22" d x 22" h LWAET

c Aaralyn Lamp Table 
 17" w x 13" d x 27" h LWALT

d Aaralyn Sofa Table 
 36" w x 13" d x 27" h LWAST

e Alexandria Coffee Table
 54" w x 30" d x 18" h LOALE-02A0

f Alexandria End Table
 26" w x 22" d x 22" h LOALE-06A0

g Alexandria Sofa Table
 54" w x 18" d x 29" h LOALE-13A0

h Alexandria Sofa/Dining Table
 54" w x 18" d x 30" h LOALE-20A0
 60" w x 18" d x 30" h LOALE-20A08
 Features a 12" stationary butterfly leaf,
 table becomes 54" x 30" with leaf in.



a



b



c



d



e

Lift Top Available



f

Lift Top Available



g



h



i



j

a Anne Marie Coffee Table

36" w x 18" d x 18" h LW1836CT
42" w x 22" d x 18" h LW2242CT

b Anne Marie End Table

18" w x 22" d x 22" h LWET

c Anne Marie Lamp Table

17" w x 13" d x 27" h LWLT

d Anne Marie Sofa Table

36" w x 13" d x 27" h LWST

e Aspen Coffee Table with Inlay

42" w x 22" d x 19" h LOASP-02A12
48" w x 27" d x 19" h ECA700C
54" w x 30" d x 19" h LOASP-02A07

Lift top

48" w x 27" d x 19" h ECA745LT

f Aspen Square Coffee Table with Inlay

36" w x 36" d x 19" h ECA710C
42" w x 42" d x 19" h LOASP-02E12

Lift top

36" x 36" x 19" h ECA750LT

g Aspen Telephone Table with Inlay

24" w x 18" d x 28½" h ECA740T

h Aspen End Table with Inlay

24" w x 26" d x 22½" h ECA730E

i Aspen 1-Drawer End Table with Inlay

24" w x 26" d x 22½" h ECA735E

j Aspen Chair Side Table with Inlay

16" w x 26" d x 22" h ECACST



a



b



c



d

a Aspen Sofa Table with Inlay

48" w x 16" d x 28½" h

ECA715S

60" w x 16" d x 28½" h

ECA720S

b Aspen 1-Drawer Sofa Table with Inlay

48" w x 16" d x 28½" h

ECA718S

60" w x 16" d x 28½" h

ECA723S

c Aspen 1-Drawer Console Table with Inlay

36" w x 16" d x 30½" h

ECA725C

d Aspen Console Bar Table, 72"

72" w x 18" d x 36" h

LOASP-39C4A

Shown with**Aspen Backless Swivel Barstool with Inlay** 

16" w x 16" d x 24" h

ECASP-06C-W

Barstools sold separately.



360° SWIVEL

simplyamish



Two Auburn Bay Tuck Away Coffee Tables (a) shown tucked beneath an Auburn Bay Coffee Table (b).



b



c



d



e

a Auburn Bay Tuck Away Coffee Table

15½" w x 20" d x 14½" h LOABR-35C4A
 Fits into Auburn Bay Coffee Table without a shelf.
 Features 2" thick top.

b Auburn Bay Coffee Table

42" w x 22" d x 18" h LOABR-25C43
 54" w x 24" d x 18" h LOABR-25C4A
 54" w x 30" d x 18" h, Extra Deep LOABR-25C4B
 Features 2" thick top.

c Auburn Bay End Table with Shelf

16" w x 24" d x 24" h LOABR-34A3A
 22" w x 24" d x 24" h LOABR-34A4A
 Features 2" thick top.

d Auburn Bay Sofa Table

48" w x 16" d x 28¼" h LOABR-31C0
 60" w x 16" d x 28¼" h LOABR-31C1
 72" w x 16" d x 28¼" h LOABR-31C2
 Features 2" thick top.

e Auburn Bay Console Bar Table, 72"

72" w x 18" d x 36" h LOABR-39C4A

**Shown with
 Sheffield Backless Stationary Barstool**

16" w x 16" d x 24" h ECSHE-08C-
 Barstools sold separately.

Available with wood seat, fabric cushion seat or leather cushion seat. If using your own fabric please supply ½ yard. COM = Grade 3.



a



b



c



d



12" butterfly leaf

e

a Avalon Coffee Table

42" w x 22" d x 18½" h LOAVA-13A12
 48" w x 24" d x 18½" h LOAVA-13A06
 54" w x 29¾" d x 18½" h LOAVA-13A0

Features 1½" top.

b Avalon Round Coffee Table

36" dia x 18¼" h LOAVA-02I05
 42" dia x 18¼" h LOAVA-02I12
 48" dia x 18¼" h LOAVA-02I0

Features 1½" top.

c Avalon End Table

24" High
 24" dia x 24" h LOAVA-06L0
 30" dia x 24" h LOAVA-06M0

30" High
 24" dia x 30" h LOAVA-06N0
 32" dia x 30" h LOAVA-06I0

Features 1½" top.

d Avalon Sofa Table

54" w x 18" d x 30½" h LOAVA-02A0
 60" w x 18" d x 30½" h LOAVA-02A08
 Features 1½" top.

e Avalon Sofa/Dining Table

54" w x 18" d x 29½" h LOAVA-18A0
 60" w x 18" d x 29½" h LOAVA-18A08
 Features 1" top and 12" butterfly leaf.

B&O Railroad® Collection

Inspired by the pioneering days of the great western expansion that was powered by the railroads of the time.



a



b



c



d



e



f

a B&O Railroad® Trestle Bridge Coffee Table

42" w x 22" d x 18 1/4" h LOTRB-02A12
 54" w x 30" d x 18 1/4" h LOTRB-02A0 
 Lift top (Inset)
 54" w x 30" d x 18 1/4" h LOTRB-02B0

b B&O Railroad® Trestle Bridge Square Coffee Table

36" w x 36" d x 18 1/2" h LOTRB-02E0
 42" w x 42" d x 18 1/2" h LOTRB-02E12

c B&O Railroad® Trestle Bridge Round Coffee Table

36" w x 36" d x 18 1/2" h LOTRB-23C0
 42" w x 42" d x 18 1/2" h LOTRB-23C1
 48" w x 48" d x 18 1/2" h LOTRB-23C2

d B&O Railroad® Trestle Bridge End Table

16" w x 26" d x 21 1/4" h LOTRB-06A14
 22" w x 26" d x 21 1/4" h LOTRB-06A0 

e B&O Railroad® Trestle Bridge Round End Table

24" w x 24" d x 22" h LOTRB-26C0
 30" w x 30" d x 22" h LOTRB-26C1

f B&O Railroad® Trestle Bridge Sofa Table

54" w x 16" d x 29 1/2" h LOTRB-13A0 
 60" w x 16" d x 29 1/2" h LOTRB-13A08

Planked Top Standard. Plank widths will vary.



a



b



c



d



e



f

LIVE OCCASIONAL TABLES

a B&O Railroad® Spike Coffee Table
48"w x 28½"d x 19¼"h LOSPK-02A0

b B&O Railroad® Spike Square Coffee Table
36"w x 36"d x 18¾"h LOSPK-02E0

c B&O Railroad® Spike End Table
23½"w x 26"d x 22"h LOSPK-06A0

d B&O Railroad® Spike Chair Side Table
18"w x 26"d x 21¾ h LOSPK-01A0

e B&O Railroad® Spike Sofa Table
54"w x 17¾"d x 30"h LOSPK-13A0

f B&O Railroad® Console Bar Table, 72"
72"w x 18"d x 36"h LOTRB-39C4A

Shown with
B&O Railroad® Trestle Bridge Backless Stationary Barstool
18"w x 14"d x 24"h ECTRB-08C-
Barstools sold separately.

Planked Top Standard. Plank widths will vary.

 Available with wood seat, fabric cushion seat or leather cushion seat. If using your own fabric please supply ½ yard. COM = Grade 3.



a



b



c



d



e



f



g



h



i

a Bowen Coffee Table

36" w x 18" d x 18" h LWB1836CT
42" w x 22" d x 18" h LWB2242CT

c Bowen Lamp Table

17" w x 13" d x 27" h LWBLT

e Brookfield Coffee Table

48" w x 26" d x 18" h TVBF2648C

g Brookfield End Table

24" dia. x 22" h TVBFRE
30" dia. x 30" h LOBRK-06LO

b Bowen End Table

18" w x 22" d x 22" h LWBET

d Bowen Sofa Table

36" w x 13" d x 27" h LWBST

f Brookfield Round Coffee Table

36" dia. x 18" h TVBFC

h Brookfield Lamp Table

24" dia. x 27" h TVBFRNS

i Brookfield Sofa Table

54" w x 17" d x 27" h TVBFS-54
48" w x 17" d x 27" h TVBFS-48



a



b



c



d



e

12" butterfly leaf

a Charleston Coffee Table

42" w x 22" d x 18½" h

LOCHS-13A12

48" w x 24" d x 18½" h

LOCHS-13A06

54" w x 30" d x 18½" h

LOCHS-13A0

Features 1½" top.

c Charleston End Table

32" dia. x 30" h

LOCHS-06I0

24" dia. x 24" h

LOCHS-06L0

30" dia. x 24" h

LOCHS-06M0

24" dia. x 30" h

LOCHS-06N0

Features 1½" top.

d Charleston Sofa Table

54" w x 18" d x 30" h

LOCHS-02A0

60" w x 18" d x 30" h

LOCHS-02A08

Features 1½" top.

b Charleston Round Coffee Table

36" dia. x 18½" h

LOCHS-02I05

42" dia. x 18½" h

LOCHS-02I0

48" dia. x 18½" h

LOCHS-02I06

Features 1½" top.

e Charleston Sofa/Dining Table

54" w x 18" d x 30" h

LOCHS-18A0

60" w x 18" d x 30" h

LOCHS-18A08

Features 1" top and 12" butterfly leaf.



a



b



c



d



e

a Chesapeake 1-Drawer Coffee Table
48" w x 28" d x 18" h SACPT

b Chesapeake 1-Drawer End Table
22" w x 24" d x 24" h SACPE

c Chesapeake Chair Side Table
16" w x 24" d x 24" h SACPCS

d Chesapeake 1-Drawer Sofa Table
54" w x 16" d x 30" h SACPS

e Classic Sofa Server
12" w x 14" d x 24" h LOCLA-21K



b



c



d

a Crawford Square Coffee Table with Shelf

36" w x 36" d x 17 1/4" h LOCRA-24A0
 42" w x 42" d x 17 1/4" h LOCRA-24A1
 48" w x 48" d x 17 1/4" h LOCRA-24A2

Features 1 1/4" thick top.

b Crawford Coffee Table with Shelf

42" w x 20" d x 17 1/4" h LOCRA-25A0
 48" w x 20" d x 17 1/4" h LOCRA-25A1
 54" w x 26" d x 17 1/4" h LOCRA-25A2

Features 1 1/4" thick top.

c Crawford End Table with Shelf

16" w x 26" d x 24 1/2" h LOCRA-28A3
 22" w x 26" d x 24 1/2" h LOCRA-28A4

Features a hidden drawer and 1 1/4" thick top.

d Crawford Sofa Table with Drawers

54" w x 18" d x 30 1/2" h LOCRA-31C0
 60" w x 18" d x 30 1/2" h LOCRA-31C1

Features 3 hidden drawers and 1 1/4" thick top.

REDESIGNED



a



b



c



d



e



f



g



h

a Dovetail Sofa Server

12" w x 26" d x 24" h LODOV-21K

b Dovetail End Table

16" w x 24" d x 24" h LODOV-28A1A

22" w x 24" d x 24" h LODOV-28A2A

28" w x 28" d x 28" h LODOV-28A3A

c Dovetail Coffee Table

42" w x 24" d x 18" h LODOV-25A1A

54" w x 24" d x 18" h LODOV-25A2A

d Dovetail Sofa Table

54" w x 18" d x 30" h LODOV-31A0A

60" w x 18" d x 30" h LODOV-31A1A

72" w x 18" d x 30" h LODOV-31A2A

e Grace Coffee Table

36" w x 18" d x 18" h LWG1836CT

42" w x 22" d x 18" h LWG2242CT

f Grace End Table

18" w x 22" d x 22" h LWGET

g Grace Lamp Table

17" w x 13" d x 27" h LWGLT

h Grace Sofa Table

36" w x 13" d x 27" h LWGST



a



Fully Open



Back Side



Features a hidden drawer.

b



Features a hidden drawer in each end.

c



Features a hidden drawer in each end.

d

a Greenville Incognito Coffee Table

54" w x 30" d x 18" h LOGRE-25C4A

Rough Sawn Standard.

Features a lift top, two extending compartments, three secret drawers, a hidden compartment in the back, and push to open drawers.

b Incognito End Table

16" w x 26" d x 24" h LOINC-28A3A

20" w x 26" d x 24" h LOINC-28A4A

Features a hidden drawer. Rough Sawn Standard.

c Incognito Sofa Table

54" w x 16" d x 29" h LOINC-31A0A

60" w x 16" d x 29" h LOINC-31A1A

72" w x 16" d x 29" h LOINC-31A2A

Features a hidden drawer in each end.

Rough Sawn Standard.

d Incognito Console Bar Table, 72"

72" w x 18" d x 36" h LOINC-39C4A

Features a hidden drawer in each end.

Rough Sawn Standard.

Shown with

Sheffield Backless Stationary Barstool

16" w x 16" d x 24" h ECSHE-08C-

Barstools sold separately.

Available with wood seat, fabric cushion seat or leather cushion seat. If using your own fabric please supply 1/2 yard. COM = Grade 3.



a

Lift Top Available



b

Lift Top Available



c



d



e

a Hudson Coffee Table

48" w x 23" d x 18" h LOHUD-02C1

Features one drawer.

Lift top version (No Drawer)

48" w x 23" d x 18" h LOHUD-02P1

b Hudson Square Coffee Table

36" w x 36" d x 18" h LOHUD-02E1

Features one drawer.

Lift top version (No Drawer)

36" w x 36" d x 18" h LOHUD-02Q1

c Hudson End Table

22" w x 26" d x 22" h LOHUD-06A1

Features one drawer.

d Hudson Chair Side Table

16" w x 22" d x 22" h LOHUD-01A1

Features one drawer.

e Hudson Sofa Table

48" w x 16" d x 29" h LOHUD-13A1

Features one drawer.



a

LIVE

OCCASIONAL TABLES



b



c



d

a Ironwood Coffee Table

42" w x 22" d x 18" h,
Black Base

LOIRN-25C3A-B
LOIRN-25C3A-C

54" w x 24" d x 18" h,
Black Base

LOIRN-25C4A-B
LOIRN-25C4A-C

54" w x 30" d x 18" h,
Black Base, Extra Deep
Gunmetal Base, Extra Deep
Features 2" Edge Profile.

LOIRN-25C4B-B
LOIRN-25C4B-C

b Ironwood Square Coffee Table

26" w x 26" d x 18½" h,
Black Base
Gunmetal Base
Features 2" Edge Profile.

LOIRN-24C0A-B
LOIRN-24C0A-C

c Ironwood End Table

16" w x 26" d x 24½" h
Black Base
Gunmetal Base
20" w x 26" d x 24½" h
Black Base
Gunmetal Base
Features 2" Edge Profile.

LOIRN-28C3A-B
LOIRN-28C3A-C

LOIRN-28C4A-B
LOIRN-28C4A-C

d Ironwood Sofa Table

48" w x 16" d x 28½" h
Black Base
Gunmetal Base

LOIRN-31C0A-B
LOIRN-31C0A-C

60" w x 16" d x 28½" h
Black Base
Gunmetal Base

LOIRN-31C1A-B
LOIRN-31C1A-C

72" w x 16" d x 28½" h
Black Base
Gunmetal Base
Features 2" Edge Profile.

LOIRN-31C2A-B
LOIRN-31C2A-C



a



b



c



d



e



f

a Justine Coffee Table

42" w x 22" d x 18" h KAJ2242CT
50" w x 30" d x 18" h KAJCT

b Justine Square Coffee Table

34" w x 34" d x 18" h KAJCT34
42" w x 42" d x 18" h KAJCT42

c Justine End Table

16" w x 25³/₄" d x 24" h KAJCT1625E
24" w x 25³/₄" d x 24" h KAJE
Features one drawer

d Justine Chair Side Table

16" w x 26" d x 24" h KAJCST

e Justine Sofa Table

48" w x 14" d x 30" h KAJS
54" w x 14" d x 30" h KAJ54

f Justine Console Bar Table, 72"

72" w x 18" d x 36" h LOJUS-39C4A

Shown with

Sara Stationary Barstool

18" w x 14" d x 24" h ECSRA-04C

Barstools sold separately.

Available with wood seat, fabric cushion seat or leather cushion seat. If using your own fabric please supply 1/2 yard. COM = Grade 3.



LIVE EDGE

OCCASIONAL

LIVE

OCCASIONAL TABLES

Visit *SimplyAmish.com* to see our wide selection of live edge tops and custom bases.

- End Tables
- Side Tables
- Console Tables
- Coffee Tables
- Cocktail Tables and more...

Cut from a single tree, our 1½" thick Live Edge tops are one solid slab of wood with two live edges.

Visit our website to see available completed pieces that are ready to ship.



[SimplyAmish.com/collections/occasional-tables/live-edge](https://www.SimplyAmish.com/collections/occasional-tables/live-edge)



a Lift Top Available



b



12" butterfly leaf



c



d



Lift Top Available



e Lift Top Available



f

a Loft Leg 1-Drawer Coffee Table

42" w x 22" d x 18" h JFCS2242CT
 44" w x 26" d x 18" h JFCSCT

Lift top

44" w x 26" d x 18" h JFCSCT-LT
 No drawer with lift top.

b Loft Leg 1-Drawer End Table

16" w x 26" d x 22" h JFCS1626ET
 20" w x 26" d x 22" h JFCSCT
 20" w x 26" d x 27" h JFCSLT

c Loft Leg 1-Drawer Sofa Table

60" w x 16" d x 29" h JFCS60ST
 48" w x 16" d x 29" h JFCSST

d Loft Sofa/Dining Table

54" w x 18" d x 30" h LOLFT-19A0
 60" w x 18" d x 30" h LOLFT-19A08

Features a 12" stationary butterfly leaf, table becomes 54" x 30" with leaf.

e Loft Coffee Table

42" w x 22" d x 18" h LOLFT-02A0
 48" w x 26" d x 18" h NOLOCT

Lift top

42" w x 22" d x 18" h LOLFT-02B0
 48" w x 26" d x 18" h NOLOCT-LT

f Loft Square Coffee Table

36" w x 36" d x 18" h NOLOSC
 42" w x 42" d x 18" h LOLFT-02E12

Lift top

36" w x 36" d x 18" h NOLOSC-LT



a



b



c



d



e

a Loft End Table
 16" w x 26" d x 22" h
 22" w x 26" d x 22" h

NOLOES
 NOLOET



b Loft Sofa Table
 48" w x 16" d x 30" h
 60" w x 16" d x 30" h

NOLOST
 LOLFT-13A08

c Loft Cabinet End Table
 22" w x 26" d x 22" h
 NOLO2226E
 Features open space behind doors.

d Loft II Round End Table
 24" dia. x 22" h
 TVL24RE

e Loft Console Bar Table, 72"
 72" w x 18" d x 36" h
 LOLFT-39C4A

Shown with
Portland Swivel Barstool 
 16" w x 16" d x 24" h
 ECPTL-14C 
 Barstools sold separately.

 Available with wood seat, fabric cushion seat or leather cushion seat. If using your own fabric please supply 1/2 yard. COM = Grade 3.



- a Logan Coffee Table**
 36" w x 18" d x 18" h LWL1836CT
 42" w x 22" d x 18" h LWL2242CT
- b Logan End Table**
 18" w x 22" d x 22" h LWLET
- c Logan Lamp Table**
 17" w x 13" d x 27" h LWLLT
- d Logan Sofa Table**
 36" w x 13" d x 27" h LWLST

- e MäKayla Coffee Table**
 42" l x 22" d x 18 1/4" h TVM2242CD
 48" l x 26" d x 18 1/4" h TVM2648CD
 54" l x 30" d x 18 1/4" h TVM3054CD
 Features two Secret Drawers
- f MäKayla Square Coffee Table**
 36" w x 36" d x 18 1/4" h TVM3636SCD
 42" w x 42" d x 18 1/4" h TVM4242SCD
 Features a Secret Drawer

- g MäKayla End Table**
 20" w x 26" d x 22 1/4" h TVM2026ED
 Features a Secret Drawer
- h MäKayla Chair Side Table**
 16" w x 26" d x 22 1/4" h TVM1626CSD
- i MäKayla Sofa Table**
 60" l x 18" d x 27 1/2" h TVM1860SD
 Features two Secret Drawers



- a Marshall Coffee Table**
 - 36" w x 18" d x 18" h LWM1836CT
 - 42" w x 22" d x 18" h LWM2242CT
- b Marshall End Table**
 - 18" w x 22" d x 22" h LWMET
- c Marshall Lamp Table**
 - 17" w x 13" d x 27" h LWMLT
- d Marshall Sofa Table**
 - 36" w x 13" d x 27" h LWMST

- e Metropolis Coffee Table**
 - 42" w x 22" d x 18" h KAMA2242CT
 - 48" w x 24" d x 18" h KAMACT
 - 54" w x 30" d x 18" h KAMA3054CT
- f Metropolis Square Coffee Table**
 - 36" w x 36" d x 18" h KAMA3636SCT
 - 42" w x 42" d x 18" h KAMASCT

- g Metropolis End Table**
 - 16" w x 26" d x 24" h KAMA1626ET
 - 24" w x 28" d x 24" h KAMAET
- h Metropolis Sofa Table**
 - 54" w x 18" d x 30" h KAMAST
 - 60" w x 18" d x 30" h KAMA60ST



a

Lift Top Available



b



c



d



e



f



g



h

a McCoy Cabinet Coffee Table

42" w x 22" d x 18" h MAMC2242

Lift top

42" w x 22" d x 18" h MAMC2242LT

Features open space behind doors.

b McCoy 1-Drawer Coffee Table

48" w x 28" d x 17½" h MAMCOC

c McCoy Cabinet End Table

20" w x 22" d x 24" h MAMC2022

Features open space behind door.

d McCoy 1-Drawer End Table

23" w x 26" d x 24" h MAMCOE

e McCoy 1-Door Cabinet Chair Side Table

16" w x 22" d x 24" h MAMC1626CS

Features open space behind door.

f McCoy 1-Drawer Chair Side Table

16" w x 26" d x 24" h MAMC01626E

g McCoy Cabinet Sofa Table

48" w x 16" d x 29½" h MAMC1648

Features one fixed shelf behind doors.

h McCoy 1-Drawer Sofa Table

54" w x 16" d x 29¼" h MAMCOS



a Each sold separately.



b Lift Top Available



c Lift Top Available



d



e



f



g

a Mission Plant Stand

13" w x 13" d x 14" h JFM14S
 13" w x 13" d x 20" h JFM20S
 13" w x 13" d x 26" h JFM26S
 13" w x 13" d x 33" h JFM33S

b Mission Coffee Table

46" w x 23" d x 18 1/4" h IW2346MCS

Lift top

46" w x 23" d x 18 1/4" h IW2346LTCS

c Mission Square Coffee Table

36" w x 36" d x 18 1/4" h IW3636MC

Lift top

36" w x 36" d x 18 1/4" h IW3636LTMC

d Mission 1-Drawer End Table

19 1/4" w x 25 1/4" d x 22" h IW1925MED

e Mission End Table

19 1/4" w x 25 1/4" d x 22" h IW1925MES

f Mission 1-Drawer Chair Side Table

16" w x 24" d x 22" h IW1625MCT

g Mission Sofa Table

48" w x 16" d x 29" h IW1648MSS

60" w x 16" d x 29" h IW1660MSS



a



b



c



d



e

12" butterfly leaf

a Montauk Coffee Table

Rough Sawn & Plank Top Standard*

42" w x 22" d x 19" h LOMOK-25C0A
 48" w x 24" d x 19" h LOMOK-25C1B
 54" w x 30" d x 19" h LOMOK-25C2C

b Montauk End Table

Rough Sawn & Plank Top Standard*

16½" w x 24" d x 25½" h LOMOK-28C0A
 22" w x 26" d x 25½" h LOMOK-28C1B

c Montauk Round End Table

Rough Sawn & Plank Top Standard*

24" w x 24" d x 25½" h LOMOK-26C1A

d Montauk Sofa Table

Rough Sawn & Plank Top Standard*

54" w x 18" d x 30½" h LOMOK-31C1A
 60" w x 18" d x 30½" h LOMOK-31C2A

e Montauk Sofa Dining Table

Rough Sawn & Plank Top Standard*

54" w x 18" d x 30" h LOMOK-20A07
 60" w x 18" d x 30" h LOMOK-20A08

*Planking is varied widths.



a



b



c



d



e

Lift Top Available



f



g



h

a Park Avenue 1-Drawer Open Coffee Table
48" w x 28" d x 19" h MAPAOC

b Park Avenue 1-Drawer Open End Table
22" w x 24" d x 24" h MAPAO2224E

c Park Avenue 1-Drawer Open Chair Side Table
16" w x 24" d x 24" h MAPAO1624E

d Park Avenue 1-Drawer Open Sofa Table
54" w x 18" d x 30" h MAPAOS

e Park Avenue Cabinet Coffee Table
43" w x 24" d x 19" h MAPAC

Lift top

43" w x 24" d x 19" h MAPAC-LT

Features open space behind doors.

f Park Avenue Cabinet End Table
22" w x 24" d x 24" h MAPAE
Features open space behind door.

g Park Avenue Cabinet Chair Side Table
16" w x 24" d x 24" h MAPACST

Features open space behind door.

h Park Avenue Cabinet Sofa Table
54" w x 18" d x 30" h MAPAS

Features one fixed shelf behind doors.



a



b



c



d



e



f

a Parkdale Nesting Table

24" w x 20" d x 24½" h
18" w x 14.5" d x 20" h

LOPAR-38C2
LOPAR-38C0

Features 1¼" thick top.

b Parkdale Round Coffee Table with Shelf

35¾" dia. x 18¾" h
41¾" dia. x 18¾" h
47¾" dia. x 18¾" h

LOPAR-23A0A
LOPAR-23A1A 
LOPAR-23A2A

Features 1¼" thick top.

c Parkdale Round End Table with Shelf

16" dia. x 24¾" h
22" dia. x 24¾" h

LOPAR-26A3A
LOPAR-26A4A 

Features 1¼" thick top.

d Parkdale Sofa Table

48" w x 18" d x 28" h, 2 Drawers LOPAR-31C0A
60" w x 18" d x 28" h, 3 Drawers LOPAR-31C1A
Features 1¼" thick top.

e Parkdale Sofa Table with Shelf

48" w x 18" d x 28¾" h, 2 drawers
60" w x 18" d x 28¾" h, 3 drawers
Features 1¼" thick top.

LOPAR-31A0A
LOPAR-31A1A

f Parkdale Sofa/Dining Table

Features one 12" butterfly leaf.
54" w x 18" d x 30½" h
(30" d with leaf)
60" w x 18" d x 30½" h
(30" d with leaf)

LOPAR-19A0
LOPAR-19A08



a



b Lift Top Available



c



d



e



f



g



h



i



j

a Prairie Mission 2-Door Coffee Table
46" w x 23" d x 18" h TV2346DCT
Features open space behind doors.

b Prairie Mission Coffee Table
46" w x 23" d x 18" h TV2346CT
Lift top
46" w x 23" d x 18" h TV245LCT

c Prairie Mission 2-Drawer Coffee Table
46" w x 23" d x 18" h TVD2346CT

d Prairie Mission Sofa Table
48" w x 16" d x 26½" h TV1648ST
60" w x 16" d x 26½" h TV1660ST

e Prairie Mission 1-Drawer Console Table
36" w x 15" d x 30" h TV110CT

f Prairie Mission 2-Drawer Sofa Table
48" w x 16" d x 27" h TVD1648ST
60" w x 16" d x 27" h TVD1660ST

g Prairie Mission 1-Drawer End Table
20" w x 26" d x 22" h TVDPME

h Prairie Mission End Table
20" w x 26" d x 22" h TVPME

i Prairie Mission Door End Table
20" w x 26" d x 22" h TVOPME

j Prairie Mission 1-Drawer Chair Side Table
16" w x 26" d x 22" h TVPMCST



a

Lift Top Available



b



c



d



12" butterfly leaf



e

Lift Top Available



f



g



h



i

a Shaker 1-Drawer Coffee Table

44" w x 26" d x 18" h JFSC2644

Lift top - No drawer with lift top option.

44" w x 26" d x 18" h JFSC2644-LT

b Shaker 1-Drawer End Table

20" w x 26" d x 22" h JFSE2026

c Shaker 1-Drawer Sofa Table

48" w x 16" d x 29" h JFSS1648

d Shaker Sofa/Dining Table

54" w x 18" d x 30" h LOSKR-19A0

60" w x 18" d x 30" h LOSKR-19A08

Features a 12" stationary butterfly leaf, table becomes 54" x 30" with leaf in.

e Shaker Hill Coffee Table

48" w x 27" d x 17½" h MASH2748

Lift top

48" w x 27" d x 17½" h MASH2748-LT

f Shaker Hill 4-Drawer Square Coffee Table

42" w x 42" d x 18" h MASH4242

g Shaker Hill 1-Drawer End Table

22" w x 24" d x 24" h MASH2224

h Shaker Hill Chair Side Table

16" w x 24" d x 24" h MASHCST

i Shaker Hill Cabinet Chair Side Table

16" w x 22" d x 24" h MASKRCABCS

Features open space behind door.



a



b



c

Lift Top Available

Inset Knob

LIVE

OCCASIONAL TABLES



d



e



f

a Shaker Hill 1-Drawer Telephone Table
21" w x 16" d x 29½" h MASH1621PS

b Shaker Hill Sofa Table
54" w x 16" d x 29½" h MASH1654

c Shaker Hill Cabinet Collection

Coffee Table
42" w x 22" d x 17½" h MASKRCAB-C

Features open space behind doors.

Lift-top Coffee Table
42" w x 22" d x 17½" h MASKRCAB-LFT

Features open space behind doors.

End Table
20" w x 22" d x 24" h MASKRCAB-E

Features open space behind doors.

Sofa Table
48" w x 16" d x 29½" h MASKRCAB-S

Features one fixed shelf behind doors.

d Sheridan End Table with Shelf
16" w x 24" d x 24" h LOSHR-28A0A
24" w x 24" d x 24" h LOSHR-28A1A
Walnut Accents Standard

e Sheridan Coffee Table with Shelf
42" w x 22" d x 18" h LOSHR-25A0A
48" w x 24" d x 18" h LOSHR-25A1B
54" w x 30" d x 18" h LOSHR-25A2C
Walnut Accents Standard

f Sheridan Sofa Table with Shelf
56" w x 18¾" d x 32" h LOSHR-31A0A
Walnut Accents Standard



a

Lift Top Available



b

Lift Top Available



c



d



e



f



g



h



i



12" butterfly leaf

a Sophia 1-Drawer Coffee Table

48" w x 25" d x 19 1/4" h TVSOCT

Lift top (No Drawer)

48" w x 25" d x 19 1/4" h TVSOCT-LT

Lift top features a false drawer front.

b Sophia 1-Drawer Square Coffee Table

36" w x 34 1/4" d x 19 1/4" h TVSOCT

Lift top (No Drawer)

36" w x 34 1/4" d x 19 1/4" h TVSOCT-LT

Lift top features a false drawer front.

c Sophia 1-Drawer End Table

22" w x 26" d x 23 1/2" h TVSOET

d Sophia 1-Drawer Chair Side Table

16" w x 26" d x 23" h TVSOCST

e Sophia 1-Drawer Sofa Table

48" w x 16" d x 30 1/4" h TVSOST

f Valhalla Coffee Table

54" w x 30" d x 18" h LOVAH-02A0

g Valhalla End Table

22" w x 26" d x 22" h LOVAH-06A

h Valhalla Sofa Table

54" w x 18" d x 29" h LOVAH-13A0

i Valhalla Sofa/Dining Table

54" w x 18" d x 30" h LOVAH-20A0

60" w x 18" d x 30" h LOVAH-20A08

Features a 12" stationary butterfly leaf, table becomes 30" deep with leaf. (Ex. 54" w x 30" d or 60" w x 30" d)



a Lift Top Available



b



c



d



e



f



g



h

a Virginia Coffee Table

44" w x 26" d x 19" h NO413CT

Lift top

44" w x 26" d x 19" h NO413LTCT

b Virginia 1-Drawer End Table

20" w x 26" d x 24" h NO414ET

c Virginia 1-Drawer Sofa Table

44" w x 16½" d x 29" h NO415ST

d Wildwood Coffee Table with Drawers

42" w x 22" d x 17¼" h LOWIL-25C3A

54" w x 24" d x 17¼" h LOWIL-25C4A

e Wildwood Coffee Table with Shelf

42" w x 22" d x 17¼" h LOWIL-25A3A

54" w x 24" d x 17¼" h LOWIL-25A4A

f Wildwood End Table with Shelf

16" w x 20" d x 24¼" h LOWIL-28A2B

20" w x 24" d x 24¼" h LOWIL-28A3B

24" w x 20" d x 24¼" h LOWIL-28A4A

g Wildwood Cross Base End Table

20" w x 24" d x 24" h LOWIL-34C4A

h Wildwood Sofa Table with Shelf

48" w x 16" d x 29¼" h LOWIL-31A0A

60" w x 16" d x 29¼" h LOWIL-31A1A

72" w x 16" d x 29¼" h LOWIL-31A2A

CONSOLE CABINETS

LIVE



a



b



c



d



e



f



g



h

Features 2 secret drawers



i

a Aries Credenza, 60"

Black Base
60"w x 18"d x 36"h ESARI-31C-B

b Dovetail Console, 48"

48"w x 18"d x 32"h LEDOV-C44A
Features bottom drawer.

c Aspen Console Cabinet with Inlay

54"w x 16"d x 30 3/4"h LOASP-40A-1A
60"w x 16"d x 30 3/4"h LOASP-40A-2A
Features shelf behind doors.

d Grant Console Cabinet

54 3/8"w x 15 1/2"d x 30"h LOGRT-40A-1A
60 3/8"w x 15 1/2"d x 30"h LOGRT-40A-2A

e Justine Console Cabinet

54"w x 15"d x 30"h LOJUS-40A-1A
60"w x 15"d x 30"h LOJUS-40A-2A

f Loft Cabinet Sofa Table

48"w x 16"d x 30"h NOL01648S
Features open space behind doors.

g Loft Console Cabinet

54"w x 16"d x 30 3/4"h LOLFT-40A-1A
60"w x 16"d x 30 3/4"h LOLFT-40A-2A

h Louis Philippe Console Cabinet

54"w x 16"d x 30"h LOLPP-40A-1A
60"w x 16"d x 30"h LOLPP-40A-2A
Features 2 secret drawers.

i B&O Railroad® Trestle Bridge Console Cabinet

54"w x 15"d x 30 3/4"h LOTRB-40A-1A
60"w x 15"d x 30 3/4"h LOTRB-40A-2A

DISPLAY CABINETS

LIVE



a Large Console ✱
50" w x 13" d x 30" h NOLC
Features two adjustable glass shelves with plate grooves, 2-LED light system, mirror back and unfinished back.

b Deluxe 2-Door Curio ✱
52" w x 14" d x 72" h NO2WDC
Features four adjustable glass shelves with plate grooves, 2-LED light system and mirror back.

c 2-Door Curio ✱
40" w x 14" d x 72" h NO2DC
Features four adjustable glass shelves with plate grooves, 2-LED light system and mirror back.

d Small Sliding Door Curio ✱
32" w x 14" d x 72" h NOSSD
Features four adjustable glass shelves with plate groove, 2-LED light system and mirror back. Opens to left.

e Large Sliding Door Curio ✱
40" w x 14" d x 72" h NOLSD
Features four adjustable glass shelves with plate groove, 2-LED light system and mirror back. Opens to left.

f Corner Curio ✱
36" w x 26" d x 72" h NOCD
25" from corner.
Features four adjustable glass shelves with plate groove, 2-LED light system and mirror back.

g Justine 2-Door Curio ✱
36" w x 14" d x 73" h SCJ2DC
Features four adjustable glass shelves with plate grooves, 2-LED light system and mirror back.

h Justine Display
24" w x 16" d x 71½" h KAJDS
Shelf area: 23¾" x 16" d
Features four adjustable shelves.

OTHER

LIVE



a



b



c



d



e



f



g

ALL ITEMS ON THIS PAGE FEATURE A LIFT SEAT WITH STORAGE UNDERNEATH.

a B&O Railroad® Trestle Bridge Hall Bench
53½" w x 20" d x 72¾" h LSTRB-B02A

b Aspen Hall Bench with Inlay
48" w x 19½" d x 72¼" h KAHB448
Seat: 41¼" w x 18½" d x 18½" h

c Mission Hall Bench
Large KAHB48F
48½" w x 18½" d x 72" h
Small KAHB36F
36½" w x 18½" d x 72" h

d Prairie Mission Hall Bench
48" w x 19" d x 70" h TV270HSM

e Hall Seat with Oval Beveled Mirror
24¼" w x 17¾" d x 72¼" h JCBH0B-W

f Mission Hall Seat with Beveled Mirror
26" w x 15½" d x 80" h LFMHSB

g Aspen Hall Seat with Mirror and Inlay
23" w x 16" d x 72¾" h KAAHS
Seat: 16" w x 14½" d x 19" h



a



b



c



d

SELECT THE HOOK THAT SUITS YOUR STYLE



Antique Porcelain Hook
(SAOH-AP)



Brass Porcelain Hook
(SAOH-BP)



Black Hook
(SAOH-BK)



Brass Hook
(SAOH-BR)



Brushed Nickel Hook
(SAOH-BN)

Not available on d.



e

a Hall Tree with Octagon Base
18½" w x 18½" d Base x 69" h LFHT0B
Not available in quartersawn white oak.

b Four-Leg Hall Tree
24¾" w x 24¾" d Base x 67¾" h LFHT4L
Not available in quartersawn white oak.

c Hall Tree
18" w x 18" d x 67" h CW67HT

d Shaker Hall Tree
26" w x 26" d x 74" h WTM3601

e Mirror Frame with Hooks
39" w x 5" d x 15" h FA1437BV
Features beveled mirrors and four hooks.

LIVE

OTHER



a



b



c



d

a Loft Minibar

36" w x 25" d x 43" h

LSLFT-C02C

Opens to 72" w, 63 1/4" h

Features 3 adjustable, reversible shelves for wine bottles on one side or flip them over for storing other items on the flat surfaces, an extra-large drawer on the bottom, wine glass hangers at the top of the door opening, a hinged top that doubles the serving capacity of the top surface, and a hidden storage compartment with a quiet electric lift that opens by remote control or by the switch installed in the side of the cabinet. Big stuff in a small space.

b Prairie Mission Quilt Stand

29 1/2" w x 11" d x 34" h

TVPMQS

c Sophia Coat Shelf

50" w x 11" d x 17" h

KASCS

Storage spaces are 15 1/4" w x 10" d x 8" h.

d Sophia Storage Bench

50" w x 18" d x 19" h

KASSB

Storage spaces are 15 1/4" w x 17 1/4" d x 13" h.



a



b



Each sold separately.



c



d

a Leaning Floor Mirror

38" w x 1¼" d x 72½" h MEAFM

Features a beveled mirror.

b Shaker Hill Plant Stand

12" w x 12" d x 20" h MASKR-20P

12" w x 12" d x 26" h MASKR-26P

12" w x 12" d x 32" h MASKR-32P

c Prairie Mission Plant Stand

12" w x 12" d x 28" h TVPMPS28

12" w x 12" d x 36" h TVPMPS36

d Round Plant Stand

14" dia. x 20" h TVRPS20

14" dia. x 26" h TVRPS26

14" dia. x 32" h TVRPS32

DESKS

WORK



E. Chupp
SHOWN IN CHERRY, MOCHA NUT



IF YOU HAVE TO WORK IN AN OFFICE, YOU MIGHT AS WELL DO IT IN STYLE. FROM WRITING DESKS TO ROLLTOPS, WE OFFER AN EXTENSIVE COLLECTION OF DESKS, CABINETS AND INDIVIDUAL WORKSTATION COMPONENTS DESIGNED TO SUPPORT A BUNCH OF DEVICES THE AMISH WOULDN'T USUALLY USE.

CONVERTIBLE DRAWER

Most of our desks come standard with the center desk drawer as our convertible drawer (shown left). The convertible drawer allows for the drawer to be used as either a keyboard pullout drawer or as a pencil drawer. This feature is listed on each desk where standard.

ONCE AGAIN PEOPLE ARE FOLLOWING IN OUR FOOTSTEPS.

For hundreds of years the Amish have gone wireless — what we are wondering is why it has taken so long to catch on. However, now that it has, we are changing the way we make our desks. All desks now come standard without a hole or a grommet in the top surface.

If you would like a hole and grommet in the top surface of your desk, you will need to order the option (SAOGM) and specify the placement of the hole. Note: If it is not specified the hole will be made in the back right side of the knee area.



a

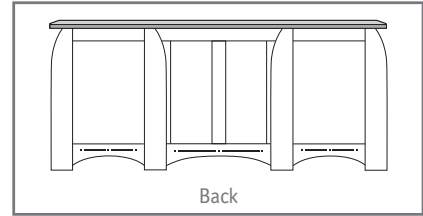

Back



b



Back



c

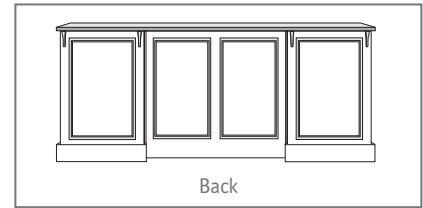

Back



d



Back

a Aspen Executive Desk with Inlay, Large
72" w x 34" d x 31" h ECA800
Knee Area: 28" w x 24 3/4" h
Features finished back, convertible drawer, two pullouts, and two file drawers. Delivers in 5 pieces.

Aspen Executive Desk with Inlay, Medium
64" w x 34" d x 30 1/2" h WDASP-02J5
Knee Area: 20" w x 24 3/4" h
Features finished back, convertible drawer, two pullouts, and two file drawers. Delivers in 5 pieces.

b B&O Railroad® Trestle Bridge Executive Desk
78" w x 32" d x 32" h WDRB-02A5
Knee Area: 32 1/2" w x 24 1/2" h
Features finished back, convertible drawer, and two file drawers. Delivers in 5 pieces.

c Classic Executive Desk, Large
72" w x 36" d x 31" h IW72FTR
Knee Area: 34" w x 26" h
Features finished back, convertible drawer, two pullouts, and two file drawers. Delivers in 5 pieces.

Classic Executive Desk, Medium
62" w x 31" d x 31" h WDCLA-02J5
Knee Area: 24" w x 26" h
Features finished back, convertible drawer, two pullouts, and two file drawers. Delivers in 5 pieces.

d Colburn Executive Desk, Large
72" w x 31" d x 31" h WDCBN-02A5
Knee Area: 32" w x 24 3/4" h
Features finished back, convertible drawer, two pullouts, and two file drawers. Delivers in 5 pieces.

Colburn Executive Desk, Medium
62" w x 31" d x 31" h WDCBN-02J5
Knee Area: 22" w x 24 3/4" h
Features finished back, convertible drawer, two pullouts, and two file drawers. Delivers in 5 pieces.



a



Back



b



Back



c

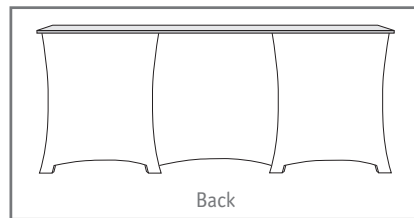

Back



d

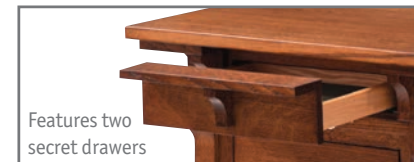

Features two secret drawers



Back

a Garrett Executive Desk, Large
 72" w x 26" d x 30" h WDGAR-02A1
 Knee Area: 30" w x 24¾" h
 Features finished back, convertible drawer, two pullouts, and two file drawers.
 Delivers in 1 piece.
Garrett Executive Desk, Medium
 62" w x 26" d x 30" h WDGAR-02B1
 Knee Area: 20" w x 24¾" h
 Features finished back, convertible drawer, two pullouts, and two file drawers.
 Delivers in 1 piece.

b Justine Executive Desk, Large
 72" w x 32" d x 30" h DLJUEXOD
 Knee Area: 31" w x 24½" h
 Features finished back, convertible drawer, two pullouts, and two file drawers.
 Delivers in 5 pieces.
Justine Executive Desk, Medium
 62" w x 32" d x 30" h WDJUS-02J5
 Knee Area: 21" w x 24½" h
 Features finished back, convertible drawer, two pullouts, and two file drawers.
 Delivers in 5 pieces.

c Loft Executive Desk
 72" w x 32" d x 30" h NOL03272D
 Knee Area: 28½" w x 24" h
 Features finished back, convertible drawer, two pullouts, and two file drawers.
 Delivers in 5 pieces.

d MäRyan Executive Desk
 74" w x 36" d x 30¾" h NWMEXD
 Knee Area: 24" w x 24" h
 Features finished back, pencil drawer, two secret drawers, two pullouts, and two file drawers.
 Convertible drawer not available.
 Delivers in 5 pieces.



a

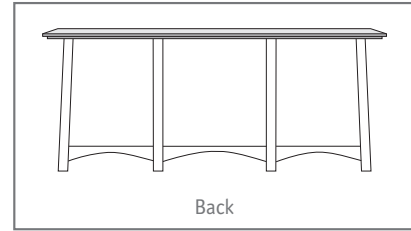

Back



b

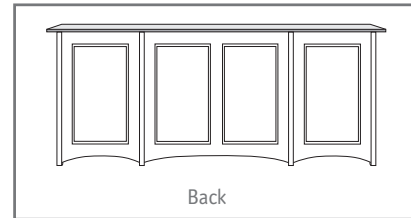

Back



c

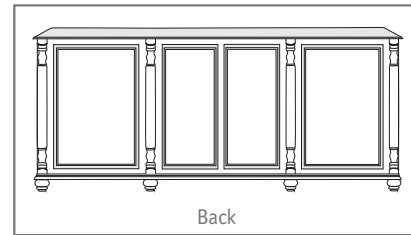

Back



d



Back

a McCoy Executive Desk
 69" w x 36" d x 31" h MAMC3669PD
 Knee Area: 24" w x 23½" h
 Features finished back, convertible drawer, three file drawers and two pullouts.
 Delivers in 1 piece.

b Prairie Mission Executive Desk, Large
 74" w x 37" d x 30" h GW2045ED
 Knee Area: 37½" w x 24" h
 Features a finished flat-panel back, convertible drawer, and two file drawers.
 Delivers in 5 pieces.

Prairie Mission Executive Desk, Medium
 62" w x 32" d x 30" h GW2035D
 Knee Area: 25½" w x 24" h
 Features a finished flat-panel back, convertible drawer, and two file drawers.
 Delivers in 5 pieces.

c Savannah Executive Desk
 72" w x 32" d x 30" h NOSV3272D
 Knee Area: 26" w x 24" h
 Features raised panel back, convertible drawer, two pullouts, and two file drawers.
 Delivers in 5 pieces.

d Shenandoah Executive Desk, Large
 72" w x 26" d x 30" h WDSHS-02A5
 Knee Area: 30" w x 24¾" h
 Features finished back, convertible drawer, two pullouts, and two file drawers.
 Delivers in 1 piece.

Shenandoah Executive Desk, Medium
 62" w x 26" d x 30" h WDSHS-02J5
 Knee Area: 20" w x 24¾" h
 Features finished back, convertible drawer, two pullouts, and two file drawers.
 Delivers in 1 piece.



a



b



Raises to 50 $\frac{3}{4}$ " high.

c Grey base option available. Controller may vary.



Raises to 50 $\frac{3}{4}$ " high.

d Grey base option available. Controller may vary.



Raises to 50 $\frac{3}{4}$ " high.

e Grey base option available. Controller may vary.

a Garrett Credenza, Large

72" w x 22" d x 30" h

WDGAR-05A1

Knee Area: 30" w x 24 $\frac{1}{2}$ " h

Garrett Credenza, Medium

62" w x 22" d x 30" h

WDGAR-05B1

Knee Area: 20" w x 24 $\frac{1}{2}$ " h

b Shenandoah Credenza, Large

72" w x 22" d x 30" h

WDSHS-05C

Knee Area: 30" w x 24 $\frac{1}{2}$ " h

Shenandoah Credenza, Medium

62" w x 22" d x 30" h

WDSHS-05B

Knee Area: 20" w x 24 $\frac{1}{2}$ " h

c Blocher Lift Desk

67 $\frac{1}{4}$ " w x 27" d

WDBLO-24G

Black Base Standard. Bottom drawer is a file drawer.

Raises to 50 $\frac{3}{4}$ " high.

d Blocher II Lift Desk

67 $\frac{1}{4}$ " w x 27" d

WDBL2-24G

Black Base Standard.

Raises to 50 $\frac{3}{4}$ " high.

e Blocher III Lift Desk

67 $\frac{1}{4}$ " w x 27" d

WDBL3-24G

Black Base Standard. Bottom drawer is a file drawer.

Raises to 50 $\frac{3}{4}$ " high.



a



b



c



d

a Aspen Credenza with Inlay, Large

72" w x 23" d x 30½" h ECA790
Knee Area: 28" w x 24" h

Aspen Credenza with Inlay, Medium

64" w x 23" d x 30" h WDASP-05B
Knee Area: 20" w x 24" h

Features unfinished back, convertible drawer, two pullouts, and two file drawers.

Aspen Hutch Top for Desk or Credenza with Inlay, Large

72" w x 17" d x 50" h ECA795
Side area under doors: 14" h; Center: 17" h

Aspen Hutch Top for Credenza with Inlay, Medium

64" w x 17" d x 50" h WDASP-07A6

b Colburn File Credenza, Large

72" w x 22" d x 30" h WDCBN-05C
Knee Area: 34" w x 24" h

Features unfinished back, convertible drawer, and two file drawers.

Colburn File Credenza, Medium

62" w x 22" d x 30" h WDCBN-05B
Knee Area: 24" w x 24" h

Features unfinished back, convertible drawer, and two file drawers.

Colburn Hutch Top for Desk or Credenza, Large

73" w x 15½" d x 49" h WDCBN-07A5
Side area under doors: 14" h; Center: 17" h

Colburn Hutch Top for Desk or Credenza, Medium

63" w x 15½" d x 49" h WDCBN-07A6
Side area under doors: 14" h; Center: 17" h

c Justine Credenza, Large

72" w x 22" d x 30" h DLJUCR
Knee Area: 31" w x 24¾" h

Features unfinished back, convertible drawer, two pullouts, and two file drawers.

Justine Credenza, Medium

62" w x 22" d x 30" h WDJUS-05B
Knee Area: 21" w x 24¾" h

Features unfinished back, convertible drawer, two pullouts, and two file drawers.

Justine Hutch Top for Desk or Credenza, Large

70" w x 14" d x 49¾" h DLJUHT
Side area under doors: 14" h; Center: 17" h

Justine Hutch Top for Credenza, Medium

60" w x 14" d x 49¾" h WDJUS-07A6
Features one adjustable shelf behind each door.

d Loft Credenza

72" w x 22" d x 30" h NOL02272C
Knee Area: 28" w x 20½" d x 24" h

Features unfinished back, convertible drawer, and two file drawers.

Loft Hutch Top for Desk or Credenza

72" w x 15" d x 48" h NOL01472H
Open Area: 26" w x 22" h

Features two adjustable shelves behind doors.



a



b



c



d

a MäRyan Credenza

74" w x 24 3/4" d x 30" h NWMCD

Knee Area: 26" w x 24" h
Features unfinished back, pencil drawer, two secret drawers, two pullouts, and two file drawers.

MäRyan Hutch Top for Desk or Credenza

74" w x 18" d x 50" h NWMHT

Side area under doors: 14" h; Center: 17" h
Features adjustable shelves behind glass doors.

b Prairie Mission File Drawer Credenza, Large

74" w x 22 1/4" d x 30" h GW2000FC

Features unfinished back, one adjustable shelf and four file drawers.

Prairie Mission Hutch Top with Mullions, Large

76" w x 16" d x 49" h GW2015HT*

Open Area: 35 1/2" w x 26 1/2" h

c Prairie Mission Computer Credenza, Large

74" w x 22 1/4" d x 30" h GW2005CC

Knee Area: 37 1/2" w x 21" d x 24 1/4" h
Tower Area: 13 1/2" w x 20" d x 23 1/2" h

Features unfinished back, convertible drawer, and two file drawers.

Prairie Mission Computer Credenza, Medium

62" w x 22 1/2" d x 30" h WDPMS-05B

Knee Area: 25" w x 21" d x 24 1/4" h
Tower Area: 13 1/2" w x 20" d x 23 1/2" h

Features unfinished back, convertible drawer, and two file drawers.

Prairie Mission Hutch Top with Drawers, Large

76" w x 16" d x 49" h GW2025HT

Open Area: 56" w x 22" h

Features work light, CD drawers, and one adjustable shelf behind doors.

Prairie Mission Hutch Top with Drawers, Medium

64" w x 16" d x 49" h WDPMS-07C6

Open Area: 44" w x 22" h

Features task light, and six CD drawers.

d Savannah Credenza

72" w x 22" d x 30" h NOSV2272C

Knee Area: 23 3/4" w x 20" d x 24" h

Features unfinished back, convertible drawer, and two file drawers.

Savannah Hutch Top for Desk or Credenza

75" w x 17 1/2" d x 50" h NOSV1472H

Side Area: 14" h; Center: 27" w x 17" d

Features antique glass in doors standard.

*Not available with Beveled Glass.



a



Back



b



Back



c



Back

a Aspen L-Shape Desk with Inlay

Left Return ECA805-L
Right Return ECA805-R

Footprint: 76" w x 82" d
Desk: 76" w x 34" d x 31" h
Return: 48" w x 26" d x 30" h

Features a convertible drawer and two file drawers.
Delivers in 2 pieces.

Aspen Hutch Top for Desk or Credenza with Inlay, Large (not shown)

72" w x 17" d x 50" h ECA795
Side area under doors: 14" h; Center: 17" h
See credenza section.

b Colburn L-Shape Desk

Plain back, Left Return WDCBN-09H2
Plain back, Right Return WDCBN-15H2

Raised-panel back, Left Return WDCBN-09I2
Raised-panel back, Right Return WDCBN-15I2

Knee Area: 23 3/4" h
Footprint: 74 3/4" w x 77 3/4" d
Desk: 74 3/4" w x 29 3/4" d x 30" h
Return: 48" w x 23 3/4" d x 30" h

Features a convertible drawer and two file drawers.
Delivers in 2 pieces.

Colburn Hutch Top for Desk or Credenza, Large (not shown)

73" w x 15 1/2" d x 49" h WDCBN-07A5
Side area under doors: 14" h; Center: 17" h

c Justine L-Shape Desk

Left Return WDJUS-09I2
Right Return WDJUS-15I2

Knee Area: 23 3/4" h
Footprint: 75" w x 80" d
Desk: 75" w x 30" d x 30" h
Return: 48" w x 24" d x 30" h

Features a convertible drawer and two file drawers.
Delivers in 2 pieces.

Justine Hutch Top for Desk or Credenza, Large (not shown)

70" w x 14" d x 49 3/4" h DLJUHT
Side area under doors: 14" h; Center: 17" h

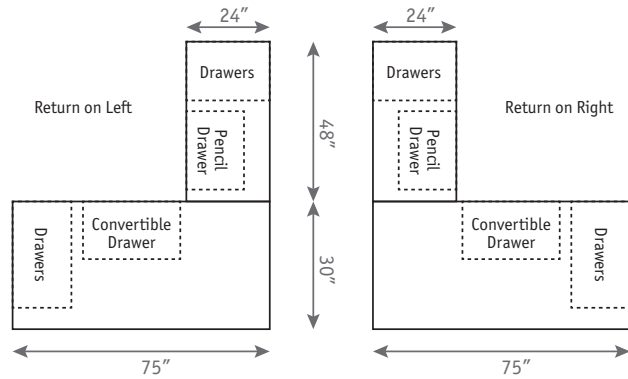

a



b

a Classic L-Shape Desk

- Plain back , Left Return GWCP7578L-L
- Plain back , Right Return GWCP7578L-R
- Raised-panel back, Left Return GWCR7578L-L
- Raised-panel back , Right Return GWCR7578L-R

Knee Area: 23¾”h
 Desk Area: 75”w x 30”d x 30¼”h
 Return: 48”w x 24”d

Features a convertible drawer on the desk side.
 Delivers in 2 pieces.

Classic Hutch Top

75½”w x 16”d x 48½”h GW2020HT

Features a task light in the open area and six CD drawers.
 Can also be purchased with Executive Desks.
 Features one adjustable shelf behind doors.

b Prairie Mission L-Shape Desk

- Plain back, Left Return GWPP7578L-L
- Plain back , Right Return GWPP7578L-R
- Flat-panel back, Left Return GWPM7578L-L
- Flat-panel back, Right Return GWPM7578L-R

Knee Area: 23¾”h
 Desk Area: 75”w x 30”d x 30¼”h
 Return: 48”w x 24”d

Features a convertible drawer on the desk side.
 Delivers in 2 pieces.

Prairie Mission Hutch Top with Drawers, Large

76”w x 16”d x 49”h GW2025HT

Features a task light in the open area and six CD drawers.
 Can also be purchased with Executive Desks.
 Features one adjustable shelf behind doors.

Shown with raised panel ends option.



a



b

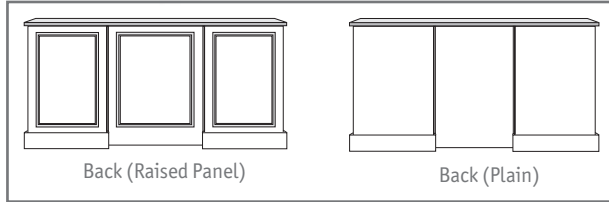

Back (Raised Panel)

Back (Plain)

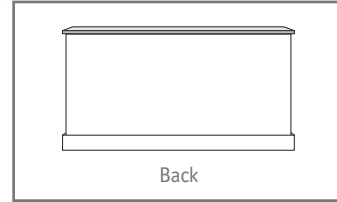

Back



c



d



e



Back

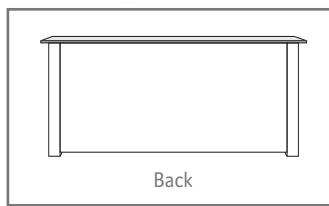

Back

a Classic Desk, Medium

62" w x 32" d x 31" h IW60FTDP
Knee Area: 22½" w x 24¾" h

Features finished back, convertible drawer, two pullouts, and two file drawers.

Delivers in 5 pieces.

b Classic Desk, Small

50" w x 32" d x 31" h IW48FTDP
Knee Area: 27" w x 26" h

Features finished back, convertible drawer, one pullout, and one file drawer.

Delivers in 1 piece.

c Justine Desk, Small

48" w x 22" d x 30¼" h DLJUSD
Knee Area: 25" w x 24¼" h

Features finished back, convertible drawer, and one file drawer.

Delivers in 1 piece.

d Prairie Mission Desk, Small

50" w x 31" d x 30" h GW2030D
Knee Area: 29" w x 24" h

Features a finished back, convertible drawer, one pullout and one file drawer.

Delivers in 1 piece.

e Shenandoah Desk, Small

46" w x 20" d x 30¼" h WDSHS-03C
Knee Area: 24" w x 24½" h

Features finished back and a convertible drawer.



Shown in Olde World Finish and 2-Tone option.



a Aspen Writing Desk with Inlay

54" w x 30" d x 30" h ECACD, Small
 60" w x 30" d x 30" h WDASP-04B1, Medium
 Knee Area: 47" w x 23½" h
 Features a convertible drawer.

b Justine Writing Desk

54" w x 30" d x 30" h KAJD
 Knee Area: 48" w x 24" h
 Features 2 drawers.

c MäKayla Writing Desk

64" w x 30" d x 30¾" h TVM3064D
 Knee Area: 50" w x 24" h
 Features 3-drawers.
 Convertible drawer not available.

d Metropolis Writing Desk

54" w x 30" d x 30¾" h KAMD
 Knee Area: 48" w x 23½" h
 Features 2 drawers.

e Prairie Mission Writing Desk, Large

64" w x 30" d x 30" h TVPMD3064
 Knee Area: 53¾" w x 24" h
 Features a convertible drawer and two side drawers.



a



b



c



d



e



f

a Prairie Mission Writing Desk, Medium

54" w x 26" d x 30" h TVPMD2654
Knee Area: 43 3/4" w x 24" h

Features a convertible drawer.

b Prairie Mission Library Desk

48" w x 20" d x 30" h TV120WT
Knee Area: 24" w x 25 1/2" h
Shelf Area: 12" w x 9" h

Features a fixed shelf and convertible drawer.

c Prairie Mission Writing Desk, Small

34" w x 20" d x 30" h TV125SWT
Knee Area: 24" w x 25 1/2" h

Features a convertible drawer.

d B&O Railroad® Terminal Desk, Executive

46" w x 24" d x 55 3/4" h WDTRM-16A15
Fold down door is 43" w x 18 1/2" h
Back is not finished.

Features six smaller drawers, two file drawers, a shallow secret area under the top and a black leather desk pad.

e B&O Railroad® Terminal Desk, Secretary

46" w x 24" d x 55 3/4" h WDTRM-16B15
Fold down door is 43" w x 18 1/2" h
Back is not finished.

Features four drawers, a shallow secret area under the top and a black leather desk pad.

f Secretary's Desk

25" w x 16" d x 42 1/2" h NOSD24, Small
31" w x 16" d x 42 1/2" h NOSD30, Medium

Available with turned legs, plain round legs or square tapered legs. Please specify.



a



b



c

a Classic Rolltop Desk

62" w x 31" d x 48" h WSPM3060RT
 Knee Area: 24" w x 24" h
 57" w x 31" d x 48" h WSPM3054RT
 Knee Area: 18" w x 24" h
 Back comes unfinished.
 Delivers in 5 pieces.

Hutch Top for Rolltop Desk

57½" w x 15¾" d x 34" h WS54HTB
 63½" w x 15¾" d x 34" h WS60HTB

b Prairie Mission Rolltop Desk

56" w x 31" d x 48" h WSPM3054RT
 Knee Area: 19½" w x 24" h
 62" w x 31" d x 48" h WSPM3060RT
 Knee Area: 25½" w x 24" h
 Back comes unfinished.
 Delivers in 5 pieces.

c Aspen Laptop Secretary

35" w x 21" d x 81" h WDASP-23G1
 Center area: 16¼" w x 17½" d x 14" h
 Padded work surface: 23" w x 11½" d



a



b



c



d



e



f

a B&O Railroad® Trestle Bridge Laptop Secretary

39½" w x 19½" d x 81¼" h WDRB-23G1

Center area: 18¼" w x 17½" d x 14" h

Padded work surface: 28¾" w x 14½" d

b Grant Laptop Secretary

34" w x 18½" d x 85" h WDGR-23G1

Center area: 16½" w x 17¼" d x 14" h

Padded work surface: 26¼" w x 12" d

c Justine Laptop Secretary

34" w x 18½" d x 81¼" h WDJUS-23G1

Center area: 21½" w x 17¼" d x 14" h

Padded work surface: 25¼" w x 13½" d

d Loft Laptop Secretary

34" w x 18½" d x 81½" h WDLFT-23G1

Center area: 16¼" w x 17" d x 14½" h

Padded work surface: 19¾" w x 12" d

e Prairie Mission Laptop Secretary

34" w x 19" d x 81½" h WDPMS-23G1

Center area: 19½" w x 18" d x 14¼" h

Padded work surface: 27¼" w x 12" d

f Shenandoah Laptop Secretary

34" w x 18" d x 81¼" h WDSHS-23G1

Center area: 17" w x 16¾" d x 14½" h

Padded work surface: 26½" w x 14¼" d



a



b



c



d



e



f

a Aspen Laptop Cabinet with Inlay
35" w x 18" d x 58" h FDASPLC

Top open area: 26" w x 17" d x 8³/₄" h
Center area: 16¹/₄" w x 17¹/₂" d x 14" h
Padded work surface: 23" w x 11¹/₂" d
Bottom door area: 26" w x 17" d x 19¹/₂" h
Back comes unfinished.

Features one adjustable shelf behind doors.

b Aspen Laptop Cabinet with File Drawer and Inlay
35" w x 20" d x 58" h WDASP-08G0

Top open area: 26" w x 17" d x 8³/₄" h
Center area: 16¹/₄" w x 17¹/₂" d x 14" h
Padded work surface: 23" w x 11¹/₂" d
Back comes unfinished.

c B&O Railroad® Trestle Bridge Laptop Cabinet with File Drawer
39³/₄" w x 19³/₄" d x 61" h WDTRB-08G1

Top open area: 28³/₄" w x 16¹/₂" d x 11" h
Center area: 18¹/₄" w x 17¹/₂" d x 14" h
Padded work surface: 28³/₄" w x 14¹/₂" d
Back comes unfinished.

d Grant Laptop Cabinet
34" w x 16³/₄" d x 62¹/₂" h FDGRLC

Top open area: 29¹/₄" w x 14¹/₄" d x 10" h
Center area: 18¹/₂" w x 14³/₄" d x 14¹/₂" h
Padded work surface: 26¹/₄" w x 12" d
Bottom door area: 29¹/₄" w x 13³/₄" d x 21" h
Back comes unfinished.

Features one adjustable shelf behind doors.

e Grant Laptop Cabinet with File Drawer
34" w x 18¹/₂" d x 62¹/₂" h WDGRA-08G0

Top open area: 29¹/₄" w x 17¹/₄" d x 10" h
Center area: 18¹/₂" w x 17¹/₄" d x 14¹/₂" h
Padded work surface: 26¹/₄" w x 12" d
Back comes unfinished.

f Justine Laptop Cabinet
34¹/₄" w x 14³/₄" d x 58¹/₂" h FDJSLC

Top open area: 28³/₄" w x 15³/₄" d x 11" h
Center area: 21¹/₂" w x 15³/₄" d x 14" h
Padded work surface: 25¹/₄" w x 13¹/₂" d
Bottom door area: 28³/₄" w x 14³/₄" d x 21" h
Back comes unfinished.

Features one adjustable shelf behind doors.



a



b



c



d



e



f

a Justine Laptop Cabinet with File Drawer
 34 $\frac{3}{4}$ "w x 18 $\frac{1}{2}$ "d x 58 $\frac{1}{2}$ "h WDJUS-08G0
 Top open area: 28 $\frac{1}{4}$ "w x 16 $\frac{1}{2}$ "d x 11"h
 Center area: 21 $\frac{1}{2}$ "w x 17 $\frac{3}{4}$ "d x 14"h
 Padded work surface: 25 $\frac{3}{4}$ "w x 13 $\frac{1}{2}$ "d
 Back comes unfinished.

b Loft Laptop Cabinet
 34 $\frac{3}{4}$ "w x 16 $\frac{3}{4}$ "d x 58 $\frac{1}{2}$ "h FDL0LC
 Top open area: 26"w x 15 $\frac{1}{2}$ "d x 11 $\frac{3}{4}$ "h
 Center area: 16 $\frac{3}{4}$ "w x 17"d x 14 $\frac{1}{2}$ "h
 Padded work surface: 19 $\frac{3}{4}$ "w x 12"d
 Bottom door area: 26"w x 15 $\frac{1}{2}$ "d x 22"h
 Back comes unfinished.
 Features one adjustable shelf behind doors.

c Loft Laptop Cabinet with File Drawer
 34"w x 18 $\frac{1}{2}$ "d x 58"h WDLFT-08G0
 Top open area: 26"w x 15 $\frac{1}{2}$ "d x 11 $\frac{3}{4}$ "h
 Center area: 16 $\frac{3}{4}$ "w x 17"d x 14 $\frac{1}{2}$ "h
 Padded work surface: 19 $\frac{3}{4}$ "w x 12"d
 Back comes unfinished.

d Prairie Mission Laptop Cabinet
 34"w x 16 $\frac{3}{4}$ "d x 58"h FDPMLC
 Top open area: 30"w x 15"d x 14"h
 Center area: 19 $\frac{1}{2}$ "w x 15"d x 14"h
 Padded work surface: 27 $\frac{1}{4}$ "w x 12"d
 Bottom door area: 30"w x 15"d x 21"h
 Back comes unfinished.
 Features one adjustable shelf behind doors.

e Prairie Mission Laptop Cabinet with File Drawer
 34"w x 19"d x 58"h WDPMS-08G0
 Top open area: 30"w x 15"d x 14"h
 Center area: 19 $\frac{1}{2}$ "w x 15"d x 14"h
 Padded work surface: 27 $\frac{1}{4}$ "w x 12"d
 Back comes unfinished.

f Shenandoah Laptop Cabinet with File Drawer
 34"w x 18 $\frac{3}{4}$ "d x 58 $\frac{1}{2}$ "h WDSHS-08G1
 Top open area: 27"w x 16 $\frac{3}{4}$ "d x 11 $\frac{1}{4}$ "h
 Center area: 17"w x 16 $\frac{3}{4}$ "d x 14 $\frac{1}{2}$ "h
 Padded work surface: 26 $\frac{1}{2}$ "w x 14 $\frac{1}{4}$ "d
 Back comes unfinished.

WRITING DESKS

STYLE YOUR OWN



42" X 24" WRITING DESK SHOWN WITH LOFT LEG, 1" RADIUS CORNER, MEDIUM ROUNDOVER EDGE, IN SOFT MAPLE, HAZELNUT



CREATE YOUR OWN WRITING DESK ONLINE
USING OUR EXCLUSIVE WEB APP AT
SIMPLYAMISH.COM

STEP 1 | SELECT SIZE

Comes standard with a 2 1/4" deep convertible drawer.



- 42" w x 24" d, 24" w Drawer Box WDBWD-17G2
- 48" w x 24" d, 24" w Drawer Box WDBWD-18G2
- 54" w x 24" d, 30" w Drawer Box WDBWD-19G2
- 60" w x 30" d, 30" w Drawer Box WDBWD-20G2
- 72" w x 30" d, 30" w Drawer Box WDBWD-21G2

STEP 2 | SELECT TOP SHAPE

- Square CornerSYO-SQ
- 1" Radius CornerSYO-R1
- 3" Radius CornerSYO-R3



WK-A-01 Wood Knob—Standard

Square Corner 1" Radius Corner 3" Radius Corner

STEP 3 | SELECT EDGE



Large Roundover SATE-10



Underside Bevel SATE-20

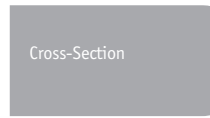

Small Roundover SATE-40



Large Bevel SATE-60

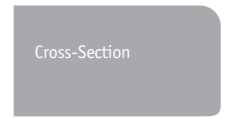

Medium Roundover SATE-80

STEP 4 | SELECT LEG



a b c d e f



g h i j k l



m n o p q

a Avalon (2½" Square Top)

- table height SAL-AV30
- counter height SAL-AV36
- bar height SAL-AV42

b Chatham (5" Square Top)

- table height SAL-CH30
- counter height SAL-CH36
- bar height SAL-CH42

c Loft (3½" Square Top)

- table height SAL-CR30
- counter height SAL-CR36
- bar height SAL-CR42

d Chesterville (3½" Square Top)

- table height SAL-CV30
- counter height SAL-CV36
- bar height SAL-CV42

e Fenton (3" Square Top)

- table height SAL-FE30
- counter height SAL-FE36
- bar height SAL-FE42

f Farm-Turned (3½" Square Top)

- table height SAL-FT30
- counter height SAL-FT36
- bar height SAL-FT42

g Irvington (3½" Square Top)

- table height SAL-IR30
- counter height SAL-IR36
- bar height SAL-IR42

h Justine (2½" Square Top)

- table height SAL-JS30
- counter height SAL-JS36
- bar height SAL-JS42

i Plain Round (3½" Square Top)

- table height SAL-PR30
- counter height SAL-PR36
- bar height SAL-PR42

j Reeded (3½" Square Top)

- table height SAL-RE30

k Loft II (2½" Square Top)

- table height SAL-SC30
- counter height SAL-SC36
- bar height SAL-SC42

l Small Square (2½" Square Top)

- table height SAL-SE30
- counter height SAL-SE36
- bar height SAL-SE42

m Medium Square (3½" Square Top)

- table height SAL-SM30
- counter height SAL-SM36
- bar height SAL-SM42

n Large Square (5" Square Top)

- table height SAL-SQ30
- counter height SAL-SQ36
- bar height SAL-SQ42

o Small Square-Tapered (2½" Square Top)

- table height SAL-SS30
- counter height SAL-SS36
- bar height SAL-SS42

p Square-Tapered (3½" Square Top)

- table height SAL-ST30
- counter height SAL-ST36
- bar height SAL-ST42

q Savannah (5" Square Top)

- table height SAL-SV30
- counter height SAL-SV36
- bar height SAL-SV42

OPTION

Edge Apron SYO-APRON

This option moves the apron out closer to the edge of the table and leaves a ¾" overhang. It is available only on square corner table shape because the leg will be very near to the edge of the table.

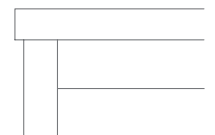

MODULAR OFFICE

STYLE YOUR OWN

Shown with non-standard hardware.

- 92-C-05 knobs on doors
- 92-D-06 pulls on drawer

E. Chipp

SHOWN IN CHERRY, MOCHA NUT



Regardless if it's destined for your home or office, you'll almost be thrilled to be working.

Features:

- Our modular office pieces can be ordered in about any dimension you need.
- The $\frac{5}{8}$ " thick drawers are dovetailed both front and back, sporting one piece drawer faces up to 8" tall.
- Blum Smart Slides are utilized for smooth, quiet drawer movement and soft closing.
- Concealed soft close hinges are standard.
- Wood shelves are standard unless you order with LED Light System or LED Task lights. Optional LED lighting comes standard with glass shelves.
- A convertible drawer in the desk — can be used as a pencil drawer or keyboard tray.
- Left or right return.
- Extra-heavy duty file drawers.
- Adjustable shelving.
- Adjustable levelers on base units.
- Includes pre-drilled holes and hardware for attaching units together.

Variety is the spice of life!

With five different styles of glass to choose from, your selection can dramatically impact the look and feel of your furniture.



Plain



Beveled



Frosted



Water



Antique

ORDERING GUIDE

STEP 1 | CHOOSE STYLE

Select the style that you desire.

All units are available in the eight styles shown on the next page. It is important to take note of the dimension changes that may apply for that style.

STEP 3 | CHOOSE TOP

Select the top units desired.

Select the door style and if applicable select the glass options.

STEP 2 | CHOOSE BASE UNIT

Select the base units desired.

If our standard sizes don't work for your space, no problem - just let us know your needs with a custom quote. Look for the to select glass options.

STEP 4 | SKETCH LAYOUT

Sketch the layout - Required

Indicate which end units are to be finished. Label the location of each cabinet to ensure proper alignment. (See diagram below for layout)

PLEASE NOTE

Our price list will show all eight styles of each unit together by page number and letter.

So for instance, to order an Aspen, Base Unit, 2-Lateral File Drawer, in the price list you would go to page **529 a** and choose part number **WMASP-L10A**.

PART EXAMPLES

(Item number will be prefaced with the style.)

WMASP-L10A

Aspen, Base Unit, 2-Lateral File Drawer

WMJUS-A01B04

Justine, Top Unit, Full Height Doors, with glass doors, frosted glass.

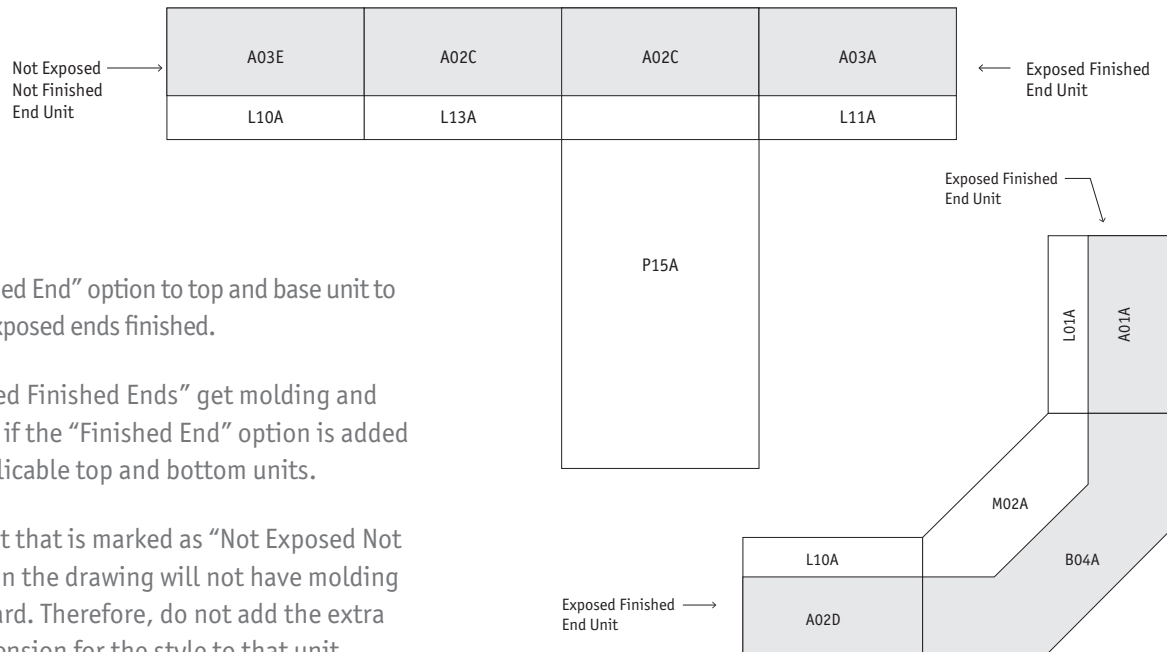
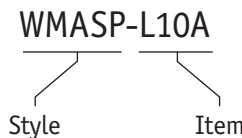

Add "Finished End" option to top and base unit to have the exposed ends finished.

All "Exposed Finished Ends" get molding and baseboard if the "Finished End" option is added to the applicable top and bottom units.

An end unit that is marked as "Not Exposed Not Finished" in the drawing will not have molding or baseboard. Therefore, do not add the extra width dimension for the style to that unit.

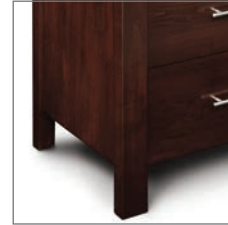

WMASP
Aspen Collection
with Inlay
Opening Shape: Straight
To account for the trim
on end cabinets:
Width: + 3"

WMLFT
Loft Collection
Opening Shape: Straight
To account for the trim
on end cabinets:
Width: + 2½"

WMJUS
Justine Collection
Opening Shape: Straight

WMESV
East Village Collection
Opening Shape: Straight
To account for the trim
on end cabinets:
Width: + ¾"



WMCBN
Colburn Collection
Opening Shape: Straight
To account for the trim
on end cabinets:
Width: + 1¾"

WMPMS
Prairie Mission
Collection
Opening Shape: Straight
To account for the trim
on end cabinets:
Width: + 1¾"

WMCLA
Classic Collection
Opening Shape: Straight
To account for the trim
on end cabinets:
Width: + 1¾"
Option:
Raised Panel Ends
Base shown with raised
panel ends option

Note: Images are shown with "Exposed Finished Ends".

Note: Our price list will show all eight styles of each unit together by page number and letter.
So for instance, to order an Aspen Base Unit, 2-Lateral File Drawer, in the price list you would go to page **529a** and choose part number **WMASP-L10A**.

STEP 2 | CHOOSE BASE UNIT

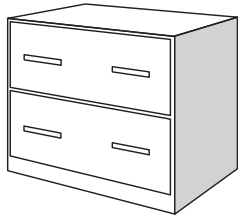

a 2-Lateral File Drawers
L10A

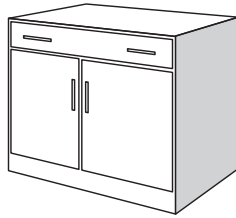

b 2-Doors and 1-Drawer
L11A

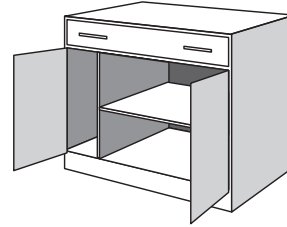

c 2-Doors with Tower Area, Convertible Drawer and Pocket Doors
L12A

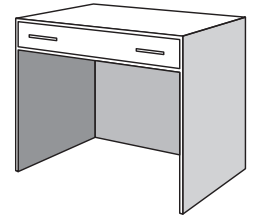

d Open with convertible drawer
L13A

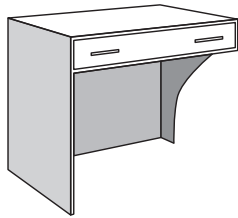

e Left Facing Open with convertible drawer cutout on right
L01A

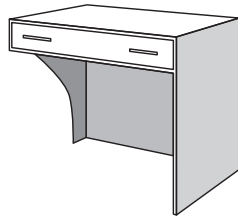

f Right Facing Open with convertible drawer cutout on left
L02A

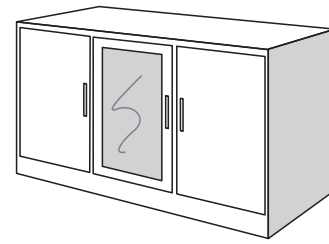

g 3-Door TV console with 2-adjustable shelves each door
Height: 31"; Depth: 24"
48"w L17A
54"w L18A
60"w L19A
72"w L20A

Standard Dimensions:
Height: 31"
Width: 36"
Depth: 24"

Standard Options:
Grommet

Glass Options:
02 - Plain
03 - Beveled (not available with mullions)
04 - Frosted
05 - Water
06 - Antique

NARROW BASE UNITS



h 21" w Base Unit with 1 File Drawer and Pullout Surface
21" w x 24" d N14A



i 21" w Base Unit with 2 file drawers
21" w x 24" d N16A

Standard Dimensions:
Height: 31"
Width: 21"
Depth: 24"

VARIABLE BRIDGE BASE UNITS

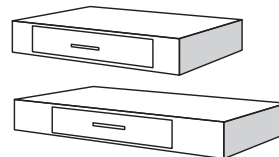

j Base Bridge Unit with Convertible Drawer
Drawer width does not change.
30" w - 42" w R06A
42" w - 48" w R07A
48" w - 54" w R08A
54" w - 60" w R09A

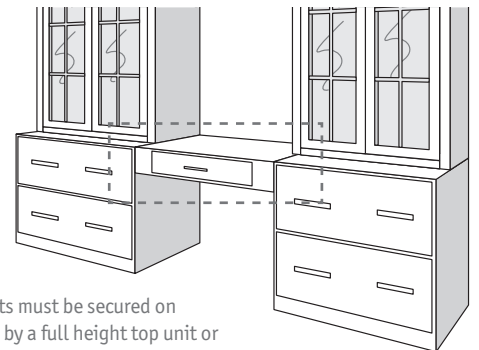

Note: Bridge units must be secured on either side by a full height top unit or bottom unit.
It is not possible to have two bridge units side by side.



Shown with Finished End Option
(Top & Bottom)

DESK RETURN UNITS

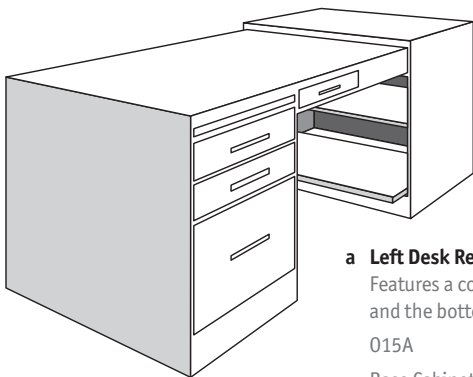

Finished End — Standard

a Left Desk Return

Features a convertible drawer and the bottom shelf pulls out.

O15A

Base Cabinet	36" w x 24" d
Desk Return	60" w x 35" d
Knee Space	30" w

Standard Dimensions:

Height:	31"
Width:	84"
Depth:	36"

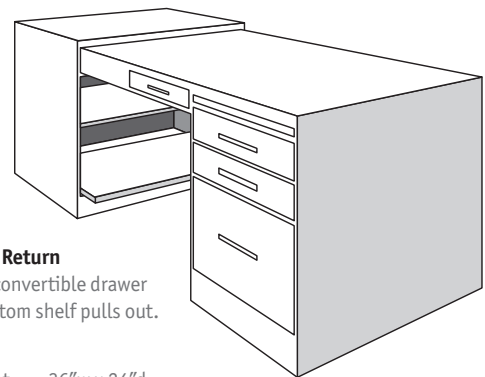

Finished End — Standard

b Right Desk Return

Features a convertible drawer and the bottom shelf pulls out.

P15A

Base Cabinet	36" w x 24" d
Desk Return	60" w x 35" d
Knee Space	30" w

Standard Options:

Grommet	SAOGM
---------	-------

LARGE CORNER DESK UNITS

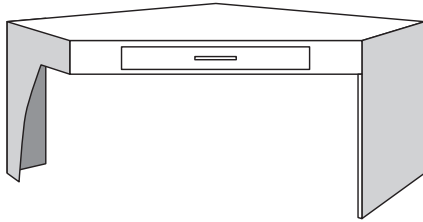

a Corner Open Left Side
(convertible drawer)
M02A

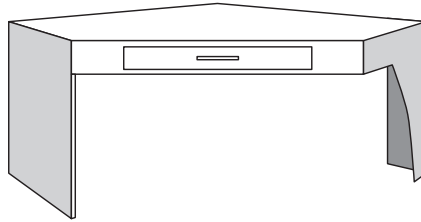

b Corner Open Right Side
(convertible drawer)
M01A

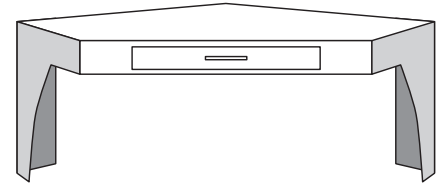

c Corner Open Both Sides
(convertible drawer)
M03A

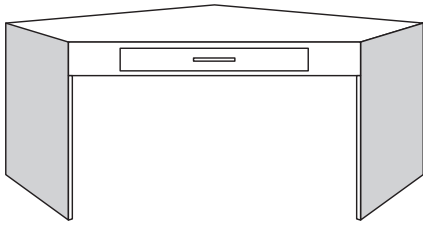

d Corner Closed Both Sides
(convertible drawer)
M13A

Standard Dimensions:
Height: 31"

Standard Options:
Grommet

Top folds to allow entry through standard doorways.

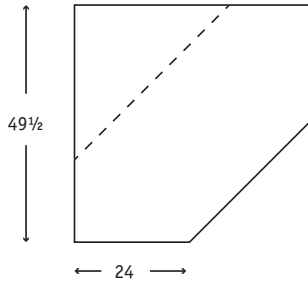

Shown without Finished End Option (Top & Bottom)

BASE TURN UNIT

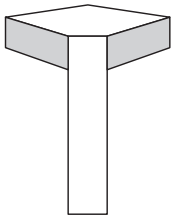

e Corner Closed Both Sides
Q05A

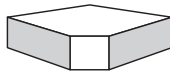

f Corner Open Both Sides
Q04A

Standard Dimensions:
Height: 31"

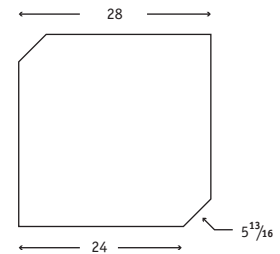

STEP 3 CHOOSE TOP

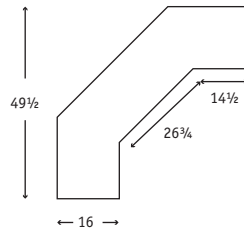
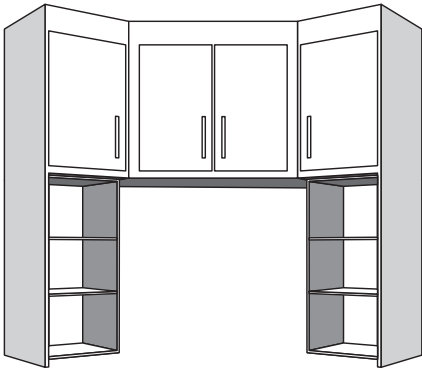

Standard Dimensions:
Height: 51"

a Top Corner with 4 Doors

B04A01



NARROW TOP UNITS

TOP TURN UNIT

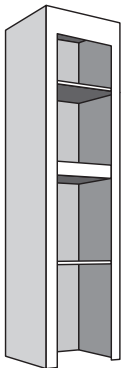

Standard Dimensions:
Height: 51"
Width: 21"
Depth: 12"

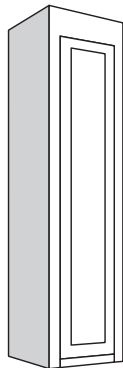

b 21" w Top Unit with 2 adjustable shelves

C03E01

c 21" w Top Unit with 1 Wood Door

C05A01

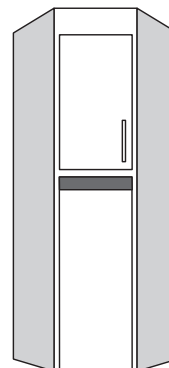

Standard Dimensions:
Height: 51"

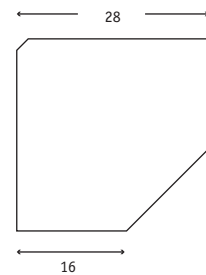

d Corner Closed Both Sides

D15A01

DESK TOP UNITS

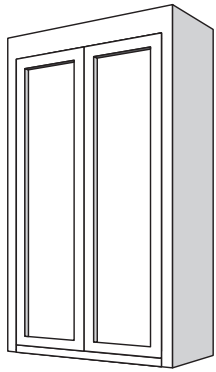

a 2 Wood Doors with 3 adjustable shelves

A01A01

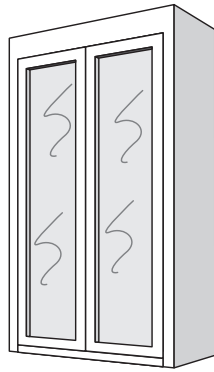

b 2 Glass Doors with 3 adjustable shelves

A01B

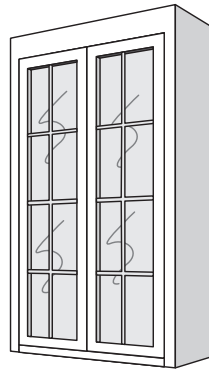

c 2 Glass Doors with Mullions and 3 adjustable shelves

A01C

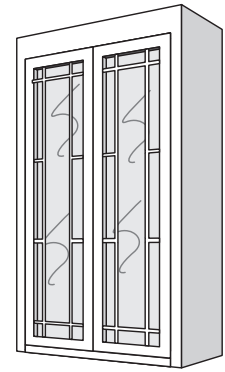

d 2 Glass Doors with Open Center Mullions and 3 adjustable shelves

A01D

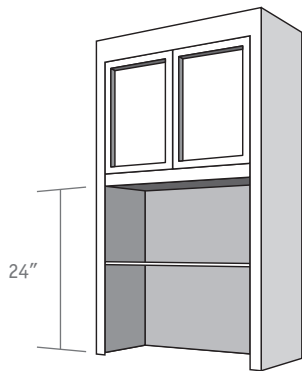

e 2 Wood Doors, Open Shelves, and 2 adjustable shelves

A02A01



f 2 Glass Doors, Open Shelves, and 2 adjustable shelves

A02B

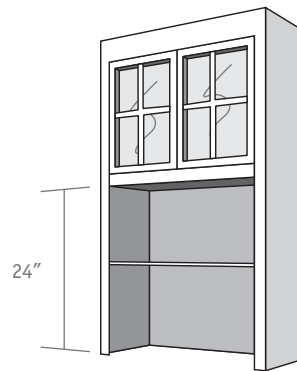

g 2 Glass Doors with Mullions, Open Shelves, and 2 adjustable shelves

A02C



h 2 Glass Doors with Double Mullions, Open Shelves, and 2 adjustable shelves

A02D

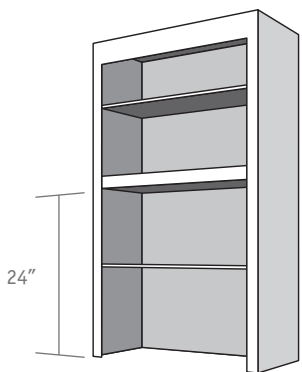

i Open Shelves with 2 adjustable shelves

A03E

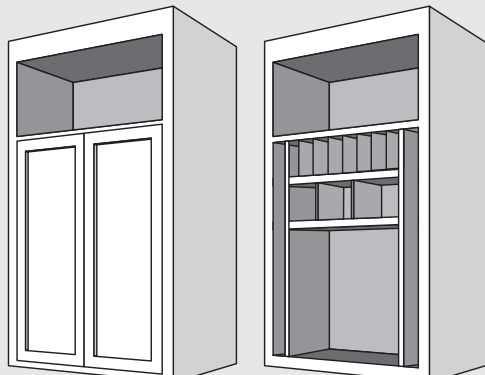

j 2 Doors with Increased Height & Depth with Pocket Doors.

A06A01

This unit is taller and deeper than all the other units.
Standard Dimensions - Height: 55", Width: 36", Depth: 24"
 Features trim on front and sides.

Applies to all on the page unless otherwise noted.

Standard Dimensions:

Height: 51"
 Width: 36"
 Depth: 12"

Standard Options:

Lights

Glass Options:

- 02 - Plain
- 03 - Beveled (not available with mullions)
- 04 - Frosted
- 05 - Water
- 06 - Antique

Note: Wood shelves are standard and glass shelves are optional.

VARIABLE BRIDGE TOP UNITS

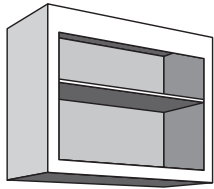

a Open Shelves and 1 Adjustable Shelf, 12" d

30" w - 42" w E07E01
 42" w - 48" w E08E01
 48" w - 54" w E09E01
 54" w - 60" w E10E01

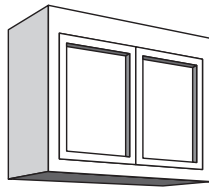

b 2 Wood Doors, 1 Adjustable Shelf, 12" d

30" w - 42" w E11A01
 42" w - 48" w E12A01

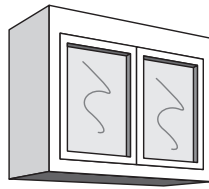

c 2 Glass Doors, 1 Adjustable Shelf, 12" d

30" w - 42" w E11B
 42" w - 48" w E12B

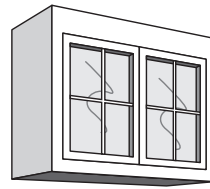

d 2 Glass Doors with Mullions, 1 Adjustable Shelf, 12" d

30" w - 42" w E11C
 42" w - 48" w E12C

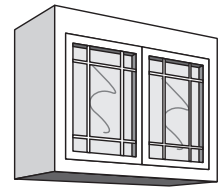

e 2 Glass Doors with Open Center Mullions, 1 Adjustable Shelf, 12" d

30" w - 42" w E11D
 42" w - 48" w E12D

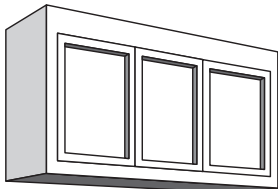

f 3 Wood Doors, 1 Adjustable Shelf, 12" d

48" w - 54" w E13A01
 54" w - 60" w E14A01

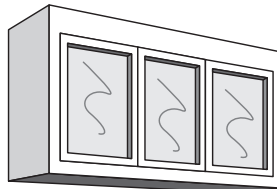

g 3 Glass Doors, 1 Adjustable Shelf, 12" d

48" w - 54" w E13B
 54" w - 60" w E14B

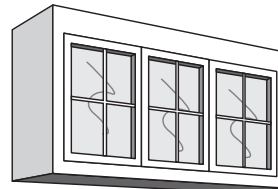

h 3 Glass Doors with Mullions, 1 Adjustable Shelf, 12" d

48" w - 54" w E13C
 54" w - 60" w E14C

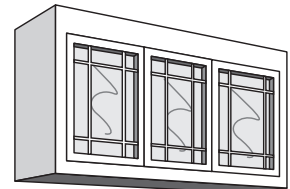

i 3 Glass Doors with Open Center Mullions, 1 Adjustable Shelf, 12" d

48" w - 54" w E13D
 54" w - 60" w E14D

Applies to all on the page unless otherwise noted.

Standard Dimensions:

Height: 27"
 Depth: 12"

Standard Options:

Lights

Glass Options:

- 02 - Plain
- 03 - Beveled (not available with mullions)
- 04 - Frosted
- 05 - Water
- 06 - Antique

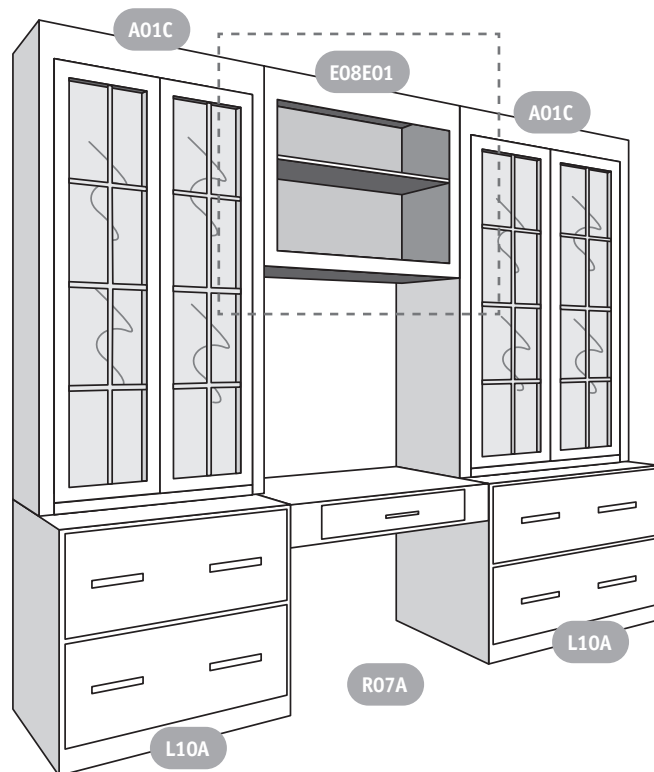

TOP UNIT FOR TV

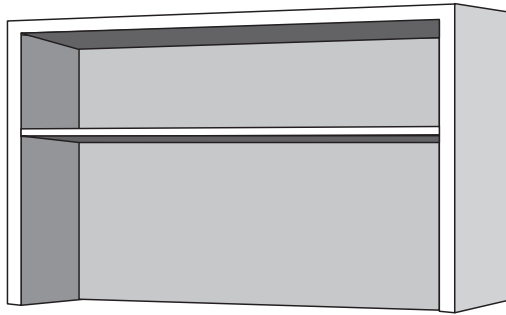

a

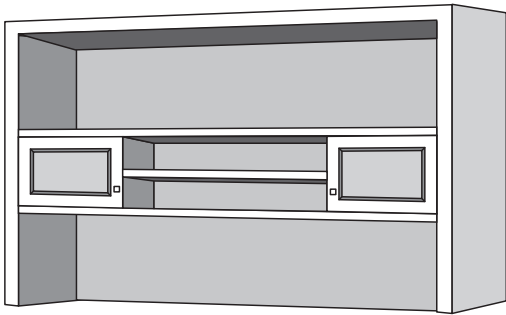

b

a Top Unit for TV

12" d x 51" h	
48" Wide with 1-Adj Shelf	A16E01
54" Wide with 1-Adj Shelf	A17E01
60" Wide with 1-Adj Shelf	A18E01
72" Wide with 1-Adj Shelf	A21E01



Shown with finished (exposed) ends.

b Top Unit for Desk

60" w x 51" h x 12" d	A19E01
72" w x 51" h x 12" d	A20E01
Features 3-LED light system	

FULL HEIGHT BOOKCASES

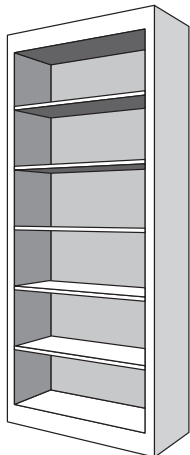

c Full height bookcase, 12" d with 5 adjustable shelves

18" w x 82" h	Z01A01
24" w x 82" h	Z02A01
30" w x 82" h	Z03A01
36" w x 82" h	Z04A01

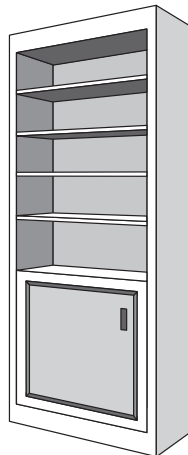

d Full height bookcase, 12" d with Wood Door on Bottom

18" w x 82" h (1 Door)	Z01B01
24" w x 82" h (1 Door)	Z02B01
30" w x 82" h (2 Doors)	Z03B01
36" w x 82" h (2 Doors)	Z04B01

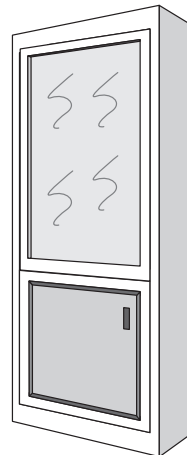

e Full height bookcase, 12" d with Glass Door on Top & Wood Door on Bottom

18" w x 82" h (1 Door)	Z01C
24" w x 82" h (1 Door)	Z02C
30" w x 82" h (2 Doors)	Z03C
36" w x 82" h (2 Doors)	Z04C

Standard Options:

Lights

Glass Options:

- 02 - Plain
- 03 - Beveled
(not available with mullions)
- 04 - Frosted
- 05 - Water
- 06 - Antique



Shown in Colburn style.



Shown in Aspen style



a

Wall Bed comes standard with Exposed Finished Ends.
Shown with Standard Lift Mechanism option (3-Year Warranty).



Wall Beds are available in Aspen, Classic, Colburn, East Village, Justine, Loft, Prairie Mission, and Sheffield styles.

Wall Beds come standard with Exposed Finished Ends. Shown with Deluxe Lift Mechanism option (3-Year Warranty). Ships in 5 pieces. Assembly required.

a Wall Bed

Queen 65" w x 89½" h x 24" d Y01C

Features LED Light System, Exposed finished ends (including trim as needed - both top & bottom) and a 3-Year Warranty on mechanism.

Deluxe Lift accept up to 10" thick mattress.

Regular Lift accept up to 8" thick mattress.



a Classic Office Base Unit #1
41" from corner; 30 $\frac{1}{4}$ "h LCM1
Convertible Drawer

b Classic Office Base Unit #2
31" w x 22 $\frac{3}{4}$ " d x 30 $\frac{1}{4}$ " h LCM2
Tower Area: 11" w x 25" h
Features tower area and two file drawers.

c Classic Office Base Unit #3
31" w x 22 $\frac{3}{4}$ " d x 30 $\frac{1}{4}$ " h LCM3
Features one drawer, two doors, and two adjustable shelves.

d Classic Office Base Unit #4
31" w x 22 $\frac{3}{4}$ " d x 30 $\frac{1}{4}$ " h LCM4
Features two lateral file drawers.

e Classic Office Top Unit #5
31" w x 12 $\frac{3}{4}$ " d x 36" h LCM5
Features one adjustable shelf.

f Classic Office Top Unit #6
Sides: 12" w x 12 $\frac{3}{4}$ " d x 36" h LCM6
Center: 24" w x 23" h

g Classic Office Top Unit #7
31" w x 12 $\frac{3}{4}$ " d x 36" h LCM7
Features plain glass doors.

h Classic Office Top Unit #8
31" w x 12 $\frac{3}{4}$ " d x 36" h LCM8
Features wood doors and one adjustable shelf.

i Classic Office Base Unit #9
31" w x 22 $\frac{3}{4}$ " d x 30 $\frac{1}{4}$ " h LCM9
Features an open knee area and convertible drawer.

j Classic Office Open Bookcase #10
31" w x 12 $\frac{3}{4}$ " d x 66 $\frac{1}{4}$ " h LCM10
Features four adjustable shelves.

k Classic Office Base Unit #11
Left LCM11L
Features kneehole cutout on left side.
Right LCM11R
Features kneehole cutout on right side.
41" from corner; 30 $\frac{1}{4}$ " h
Convertible Drawer

l Classic Office Base Unit #12
Left LCM12L
Features kneehole cutout on left side.
Right LCM12R
Features kneehole cutout on right side.
31" w x 22 $\frac{3}{4}$ " d x 30 $\frac{1}{4}$ " h

m Classic Office Base Unit #13
31" w x 22 $\frac{3}{4}$ " d x 30 $\frac{1}{4}$ " h LCM13
Features three drawers.

n Classic Office Base Unit #14
18" w x 22 $\frac{3}{4}$ " d x 30 $\frac{1}{4}$ " h LCM14
Features two file drawers.

o Classic Office Base Unit #15
31" w x 22 $\frac{3}{4}$ " d x 30 $\frac{1}{4}$ " h LCM15
Features one shelf.

p Classic Office Base Extension Unit #16
54" w x 28" d x 29 $\frac{1}{2}$ " h LCM16
Features drawers on both sides.
Must be attached to Unit #15.

q Classic Office 4-Drawer File Cabinet
18" w x 22 $\frac{3}{4}$ " d x 57" h LCM18

r Classic Office 3-Drawer File Cabinet
18" w x 22 $\frac{3}{4}$ " d x 43 $\frac{1}{2}$ " h LCM17

Additional Options:
LED task light WMOTL
Legal size file cabinet (add 3" to width) LCOLF

PRAIRIE MISSION OFFICE COLLECTION



a Prairie Mission Base Unit #1
41" from corner x 30 $\frac{3}{4}$ "h LCPM1
Convertible Drawer: 23" w x 2 $\frac{1}{2}$ " h

b Prairie Mission Base Unit #2
31" w x 22 $\frac{3}{4}$ " d x 30 $\frac{3}{4}$ " h LCPM2
Tower Area: 11" w x 25" h
Features tower area and two file drawers.

c Prairie Mission Base Unit #3
31" w x 22 $\frac{3}{4}$ " d x 30 $\frac{3}{4}$ " h LCPM3
Features one drawer, two doors, and two adjustable shelves.

d Prairie Mission Base Unit #4
31" w x 22 $\frac{3}{4}$ " d x 30 $\frac{3}{4}$ " h LCPM4
Features two lateral file drawers.

e Prairie Mission Top Unit #5
31" w x 12 $\frac{3}{4}$ " d x 36" h LCPM5
Features one adjustable shelf.

f Prairie Mission Top Unit #6
Sides: 12" w x 12 $\frac{3}{4}$ " d x 30" h LCPM6
Center: 24" w x 23" h

g Prairie Mission Top Unit #7
31" w x 12 $\frac{3}{4}$ " d x 36" h LCPM7
Features plain glass doors.

h Prairie Mission Top Unit #8
31" w x 12 $\frac{3}{4}$ " d x 36" h LCPM8
Features wood doors and one adjustable shelf.

i Prairie Mission Base Unit #9
31" w x 22 $\frac{3}{4}$ " d x 30 $\frac{3}{4}$ " h LCPM9
Features an open knee area and convertible drawer.

j Prairie Mission Bookcase Unit #10
31" w x 12 $\frac{3}{4}$ " d x 66 $\frac{1}{4}$ " h LCPM10
Features four adjustable shelves.



WORK
SYD MODULAR OFFICE

- k Prairie Mission Base Unit #11**
Left LCPM11L
Features kneehole cutout on left side.
Right LCPM11R
Features kneehole cutout on right side.
41" from corner; 30 1/4" h
Convertible Drawer
- l Prairie Mission Base Unit #12**
Left LCPM12L
Features kneehole cutout on left side.
Right LCPM12R
Features kneehole cutout on right side.
31" w x 22 3/4" d x 30 1/4" h

- m Prairie Mission Base Unit #13**
31" w x 22 3/4" d x 30 1/4" h LCPM13
Features three drawers.
- n Prairie Mission Base Unit #14**
18" w x 22 3/4" d x 30 1/4" h LCPM14
Features two file drawers.
- o Prairie Mission Base Unit #15**
31" w x 22 3/4" d x 30 1/4" h LCPM15
Features one shelf.
- p Prairie Mission Extension Unit #16**
54" w x 28" d x 29 1/2" h LCPM16
Features drawers on both sides.
Must be attached to Unit #15.

- q Prairie Mission 4-Drawer File Cabinet**
18" w x 22 3/4" d x 57" h LCPM18
- r Prairie Mission 3-Drawer File Cabinet**
18" w x 22 3/4" d x 43 1/2" h LCPM17

Additional Options:
LED task light WMOTL
Legal size file cabinet (add 3" to width) LCOLF

DESK CHAIRS

WORK



SHOWN IN CHERRY, MOCHA NUT

Desk Chair Seat

If using your own fabric please supply $\frac{3}{4}$ yd.



a



b



c



d

a B&O Railroad® Trestle Bridge Arm Desk Chair

24" w

WCTRB-01B-🍃

b Bradford Arm Desk Chair

24½" w

WCBRD-01B-🍃

c Bradley Arm Desk Chair

26¼" w

WCBRL-01B-🍃

d Grant Arm Desk Chair

24¼" w

SAGRADC-🍃

🍃 Available with wood seat, fabric cushion seat, or leather cushion seat.

Desk Chair Seat

If using your own fabric please supply ¾ yd.



a



b



c



d



e



f



g



h

Desk Chair Seat and Back

If using your own fabric please supply 2½ yd.



i



j



k



l

a Harlow Arm Desk Chair

24½" w

WCHLW-01B-🍃

b Justine Arm Desk Chair

23" w

KSJADC-🍃

c Loft Arm Desk Chair

22½" w

SALOADC-🍃

d Loft II Arm Desk Chair

24¼" w

WCLF2-01B-🍃

e MärYan Arm Desk Chair

25½" w

WCMRY-01A-🍃

f Prairie Mission Arm Desk Chair

26" w

LFSADC-🍃

g Urbandale Arm Desk Chair

24" w

KSUADC-🍃

h Urbandale II Arm Desk Chair

24" w

KSUIIADC-🍃

i Buckingham Arm Desk Chair

24½" w x 25½" d

WCBUC-01B-🍃

j Kelsey Arm Desk Chair

22" w x 28" d

SAKLA-🍃

k Patterson Arm Desk Chair

25" w x 29½" d

WCPAT-01A-🍃

l Venture Arm Desk Chair

24½" w x 24½" d

SAVNADC-🍃

🍃 Available with wood seat, fabric cushion seat, or leather cushion seat.

🍃 Available with fabric cushion seat or leather cushion seat.

ORGANIZATION

WORK



a



b



c



d



e



f

a Aspen Tall Open Bookcase with Inlay

Six Adjustable Shelves

38" w x 15" d x 80" h ECABC-OPN-3680

Five Adjustable Shelves

38" w x 15" d x 72" h ECABC-OPN-3672

b Aspen Tall Bookcase with Glass Doors on Top, Wood Doors on Bottom, and Inlay

Five Adjustable Shelves

38" w x 15" d x 80" h ECABC-GWD-3680

Four Adjustable Shelves

38" w x 15" d x 72" h ECABC-GWD-3672

c Aspen Tall Bookcase with Wood Doors on Bottom and Inlay

Five Adjustable Shelves

38" w x 15" d x 80" h ECABC-OWD-3680

Four Adjustable Shelves

38" w x 15" d x 72" h ECABC-OWD-3672

d Aspen Short Open Bookcase with Inlay

Three Adjustable Shelves

38" w x 14" d x 50" h ECABC-OPN-3650

Two Adjustable Shelves

38" w x 14" d x 40" h ECABC-OPN-3640

e Aspen Short Bookcase with Glass Doors and Inlay

Three Adjustable Shelves

38" w x 14" d x 50" h ECABC-GWD-3650

Two Adjustable Shelves

38" w x 14" d x 40" h ECABC-GWD-3640

f Aspen Short Bookcase with Wood Doors and Inlay

Three Adjustable Shelves

38" w x 14" d x 50" h ECABC-OWD-3650

Two Adjustable Shelves

38" w x 14" d x 40" h ECABC-OWD-3640

Available with Beveled, Plain, Frosted, Water, or Antique Glass.

Variety is the spice of life!

With five different styles of glass to choose from, your selection can dramatically impact the look and feel of your furniture.



Plain



Beveled



Frosted



Water



Antique



a



b



c



d



e



f

a B&O Railroad®Trestle Bridge Open Bookcase

Five Adjustable Shelves
38" w x 13 3/4" d x 80" h WOTRB-OPN-3680

Four Adjustable Shelves
38" w x 13 3/4" d x 72" h WOTRB-OPN-3672

b B&O Railroad®Trestle Bridge Bookcase with Wood Doors on Bottom

Four Adjustable Shelves
38" w x 13 3/4" d x 80" h WOTRB-WOWD-3680

Three Adjustable Shelves
38" w x 13 3/4" d x 72" h WOTRB-WOWD-3672

c Barrister Bookcase

5-Stack 36" w x 13" d x 80" h FA3680SB

4-Stack 36" w x 13" d x 65" h FA3665SB

3-Stack 36" w x 13" d x 50" h FA3650SB

2-Stack 36" w x 13" d x 35" h FA3635SB

Inside: 11 1/2" d x 12" h
Shown with leaded glass option on top.
Standard with plain glass.

Leaded Glass FA36LG
Beveled Glass FA36BG
Add per door.

d Bookcase

28 1/2" w x 12 3/4" d x 28" h IW2727BC
Features one adjustable shelf.

e Bungalow 1-Door Bookcase

33 3/4" w x 15" d x 59 3/4" h SCB1DA
Features 3 adjustable shelves and leaded glass in doors.

f Bungalow 2-Door Bookcase

60 1/2" w x 15" d x 59" h SCB2WD
Features a partition in the center, 3 adjustable shelves behind each door and leaded glass in doors.

Available with Plain, Frosted, Water, or Antique Glass. Not available with beveled glass option.

GREAT FOR ORGANIZING ALMOST ANYTHING. OPTIONS INCLUDE ADDING PLATE GROOVES, MAKING BOOKCASES INTO ONE BOLT-TOGETHER WALL UNIT, DEEPER SHELVING, OR EVEN CROWN WITH ARCH TOP MOLDING.



a Classic Tall Category I

Six Adjustable Shelves	
58" w x 14" d x 81" h	KCCBC-OPN-5480
64" w x 14" d x 81" h	KCCBC-OPN-6080
Five Adjustable Shelves	
58" w x 14" d x 72½" h	KCCBC-OPN-5472
64" w x 14" d x 72½" h	KCCBC-OPN-6072
Four Adjustable Shelves	
58" w x 14" d x 65½" h	KCCBC-OPN-5465
64" w x 14" d x 65½" h	KCCBC-OPN-6065

c Classic Tall Category III

Six Adjustable Shelves	
40" w x 14" d x 81" h	KCCBC-OPN-3680
46" w x 14" d x 81" h	KCCBC-OPN-4280
Five Adjustable Shelves	
40" w x 14" d x 72½" h	KCCBC-OPN-3672
46" w x 14" d x 72½" h	KCCBC-OPN-4272
Four Adjustable Shelves	
40" w x 14" d x 65½" h	KCCBC-OPN-3665
46" w x 14" d x 65½" h	KCCBC-OPN-4265

e Classic Short Category I

Three Adjustable Shelves	
56" w x 13" d x 53" h	KCCBC-OPN-5453
62" w x 13" d x 53" h	KCCBC-OPN-6053
Two Adjustable Shelves	
56" w x 13" d x 41" h	KCCBC-OPN-5441
62" w x 13" d x 41" h	KCCBC-OPN-6041
One Adjustable Shelf	
56" w x 13" d x 28" h	KCCBC-OPN-5428
62" w x 13" d x 28" h	KCCBC-OPN-6028

g Classic Short Category III

Three Adjustable Shelves	
38" w x 13" d x 53" h	KCCBC-OPN-3653
44" w x 13" d x 53" h	KCCBC-OPN-4253
Two Adjustable Shelves	
38" w x 13" d x 41" h	KCCBC-OPN-3641
44" w x 13" d x 41" h	KCCBC-OPN-4241
One Adjustable Shelf	
38" w x 13" d x 28" h	KCCBC-OPN-3628
44" w x 13" d x 28" h	KCCBC-OPN-4228

b Classic Tall Category II

Six Adjustable Shelves	
52" w x 14" d x 81" h	KCCBC-OPN-4880
Five Adjustable Shelves	
52" w x 14" d x 72½" h	KCCBC-OPN-4872
Four Adjustable Shelves	
52" w x 14" d x 65½" h	KCCBC-OPN-4865

d Classic Tall Category IV

Six Adjustable Shelves	
28" w x 14" d x 81" h	KCCBC-OPN-2480
Five Adjustable Shelves	
28" w x 14" d x 72½" h	KCCBC-OPN-2472
Four Adjustable Shelves	
28" w x 14" d x 65½" h	KCCBC-OPN-2465

f Classic Short Category II

Three Adjustable Shelves	
50" w x 13" d x 53" h	KCCBC-OPN-4853
Two Adjustable Shelves	
50" w x 13" d x 41" h	KCCBC-OPN-4841
One Adjustable Shelf	
50" w x 13" d x 28" h	KCCBC-OPN-4828

h Classic Short Category IV

Three Adjustable Shelves	
26" w x 13" d x 53" h	KCCBC-OPN-2453
Two Adjustable Shelves	
26" w x 13" d x 41" h	KCCBC-OPN-2441
One Adjustable Shelf	
26" w x 13" d x 28" h	KCCBC-OPN-2428

Note: Plate grooves can be added to shelves at no charge – Option: SAOPG. All Bookcases are available with doors.



a



b



c



d



e



f

- a Garrett Bookcase**
 Five Adjustable Shelves
 37" w x 13" d x 80" h WOGAR-OPN-3680
 Four Adjustable Shelves
 37" w x 13" d x 72" h WOGAR-OPN-3672
 Three Adjustable Shelves
 37" w x 13" d x 65" h WOGAR-OPN-3665

- b Imperial Open Bookcase**
 40" w x 18 1/4" d x 81 1/2" h TSIA6
 Features five adjustable shelves.

- c Imperial Bookcase with Doors on Bottom**
 40" w x 18 1/4" d x 81 1/2" h TSIA2
 Features wood doors on bottom and four adjustable shelves.

- d Justine Bookcase with Glass Doors on Top and Wood Doors on Bottom**
 Four Adjustable Shelves
 36" w x 14" d x 80" h SCJ3680WDBC
 Three Adjustable Shelves
 36" w x 14" d x 72" h SCJ3672WDBC
 Two Adjustable Shelves
 36" w x 14" d x 65" h SCJ3665WDBC

Note: See price list for available glass options.

- e Justine Open Bookcase**
 Five Adjustable Shelves
 36" w x 14" d x 80" h SCJ3680BC
 Four Adjustable Shelves
 36" w x 14" d x 72" h SCJ3672BC
 Three Adjustable Shelves
 36" w x 14" d x 65" h SCJ3665BC

- f Justine Bookcase with Wood Doors on Bottom**
 Four Adjustable Shelves
 36" w x 14" d x 80" h SCJ3680WOWD
 Three Adjustable Shelves
 36" w x 14" d x 72" h SCJ3672WOWD
 Two Adjustable Shelves
 36" w x 14" d x 65" h SCJ3665WOWD



a



b



c



d

a Loft Open Bookcase

Six Adjustable Shelves

40½" w x 15" d x 80" h MELBC3680B

Five Adjustable Shelves

40½" w x 15" d x 72" h MELBC3672B

Four Adjustable Shelves

40½" w x 15" d x 65" h MELBC3665B

b Loft Bookcase with Doors on Bottom

Five Adjustable Shelves

40½" w x 15" d x 80" h MELBC-OWD-3680

Four Adjustable Shelves

40½" w x 15" d x 72" h MELBC-OWD-3672

Three Adjustable Shelves

40½" w x 15" d x 65" h MELBC-OWD-3665

c Louis Philippe Open Bookcase

Five Adjustable Shelves

39" w x 14¾" d x 80½" h WOLPP-OPN-3680

Four Adjustable Shelves

39" w x 14¾" d x 72½" h WOLPP-OPN-3672

Three Adjustable Shelves

39" w x 14¾" d x 65½" h WOLPP-OPN-3665

d Louis Philippe Bookcase with Doors on Bottom

Five Adjustable Shelves

39" w x 14¾" d x 80½" h WOLPP-WOWD-3680

Four Adjustable Shelves

39" w x 14¾" d x 72½" h WOLPP-WOWD-3672

Three Adjustable Shelves

39" w x 14¾" d x 65½" h WOLPP-WOWD-3665



a



b



c



d



e

a MäRyan Open Bookcase

Five Adjustable Shelves

45¾" w x 15¾" d x 84" h

WOMRY-OPN-3680

Four Adjustable Shelves

45¾" w x 15¾" d x 76" h

WOMRY-OPN-3672

b MäRyan Bookcase with Doors on Bottom

Four Adjustable Shelves

45¾" w x 15¾" d x 84" h

WOMRY-WOWD-3680

Three Adjustable Shelves

45¾" w x 15¾" d x 76" h

WOMRY-WOWD-3672

c McCoy Open Bookcase

46¼" w x 16½" d x 76½" h MAMCOB

Features five adjustable shelves.

d McCoy Bookcase with Glass Doors *

Waterfall Amber Glass and Mullions - Standard

46¼" w x 16½" d x 76½" h MAMCBC

Features three adjustable glass shelves with plate grooves, 2 LED light system, and two file drawers.

Available with Waterfall Clear Glass.

e McCoy Bookcase with Wood Doors *

Waterfall Amber Glass and Mullions - Standard

46¼" w x 16½" d x 76½" h MAMCBC

Features three adjustable shelves with plate grooves, 2 LED light system, and two file drawers.

Available with Waterfall Clear Glass.



LED LIGHT SYSTEM
Indicates Built In

simplyamish



a



b



c



d

a Mission Open Bookcase

Six Adjustable Shelves	IWMBC6
38" w x 13" d x 80" h	
Five Adjustable Shelves	IWMBC5
38" w x 13" d x 72" h	
Four Adjustable Shelves	IWMBC4
38" w x 13" d x 65" h	
Three Adjustable Shelves	IWMBC3
38" w x 13" d x 52" h	
Two Adjustable Shelves	IWMBC2
38" w x 13" d x 40" h	
One Adjustable Shelf	IWMBC1
38" w x 13" d x 30" h	

b Mission Bookcase with Wood Doors on Bottom

Five Adjustable Shelves	IWMBC6
38" w x 13" d x 80" h	
Four Adjustable Shelves	IWMBC5
38" w x 13" d x 72" h	

c Prairie Mission Open Bookcase

Six Adjustable Shelves	WOPMS-OPN-3880
38" w x 13" d x 80" h	
Five Adjustable Shelves	WOPMS-OPN-3872
38" w x 13" d x 72" h	
Four Adjustable Shelves	WOPMS-OPN-3865
38" w x 13" d x 65" h	
Three Adjustable Shelves	WOPMS-OPN-3852
38" w x 13" d x 52" h	
Two Adjustable Shelves	WOPMS-OPN-3840
38" w x 13" d x 40" h	
One Adjustable Shelf	WOPMS-OPN-3830
38" w x 13" d x 30" h	

d Savannah Bookcase with Doors

43 1/4" w x 19 3/4" d x 80" h NOSVBC
 Features five adjustable wood shelves and Water Glass doors.

Note: See price list for available glass options.



a



b



c



d



e

a Shaker Wide Bookcase

Six Adjustable Shelves

37½" w x 12¾" d x 81" h KCSBC-WOPN-3680

43½" w x 12¾" d x 81" h KCSBC-WOPN-4280

Five Adjustable Shelves

37½" w x 12¾" d x 72½" h KCSBC-WOPN-3672

43½" w x 12¾" d x 72½" h KCSBC-WOPN-4272

Four Adjustable Shelves

37½" w x 12¾" d x 65½" h KCSBC-WOPN-3665

43½" w x 12¾" d x 65½" h KCSBC-WOPN-4265

b Shaker Narrow Bookcase

Six Adjustable Shelves

25½" w x 12¾" d x 81" h KCSBC-NOPN-2480

Five Adjustable Shelves

25½" w x 12¾" d x 72½" h KCSBC-NOPN-2472

Four Adjustable Shelves

25½" w x 12¾" d x 65½" h KCSBC-NOPN-2465

c Shaker Wide Bookcase with Glass Doors on Top and Wood Doors on Bottom

Five Adjustable Shelves

37½" w x 12¾" d x 81" h KCSBC-WGWD-3680

43½" w x 12¾" d x 81" h KCSBC-WGWD-4280

Four Adjustable Shelves

37½" w x 12¾" d x 72½" h KCSBC-WGWD-3672

43½" w x 12¾" d x 72½" h KCSBC-WGWD-4272

Three Adjustable Shelves

37½" w x 12¾" d x 65½" h KCSBC-WGWD-3665

43½" w x 12¾" d x 65½" h KCSBC-WGWD-4265

Shaker Wide Bookcase with Wood Doors on Bottom (not shown)

Five Adjustable Shelves

37½" w x 12¾" d x 81" h KCSBC-WOWD-3680

43½" w x 12¾" d x 81" h KCSBC-WOWD-4280

Four Adjustable Shelves

37½" w x 12¾" d x 72½" h KCSBC-WOWD-3672

43½" w x 12¾" d x 72½" h KCSBC-WOWD-4272

Three Adjustable Shelves

37½" w x 12¾" d x 65½" h KCSBC-WOWD-3665

43½" w x 12¾" d x 65½" h KCSBC-WOWD-4265

d Shaker Narrow Bookcase with Glass Door on Top and Wood Door on Bottom

Five Adjustable Shelves

25½" w x 12¾" d x 81" h KCSBC-NGWD-2480

Four Adjustable Shelves

25½" w x 12¾" d x 72½" h KCSBC-NGWD-2472

Three Adjustable Shelves

25½" w x 12¾" d x 65½" h KCSBC-NGWD-2465

Shaker Narrow Bookcase with Wood Door on Bottom (not shown)

Five Adjustable Shelves

25½" w x 12¾" d x 81" h KCSBC-NOWD-2480

Four Adjustable Shelves

25½" w x 12¾" d x 72½" h KCSBC-NOWD-2472

Three Adjustable Shelves

25½" w x 12¾" d x 65½" h KCSBC-NOWD-2465

e Shenandoah Open Bookcase

Five Adjustable Shelves

37" w x 13" d x 80" h WOSHS-OPN-3680

Four Adjustable Shelves

37" w x 13" d x 72" h WOSHS-OPN-3672

Three Adjustable Shelves

37" w x 13" d x 65" h WOSHS-OPN-3665

Note: See price list for available glass options.



a



b



c

a Aspen File Cabinet with Inlay

4-Drawer	24" w x 26" d x 62 3/4" h	ECAFC4D
3-Drawer	24" w x 26" d x 49" h	ECAFC3D
2-Drawer	24" w x 26" d x 35 1/2" h	ECAFC2D
Lateral	40" w x 23" d x 35 1/2" h	ECALFC2D

b Classic File Cabinet

4-Drawer	20" w x 27" d x 58 1/2" h
Raised-Panel End	WSFC4DR
Plain End	WSFC4D
3-Drawer	20" w x 27" d x 45" h
Raised-Panel End	WSFC3DR
Plain End	WSFC3D
2-Drawer	20" w x 27" d x 31 1/2" h
Raised-Panel End	WSFC2DR
Plain End	WSFC2D
Lateral	38" w x 21" d x 31 1/2" h
Raised-Panel End	WSLFC2DR
Plain End	WSLFC2D

c Loft File Cabinet

4-Drawer	24" w x 28" d x 59 1/2" h	NOLOFC4D
3-Drawer	24" w x 28" d x 46" h	NOLOFC3D
2-Drawer	24" w x 28" d x 32 3/4" h	NOLOFC2D
Lateral	40" w x 22" d x 32 3/4" h	NOLOLFC2D

Note: Lateral drawers load side to side. Regular drawers load front to back. Backs are unfinished.



a



b



c

d

e

f

g

a Prairie Mission File Cabinet

4-Drawer	19¼" w x 27" d x 57" h	WSPM4D
3-Drawer	19¼" w x 27" d x 44" h	WSPM3D
2-Drawer	19¼" w x 27" d x 31" h	WSPM2D
Lateral	37¼" w x 21" d x 31" h	WSPMLF

b Savannah File Cabinet

4-Drawer	24" w x 28" d x 62" h	NOSVFC4D
3-Drawer	24" w x 28" d x 49" h	NOSVFC3D
2-Drawer	24" w x 28" d x 35" h	NOSVFC2D
Lateral	40" w x 22" d x 35" h	NOSVLC2D

c Colburn File Cabinet

4-Drawer	20½" w x 25" d x 58½" h	WFCBN-01D
3-Drawer	20½" w x 25" d x 45" h	WFCBN-01C
2-Drawer	20½" w x 25" d x 31½" h	WFCBN-01B
Lateral	38" w x 19" d x 31½" h	WFCBN-02B

d Garrett File Cabinet

4-Drawer	22½" w x 25" d x 60¼" h	WFGAR-01D
3-Drawer	22½" w x 25" d x 47¼" h	WFGAR-01C
2-Drawer	22½" w x 25" d x 33¼" h	WFGAR-01B

e Justine File Cabinet

4-Drawer	20¼" w x 24" d x 58" h	DLJUFC40
3-Drawer	20¼" w x 24" d x 45" h	DLJUFC30
2-Drawer	20¼" w x 24" d x 32" h	DLJUFC20
Lateral	40" w x 18" d x 32" h	DLJULFC

f MäRyán File Cabinet

4-Drawer	29½" w x 31" d x 65" h	NW MDF4
3-Drawer	29½" w x 31" d x 51½" h	NW MDF3
2-Drawer	29½" w x 31" d x 38" h	NW MDF2
Lateral	40" w x 21" d x 38" h	NW MDF2L

g Shenandoah File Cabinet

4-Drawer	22" w x 25" d x 61¼" h	WFSHS-01D
3-Drawer	22" w x 25" d x 48¼" h	WFSHS-01C
2-Drawer	22" w x 25" d x 34¼" h	WFSHS-01B

Note: Lateral drawers load side to side. Regular drawers load front to back. Backs are unfinished.

ASPEN

EXPRESS SLEEP



SHOWN IN CHERRY, MICHAEL'S



a





b



a Aspen Panel Bed with Inlay

Wood: Cherry; Finish: Michael's

Headboard: 51" h; Footboard: 31" h

King 82" w x 89" d XC26-SBASP-05B2  

QSC-SBASP-05B2 

Queen 66" w x 89" d XC26-SBASP-05B3  

QSC-SBASP-05B3 



b Aspen Panel Headboard with Wood Frame and Inlay

Wood: Cherry; Finish: Michael's

Headboard: 51" h; Wood Frame: 13½" h

King 82" w x 87" d XC26-SBASP-05W2  

QSC-SBASP-05W2 

Queen 66" w x 87" d XC26-SBASP-05W3  

QSC-SBASP-05W3 

GARRETT

EXPRESS SLEEP



SHOWN IN CHERRY, MOCHA NUT



a



b

a Garrett Headboard with Wood Frame

Wood: Cherry; Finish: Mocha Nut
Headboard: 48" h; Footboard: 13½" h

CA King	79½" w x 87¾" d	XC30-SBGAR-05W1
		QSC-SBGAR-05W1
King	83½" w x 83¾" d	XC30-SBGAR-05W2
		QSC-SBGAR-05W2
Queen	67½" w x 83¾" d	XC30-SBGAR-05W3
		QSC-SBGAR-05W3
Full	61½" w x 79¾" d	XC30-SBGAR-05W4
		QSC-SBGAR-05W4
Twin	46½" w x 79¾" d	XC30-SBGAR-05W5
		QSC-SBGAR-05W5

b Garrett 7-Drawer Dresser

Wood: Cherry; Finish: Mocha Nut
58" w x 18½" d x 36" h

XC30-SSGAR-08G2
QSC-SSGAR-08G2

Garrett Dresser Mirror

Wood: Cherry; Finish: Mocha Nut
40½" w x 1½" d x 37¼" h

XC30-SMGAR-06A2
QSC-SMGAR-06A2



Nickel Pulls
70-A-31



a



b



c



d

a Garrett Mule Chest

Wood: Cherry; Finish: Mocha Nut
54" w x 18½" d x 44" h XC30-SSGAR-11J0 ⇄
QSC-SSGAR-11J0 ⇄

Garrett Mule Chest Mirror

Wood: Cherry; Finish: Mocha Nut
44½" w x 1½" d x 30¼" h XC30-SMGAR-08A0 ⇄
QSC-SMGAR-08A0 ⇄

b Garrett 6-Drawer Chest

Wood: Cherry; Finish: Mocha Nut
36" w x 18½" d x 52" h XC30-SSGAR-04F0 ⇄
QSC-SSGAR-04F0 ⇄

c Garrett Nightstand with Drawers

Wood: Cherry; Finish: Mocha Nut
22" w x 18½" d x 27½" h XC30-SNGAR-02C1 ⇄
QSC-SNGAR-02C1 ⇄

d Garrett Nightstand with Opening on Bottom

Wood: Cherry; Finish: Mocha Nut
22" w x 18½" d x 27½" h XC30-SNGAR-04A1 ⇄
QSC-SNGAR-04A1 ⇄

LOFT

EXPRESS SLEEP



SHOWN IN CHERRY, BOURBON







a



b





a Loft II Panel Bed

Wood: Cherry; Finish: Bourbon
Headboard: 55"h; Footboard: 33"h

King	82¾" w x 85" d	XC28-SBLF2-05B2 
		QSC-SBLF2-05B2 
Queen	66¾" w x 85" d	XC28-SBLF2-05B3 
		QSC-SBLF2-05B3 

b Loft II Panel Headboard with Wood Frame

Wood: Cherry; Finish: Bourbon
Headboard: 55"h; Footboard: 13½"h

King	82¾" w x 85" d	XC28-SBLF2-05W2 
		QSC-SBLF2-05W2 
Queen	66¾" w x 85" d	XC28-SBLF2-05W3 
		QSC-SBLF2-05W3 



Nickel Pulls
70-E-10



a



b



c



d

a Loft 12-Drawer Bureau, Medium

Wood: Cherry; Finish: Bourbon
60" w x 21¼" d x 47¾" h
XC28-MEL43-60B ⇄
QSC-MEL43-60B ⇄

Loft Bureau Mirror, Medium

Wood: Cherry; Finish: Bourbon
54½" w x 27" h
XC28-MELSBM ⇄
QSC-MELSBM ⇄

Features a beveled edge mirror.

b Loft 6-Drawer Chest

Wood: Cherry; Finish: Bourbon
40" w x 21½" d x 49" h
XC28-MEL15CD ⇄
QSC-MEL15CD ⇄

c Loft Jewelry Armoire

Wood: Cherry; Finish: Bourbon
22" w x 14¾" d x 48¾" h
XC28-MSLJA ⇄
QSC-MSLJA ⇄

Features flip-top mirror and black nylon velvet interior. Sides open for necklace storage.

d Loft Nightstand with Drawers

Wood: Cherry; Finish: Bourbon
23" w x 15½" d x 28¼" h
XC28-MEL19BC ⇄
QSC-MEL19BC ⇄

SHENANDOAH

EXPRESS SLEEP



SHOWN IN CHARACTER CHERRY, MICHAEL'S



a



b



c Comes standard with WK-A-05 hardware.

a Shenandoah Headboard with Wood Frame

Wood: Character Cherry; Finish: Michael's
Headboard: 48" h; Footboard: 13½" h

CA King	78" w x 87½" d	XK26-SBSHS-05W1	⇒
		QSK-SBSHS-05W1	⇒
King	82" w x 83½" d	XK26-SBSHS-05W2	⇒
		QSK-SBSHS-05W2	⇒
Queen	66" w x 83½" d	XK26-SBSHS-05W3	⇒
		QSK-SBSHS-05W3	⇒
Full	60" w x 79½" d	XK26-SBSHS-05W4	⇒
		QSK-SBSHS-05W4	⇒
Twin	45" w x 79½" d	XK26-SBSHS-05W5	⇒
		QSK-SBSHS-05W5	⇒

b Shenandoah Deluxe Headboard with Wood Frame

Wood: Character Cherry; Finish: Michael's
Headboard: 59¼" h; Footboard: 13½" h

CA King	81" w x 87½" d	XK26-SBSHD-05W1	⇒
		QSK-SBSHD-05W1	⇒
King	85" w x 83½" d	XK26-SBSHD-05W2	⇒
		QSK-SBSHD-05W2	⇒
Queen	69" w x 83½" d	XK26-SBSHD-05W3	⇒
		QSK-SBSHD-05W3	⇒
Full	63" w x 79½" d	XK26-SBSHD-05W4	⇒
		QSK-SBSHD-05W4	⇒
Twin	48" w x 79½" d	XK26-SBSHD-05W5	⇒
		QSK-SBSHD-05W5	⇒

c Shenandoah Bed with Under-Bed Storage

Wood: Character Cherry; Finish: Michael's
Rail Top: 20"; Rail Bottom: 5½" from floor
Mattress Sits 2" Lower than Rail Top

King	82" w x 83½" d	XK26-SBSHS-16U2	⇒
		QSK-SBSHS-16U2	⇒
Queen	66" w x 83½" d	XK26-SBSHS-16U3	⇒
		QSK-SBSHS-16U3	⇒

Note: Comes complete with Headboard, Footboard, and Under-Bed Storage with two drawers on each side.

Standard Hardware Options

Choose one of the three hardware pieces pictured.

MEX-WK-A-05 standard unless otherwise specified.



MEX-WK-A-05



MEX-70-B-01



MEX-WK-A-01



Character Cherry & QSWO
Sides/Bases Open Knots Standard



Character Cherry & QSWO
Table Tops Filled Knots Standard
Case Goods Tops Filled Knots Standard
Chair Seats Filled Knots Standard



a Comes standard with WK-A-05 hardware.



b



c



d



e



f



g

a Shenandoah Deluxe Bed with Under-Bed Storage

Wood: Character Cherry; Finish: Michael's Rail Top: 20"; Rail Bottom: 5½" from floor
Mattress Sits 2" Lower than Rail Top

King 86"w x 84"d XK26-SBSHD-16U2
QSK-SBSHD-16U2

Queen 70"w x 84"d XK26-SBSHD-16U3
QSK-SBSHD-16U3

Note: Comes complete with Headboard, Footboard, and Under-Bed Storage with two drawers on each side.

b Shenandoah Mule Chest

Wood: Character Cherry; Finish: Michael's 54"w x 18"d x 44½"h XK26-SSSHS-11J0
QSK-SSSHS-11J0

Shenandoah Mule Chest Mirror

Wood: Character Cherry; Finish: Michael's 42"w x 1½"d x 34½"h XK26-SMSHS-08A0
QSK-SMSHS-08A0

Features beveled edge mirror

c Shenandoah 7-Drawer Dresser

Wood: Character Cherry; Finish: Michael's 58"w x 18"d x 36"h XK26-SSSHS-08G2
QSK-SSSHS-08G2

Shenandoah Dresser Mirror

Wood: Character Cherry; Finish: Michael's 38½"w x 2½"d x 41½"h XK26-SMSHS-10A2
QSK-SMSHS-10A2

Features beveled edge mirror

d Shenandoah 6-Drawer Chest

Wood: Character Cherry; Finish: Michael's 36"w x 18"d x 52"h XK26-SSSHS-04FO
QSK-SSSHS-04FO

e Shenandoah Lingerie Chest

23"w x 18"d x 52"h XK26-SSSHS-15E
QSK-SSSHS-15E

f Shenandoah Nightstand with Drawers

Wood: Character Cherry; Finish: Michael's 22"w x 18"d x 27½"h XK26-SNSHS-02C1
QSK-SNSHS-02C1

g Shenandoah Nightstand with Opening on Bottom

Wood: Character Cherry; Finish: Michael's 22"w x 18"d x 27½"h XK26-SNSHS-04A1
QSK-SNSHS-04A1

SAN MIGUEL

EXPRESS SLEEP



SHOWN IN CHARACTER QUARTERSAWN WHITE OAK, MICHAEL'S



a



b

a San Miguel Panel Headboard with Wood Frame

Wood: Character QSWO; Finish: Michael's
Headboard: 48" h; Footboard: 13½" h

CA King 82" w x 88" d	XN26-SBMIG-05W1	⇒
	QSN-SBMIG-05W1	⇒
King 86" w x 84" d	XN26-SBMIG-05W2	⇒
	QSN-SBMIG-05W2	⇒
Queen 70" w x 84" d	XN26-SBMIG-05W3	⇒
	QSN-SBMIG-05W3	⇒
Full 64" w x 80" d	XN26-SBMIG-05W4	⇒
	QSN-SBMIG-05W4	⇒
Twin 49" w x 80" d	XN26-SBMIG-05W5	⇒
	QSN-SBMIG-05W5	⇒

b San Miguel 7-Drawer Dresser

Wood: Character QSWO; Finish: Michael's
58" w x 18½" d x 36" h

XN26-SSMIG-08G1 ⇒
QSN-SSMIG-08G1 ⇒

San Miguel Dresser Mirror

Wood: Character QSWO; Finish: Michael's
42½" w x 2½" d x 37½" h

XN26-SMMIG-06A2 ⇒
QSN-SMMIG-06A2 ⇒



Black Mission Pull
61-A-03



Character Cherry & QSWO
Sides/Bases Open Knots Standard



Character Cherry & QSWO
Table Tops Filled Knots Standard
Case Goods Tops Filled Knots Standard
Chair Seats Filled Knots Standard



a



b



c



d

Character Quartersawn White Oak is only available on the San Miguel Collection and San Miguel Express items at this time.

a San Miguel Mule Chest

Wood: Character QSWO; Finish: Michael's
54" w x 18 1/4" d x 44 1/4" h XN26-SSMIG-11J0 ⇄
QSN-SSMIG-11J0 ⇄

San Miguel Mule Chest Mirror

Wood: Character QSWO; Finish: Michael's
46 1/2" w x 2 1/2" d x 31" h XN26-SMMIG-08A0 ⇄
QSN-SMMIG-08A0 ⇄

b San Miguel 6-Drawer Chest

Wood: Character QSWO; Finish: Michael's
36" w x 18 1/2" d x 52" h XN26-SSMIG-04F0 ⇄
QSN-SSMIG-04F0 ⇄

c San Miguel Nightstand with Opening

Wood: Character QSWO; Finish: Michael's
22" w x 18 1/2" d x 27 1/2" h XN26-SNMIG-04A1 ⇄
QSN-SNMIG-04A1 ⇄

d San Miguel Nightstand with Drawers

Wood: Character QSWO; Finish: Michael's
22" w x 18 1/2" d x 27 1/2" h XN26-SNMIG-02C1 ⇄
QSN-SNMIG-02C1 ⇄

McCoy

EXPRESS SLEEP



SHOWN IN QUARTERSAWN WHITE OAK, MICHAEL'S



a

a McCoy Panel Bed

Wood: Quartersawn; Finish: Michael's
 Headboard: 50"h; Footboard: 28"h

- | | | |
|-------|--------------|-------------------|
| King | 82½"w x 92"d | XQ26-SBMCC-05B2 ➡ |
| | | QSQ-SBMCC-05B2 ➡ |
| Queen | 66½"w x 92"d | XQ26-SBMCC-05B3 ➡ |
| | | QSQ-SBMCC-05B3 ➡ |

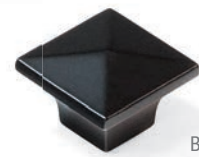

Black Metal Knobs
WK-A-07



a





b





c



a McCoy 12-Drawer Bureau

Wood: Quartersawn; Finish: Michael's
62" w x 23½" d x 48¾" h XQ26-MEM43-62B 
QSQ-MEM43-62B 



McCoy Bureau Mirror

Wood: Quartersawn; Finish: Michael's
57¾" w x 4½" d x 27" h XQ26-MEMSBM 
QSQ-MEMSBM 

b McCoy 6-Drawer Chest

Wood: Quartersawn; Finish: Michael's
42" w x 23½" d x 50¼" h XQ26-MEM15CD 
QSQ-MEM15CD 

c McCoy Nightstand with Drawers

Wood: Quartersawn; Finish: Michael's
22¼" w x 17½" d x 28" h XQ26-MEM19BC 
QSQ-MEM19BC 

SHENANDOAH

EXPRESS EAT



SHOWN IN CHARACTER CHERRY, MICHAEL'S



a

SATE-10
Large Roundover Edge



b

SATE-60
Large Bevel Edge

a Shenandoah Leg Table

Wood: Character Cherry; Finish: Michael's

Edge: SATE-10

13/16" thick top – standard.

40" w x 60" l

XK26-ETSHS-J04A07C 

40" w x 60" l

QSK-ETSHS-J04A07C 

Features 2½" x 2½" small square tapered legs and two 12" leaves.

b Shenandoah Trestle Table

Wood: Character Cherry; Finish: Michael's;

Edge: SATE-60

13/16" thick top – standard.

42" w x 72" l

XK26-ETSHS-H07F16E 

42" w x 72" l

QSK-ETSHS-H07F16E 

Features four 12" leaves.

Two leaves self store, no aprons.

Other two leaves with aprons do not self store.

Standard Hardware Options

Choose one of the three hardware pieces pictured.

MEX-WK-A-05 standard unless otherwise specified.



MEX-WK-A-05



MEX-70-B-01



MEX-WK-A-01



Character Cherry & QSWO
Sides/Bases Open Knots Standard



Character Cherry & QSWO
Table Tops Filled Knots Standard
Case Goods Tops Filled Knots Standard
Chair Seats Filled Knots Standard



a

SATE-40
Small Roundover Edge



b



c



d



e



f



g



h

a Shenandoah Round Table

Wood: Character Cherry; Finish: Michael's;
Edge: SATE-40

13/16" thick top – standard.

48" Round

XK26-ETSHS-F06D22C ⇄

QSK-ETSHS-F06D22C ⇄

Features two 12" leaves.

b Shenandoah 2-Door Sideboard

Wood: Character Cherry; Finish: Michael's

46" w x 18" d x 36 1/2" h

XK26-ESSHS-D18 ⇄

QSK-ESSHS-D18 ⇄

Features one full-width adjustable shelf.

c Shenandoah 3-Door Sideboard

Wood: Character Cherry; Finish: Michael's

54" w x 18" d x 36 1/2" h

XK26-ESSHS-D17 ⇄

QSK-ESSHS-D17 ⇄

Features one full-width adjustable shelf.

d Shenandoah Dining Trestle Bench

72" w x 17" d x 18" h

XK26-ECSHS-13D-W ⇄

QSK-ECSHS-13D-W ⇄

e Wright Side Chair

Wood: Character Cherry; Finish: Michael's

18 1/2" w x 22 3/4" d x 37 3/4" h

XK26-ECWRI-02A-W ⇄

QSK-ECWRI-02A-W ⇄

f Mitchell Side Chair

Wood: Character Cherry; Finish: Michael's

19" w x 21" d x 38 3/4" h

XK26-ECMIT-02A-W ⇄

QSK-ECMIT-02A-W ⇄

g Sheffield Side Chair

Wood: Character Cherry; Finish: Michael's

18 3/4" w x 22 3/4" d x 38" h

XK26-SPSHS-W ⇄

QSK-SPSHS-W ⇄

h Clifton Side Chair

Wood: Character Cherry; Finish: Michael's

18" w x 21 1/2" d x 39 1/2" h

XK26-ECCLI-02A-W ⇄

QSK-ECCLI-02A-W ⇄

SHENANDOAH

EXPRESS EAT



SHOWN IN SOFT MAPLE, BOURBON



Shown with leaves.

a Shenandoah Leg Table

Wood: Soft Maple; Finish: Bourbon

Two 12" Leaves, Edge: SATE-10

13/16" thick top – standard.

40" w x 60" l

XS28-ETSHS-J04A07C 

QSS-ETSHS-J04A07C 

Features 2½" x 2½" small square tapered legs and ball bearing slides.



a



b

c



d

e

f

a Bradford Chair

Wood: Soft Maple; Finish: Bourbon

Arm chair	Arm Height: 25 $\frac{1}{4}$ "h
23 $\frac{3}{4}$ "w x 23 $\frac{3}{4}$ "d x 40"h	XS28-ECBRD-01A-W
	QSS-ECBRD-01A-W

Side chair	
18 $\frac{1}{2}$ "w x 23 $\frac{3}{4}$ "d x 40"h	XS28-ECBRD-02A
	QSS-ECBRD-02A

b Wright Side Chair

Wood: Soft Maple; Finish: Bourbon

18 $\frac{1}{2}$ "w x 22 $\frac{3}{4}$ "d x 37 $\frac{3}{4}$ "h	XS28-ECWRI-02A-W
	QSS-ECWRI-02A-W

c Sheffield Side Chair

Wood: Soft Maple; Finish: Bourbon

18 $\frac{3}{4}$ "w x 22 $\frac{1}{4}$ "d x 38"h	XS28-SPSHS-W
	QSS-SPSHS-W

d Mitchell Side Chair

Wood: Soft Maple; Finish: Bourbon

19"w x 21"d x 38 $\frac{3}{4}$ "h	XS28-ECMIT-02A-W
	QSS-ECMIT-02A-W

e Waveland Side Chair

Wood: Soft Maple; Finish: Bourbon

19"w x 21"d x 38 $\frac{3}{4}$ "h	XS28-ECWAV-02A-W
	QSS-ECWAV-02A-W

f Sally Stationary Barstool

16"w x 12"d x 24"h	XS28-ECSAL-04C
16"w x 12"d x 30"h	XS28-ECSAL-04B
16"w x 12"d x 24"h	QSS-ECSAL-04C
16"w x 12"d x 30"h	QSS-ECSAL-04B

B&O RAILROAD[®]

EXPRESS EAT



SHOWN IN CHARACTER CHERRY, TOBACCO WITH OLDE WORLD AGING



SATE-80
Medium Roundover

a

Features an 18" stationary butterfly leaf on each end.

a B&O Railroad[®] Trestle Bridge Trestle Table

Wood: Character Cherry; Finish: Tobacco (Olde World)

Features 1-18" butterfly leaf on each end.

1" thick plank top - standard.

42" w x 72" l XK35A2-ETTRB-H14D16Q 

QSK-ETTRB-H14D16Q 

Table features Olde World A.



Hand Forged Black Pulls
66-I-02



a Features Planked Top



b Features Planked Top

<p>Character Cherry & QSWO Sides/Bases Open Knots Standard</p>	<p>Character Cherry & QSWO Table Tops Filled Knots Standard Case Goods Tops Filled Knots Standard Chair Seats Filled Knots Standard</p>



c

- a B&O Railroad® Trestle Bridge Sideboard**
Wood: Character Cherry; Finish: Tobacco (Olde World)
60" w x 19" d x 36½" h XK35A2-ESTRB-D11 →
QSK-ESTRB-D11 →
- Features open space behind doors and Olde World A.
Planked top standard.
- b B&O Railroad® Trestle Bridge Dining Bench**
Wood: Character Cherry; Finish: Tobacco (Olde World)
72" w x 17" d x 18" h XK35B2-ECTR-B-12D-W →
QSK-ECTR-B-12D-W →
- Features Olde World B.
Planked top standard.

- c B&O Railroad® Trestle Bridge Chair**
Wood: Character Cherry; Finish: Tobacco (Olde World)
- | | |
|-------------------------|---|
| Arm chair | Arm height: 25" h |
| 24" w x 24½" d x 42" h | XK35B2-ECTR-B-01A-W →
QSK-ECTR-B-01A-W → |
| Side chair | |
| 21½" w x 24½" d x 42" h | XK35B2-ECTR-B-02A-W →
QSK-ECTR-B-02A-W → |
- Features Olde World B.

LOFT

EXPRESS EAT



SHOWN IN SOFT MAPLE, BOURBON



a



b



Features an 18" stationary butterfly leaf on each end.



c



a Loft II Leg Table

Wood: Cherry or Soft Maple,
2 Self-Storing Leaves (1 with Apron, 1 without),
Edge: SATE-80, Empire top, 42" w x 72" l
13/16" thick top – standard.

Cherry QSC-ETL02-J05H16C 
Soft Maple QSS-ETL02-J05H16C 

b Alexandria Trestle Table

Wood: Cherry or Soft Maple,
18" stationary butterfly leaf on each end,
Edge: SATE-40, 42" w x 80" l
1" thick top – standard.

Cherry QSC-ETALE-H01D44Q 
Soft Maple QSS-ETALE-H01D44Q 

c Lincoln Chair

Arm Chair Arm Height: 25½" h
22" w x 24" d x 39" h

Cherry QSC-ECLCN-01A-W 
Soft Maple QSS-ECLCN-01A-W 

Side Chair

18½" w x 24" d x 39" h

Cherry QSC-ECLCN-02A-W 
Soft Maple QSS-ECLCN-02A-W 



SATE-60
Large Bevel

a



SATE-60
Large Bevel

b



c



d



EXPRESS

EAT

a Grace Double Pedestal Table

Wood: Soft Maple; Finish: Bourbon
1" thick top – standard.

42" w x 72" l XS28-ETGRC-G05F16E
QSS-ETGRC-G05F16E

Features two 12" self-storing leaves (no aprons), empire top shape, SATE-60 edge and ball bearing slides.

b Loft II Round Table

Wood: Soft Maple; Finish: Bourbon
Edge: SATE-60
1" thick top – standard.

48" Round XS28-NBL4848-2
QSS-NBL4848-2

Features two 12" leaves.

c Bradford Chair

Wood: Soft Maple; Finish: Bourbon

Arm chair Arm Height: 25 1/4" h
23 3/4" w x 23 3/4" d x 40" h XS28-ECBRD-01A-W
QSS-ECBRD-01A-W

Side chair
18 1/2" w x 23 3/4" d x 40" h XS28-ECBRD-02A
QSS-ECBRD-02A

d Loft II Chair

Wood: Soft Maple; Finish: Bourbon

Arm chair Arm Height: 26" h
24" w x 24" d x 42 1/2" h XS28-CCLIIA-W
QSS-CCLIIA-W

Side chair
21" w x 24" d x 42 1/2" h XS28-CCLIIS-W
QSS-CCLIIS-W

MONTAUK

EXPRESS EAT



SHOWN IN CHARACTER CHERRY, HAZELNUT



a

a Montauk Trestle II Table

Wood: Character Cherry; Finish: Hazelnut
Rough Sawn, 20° Sheen, & Plank Top Standard.

42" w x 72" l



XK02DS-ETMOK-I01D16Q 

QSK-ETMOK-I01D16Q 

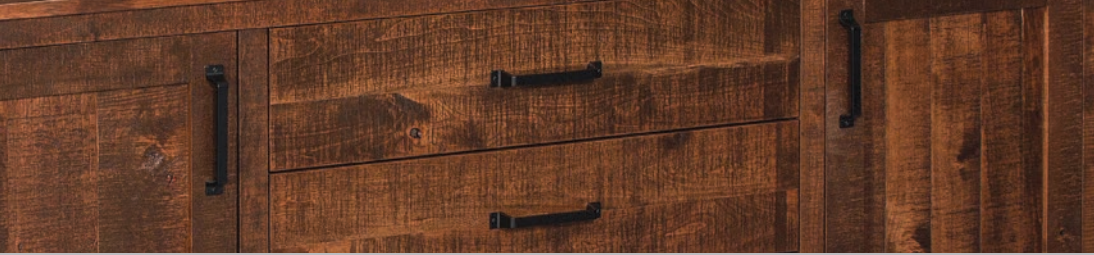
18" stationary butterfly leaves on each end.



Flat Black Pull
68-C-11

	
Character Cherry & QSWO Sides/Bases Open Knots Standard	Character Cherry & QSWO Table Tops Filled Knots Standard Case Goods Tops Filled Knots Standard Chair Seats Filled Knots Standard



a





b



c

a Montauk Buffet



Wood: Character Cherry; Finish: Hazelnut
Rough Sawn, 20° Sheen, & Plank Top Standard



60" w x 18 3/4" d x 36" h **XK02DS-ESMOK-G27C** 
QSK-ESMOK-G27C 

Features two adjustable shelves on each side.

b Montauk Chair

Wood: Character Cherry; Finish: Hazelnut
Olde World Level B & 20° Sheen Standard.

<u>Arm chair</u>	<u>Arm Height: 25" h</u>
24 1/2" w x 20 1/2" d x 39 1/2" h	XK02BS-ECMOK-01A-W 
	QSK-ECMOK-01A-W 

<u>Side chair</u>	
19" w x 20 1/2" d x 39 1/2" h	XK02BS-ECMOK-02A-W 
	QSK-ECMOK-02A-W 

c Montauk Trestle Dining Bench

Wood: Character Cherry; Finish: Hazelnut
Rough Sawn, 20° Sheen, & Plank Top Standard.

72" w x 17" d x 18" h **XK02DS-ECMOK-13D-W** 
QSK-ECMOK-13D-W 

SHEFFIELD

EXPRESS EAT



SHOWN IN SOFT MAPLE, SILVER CREEK



Rectangular Top

SATE-40
Small Roundover Edge

a



Boat-Shaped Top

SATE-40
Small Roundover Edge

b

a Sheffield Leg Table

Wood: Soft Maple; 38" w x 54" l

- Silver Creek XS56-ETSHE-J01K27B
- Bourbon XS28-ETSHE-J01K27B
- Bourbon-OW-A XS28A2-ETSHE-J01K27B
- QSS-ETSHE-J01K27B

Features one 18" leaf; $\frac{13}{16}$ " thick top.

b Sheffield Boat Table

Wood: Soft Maple; 42" w x 60" l

- Silver Creek XS56-ETSHE-J01K14B
- Bourbon XS28-ETSHE-J01K14B
- Bourbon-OW-A XS28A2-ETSHE-J01K14B
- QSS-ETSHE-J01K14B

Features one 18" leaf; $\frac{13}{16}$ " thick top.



Brushed Pewter Pulls
82-B-01



Shown with Olde World Aging, Level B



SILVER CREEK



BOURBON



BOURBON OW-B



b



c



d



e



f

a Sheffield 2-Door Sideboard

Wood: Soft Maple; 46" w x 18" d x 37 3/4" h

Silver Creek	XS56-ESSHE-D18	⇒
Bourbon	XS28-ESSHE-D18	⇒
Bourbon-OW-B	XS28B-ESSHE-D18	⇒
	QSS-ESSHE-D18	⇒

b Sheffield Dining Bench

Wood: Soft Maple; 45" w x 14" d x 18" h

Silver Creek	XS56-ECSHE-16I-W	⇒
Bourbon	XS28-ECSHE-16I-W	⇒
Bourbon-OW-B	XS28B-ECSHE-16I-W	⇒
	QSS-ECSHE-16I-W	⇒

c Sheffield Side Chair

Wood: Soft Maple; 18 3/4" w x 22 1/4" d x 38" h

Silver Creek	XS56-SPSHS-W	⇒
Bourbon	XS28-SPSHS-W	⇒
Bourbon-OW-B	XS28B2-SPSHS-W	⇒
	QSS-SPSHS-W	⇒

d Clifton Side Chair

Wood: Soft Maple; 18" w x 21 1/2" d x 39 1/2" h

Silver Creek	XS56-ECCLI-02A-W	⇒
Bourbon	XS28-ECCLI-02A-W	⇒
Bourbon-OW-B	XS28B2-ECCLI-02A-W	⇒
	QSS-ECCLI-02A-W	⇒

e Mitchell Side Chair

Wood: Soft Maple; 19" w x 21" d x 38 3/4" h

Silver Creek	XS56-ECMIT-02A-W	⇒
Bourbon	XS28-ECMIT-02A-W	⇒
Bourbon-OW-B	XS28B2-ECMIT-02A-W	⇒
	QSS-ECMIT-02A-W	⇒

f Waveland Side Chair

Wood: Soft Maple; 19" w x 21" d x 38 3/4" h

Silver Creek	XS56-ECWAV-02A-W	⇒
Bourbon	XS28-ECWAV-02A-W	⇒
Bourbon-OW-B	XS28B2-ECWAV-02A-W	⇒
	QSS-ECWAV-02A-W	⇒

ASPEN

EXPRESS EAT



SHOWN IN CHERRY, MICHAEL'S



SATE-60
Large Bevel



a



b



c



a Aspen Trestle Table with Inlay



Wood: Cherry; Finish: Michael's
1" thick top – standard.



48" w x 80" d XC26-MSA4880-4 
 QSC-MSA4880-4 

Features four 11½" self-storing leaves (no aprons), boat-shaped top, SATE-60 edge, and ball bearing slides.

b Aspen Chair with Inlay



Wood: Cherry; Finish: Michael's



Arm chair Arm height: 26" h
25¼" w x 21½" d x 48½" h
XC26-SAAA-W 
QSC-SAAA-W 

Side chair
18½" w x 21½" d x 48½" h
XC26-SAAS-W 
QSC-SAAS-W 

c Aspen Chair with Lower Back, Inlay, and Asphalt Leather Seat

Wood: Cherry; Finish: Michael's

Arm chair Arm height: 26" h
25¼" w x 21½" d x 43½" h
XC26-SAAA-5-LD 
QSC-SAAA-5-LD 

Side chair
18½" w x 21½" d x 43½" h
XC26-SAAS-5-LD 
QSC-SAAS-5-LD 

AUBURN BAY

EXPRESS EAT



SHOWN IN SOFT MAPLE, HAZELNUT



a



b

a Auburn Bay Trestle Table

2½" Edge Profile.

42" w x 84" l

XS02-ETABR-H01D17A

QSS-ETABR-H01D17A

b Auburn Bay Bench

2" Edge Profile.

72" w x 16" d x 18" h

XS02-ECABR-12D-W

QSS-ECABR-12D-W

EXPRESS

EAT

ALBANY

EXPRESS EAT



SHOWN IN OAK, MICHAEL'S



a

SATE-10
Large Roundover Edge



b

SATE-10
Large Roundover Edge



c



d

a Albany Round Table

Wood: Oak; Finish: Michael's
1" thick top – standard.

48" X026-ETALB-F06D22C
QSO-ETALB-F06D22C

Features two 12" leaves & Small Roundover edge (SATE-40).

b Square-Tapered Leg Table

Wood: Oak; Finish: Michael's
13/16" thick top – standard.

40" x 60" X026-ETSQT-J04A07C
QSO-ETSQT-J04A07C

Features two 12" leaves, Square-Tapered legs, 1" Radius corners, Large Roundover edge (SATE-10).

c Justine Chair

Wood: Oak; Finish: Michael's

Arm chair Arm height: 25" h
23" w x 22" d x 40" h X026-KSJAC-W
QSO-KSJAC-W

Side chair
19" w x 22" d x 40" h X026-KSJSC-W
QSO-KSJSC-W

d Urbandale II Chair

Wood: Oak; Finish: Michael's

Arm chair Arm height: 25 3/4" h
24" w x 24" d x 42" h X026-KSUIIAC-W
QSO-KSUIIAC-W

Side chair
19" w x 24" d x 42" h X026-KSUIISC-W
QSO-KSUIISC-W

PARKDALE

EXPRESS EAT



SHOWN IN SOFT MAPLE, HAZELNUT



a



b



c



d



e

a Parkdale Single Pedestal Table

Wood: Soft Maple; Finish: Hazelnut
1" thick top – standard.

48" round XS02-ETPAR-E06D220
QSS-ETPAR-E06D220

Features one 18" butterfly leaf.

b Bradford Chair

Wood: Soft Maple; Finish: Hazelnut

Arm chair Arm Height: 25¼" h
23¾" w x 23¼" d x 40" h

XS02-ECBRD-01A-W
QSS-ECBRD-01A-W

Side chair

18½" w x 23¼" d x 40" h
XS02-ECBRD-02A
QSS-ECBRD-02A

c Claire Chair, Flint

Wood: Soft Maple; Finish: Mocha Nut

19" w x 27" d x 40" h XS30-ECCLR-02A-FLINT

d Claire Chair, Linen

Wood: Soft Maple; Finish: Mocha Nut

19" w x 27" d x 40" h XS30-ECCLR-02A-LINEN

e Claire Chair, Pewter

Wood: Soft Maple; Finish: Mocha Nut

19" w x 27" d x 40" h XS30-ECCLR-02A-PEWTE

Express – Available immediately in the listed wood/finish.
 QuickShip – Available in reduced time. Select your finish.

simplyamish

Available in Advantage Fabric

EAT

471

EXPRESS

EAT

EXPRESS

Small Roundover Edges

LIVE



SHOWN IN SOFT MAPLE, RAWHIDE



a





b

Knots on top are filled - standard.

a Justine TV Stand with Soundbar Shelf, Large

Wood: Soft Maple; Finish: Rawhide
 62" w x 19" d x 32½" h XS49-LEJUS-L40C 
 Features open space behind each door.
 Openings - Top: 55½" w x 17¾" d x 5" h;
 Center: 19" w x 17¾" d x 16½" h; Door: 16¾" w x 17¾" d x 16½" h

b Shenandoah TV Console with Wood Doors and Open Center

Wood: Character Cherry; Finish: Michael's
 60" w x 18" d x 28½" h XK26-LESHS-C41C 
 QSK-LESHS-C41C 
 Features adjustable shelf behind each door.
 Center: 20" w x 16" d x 19½" h; Door: 15" w x 16" d x 19¾" h



Fully Open



Back Side



b



c

a Greenville Incognito Coffee Table

Wood: Character Cherry; Finish: Hazelnut
 54" w x 30" d x 18" h XK02-LOGRE-25C4A 
 QSK-LOGRE-25C4A 

Features a lift top, two lifting drawers, three secret push-to-open drawers, and one secret push-to-open compartment. Rough Sawn Standard.

b Parkdale Round Coffee Table with Shelf

Wood: Soft Maple
 41 3/4" dia. x 18 1/4" h QSS-LOPAR-23A1A 
 Features 1 1/4" thick top.

c Parkdale Round End Table with Shelf

Wood: Soft Maple
 22" dia. x 24 1/4" h QSS-LOPAR-26A4A 
 Features 1 1/4" thick top.



a



b



c



d



e



f



g





h

a Aaralyn Sofa Table 
 Wood: Cherry; Finish: Michael's
 36" w x 13" d x 27" h XC26-LWAST

c Aaralyn End Table 
 Wood: Cherry; Finish: Michael's
 18" w x 22" d x 22" h XC26-LWAET

e Grace Sofa Table 
 Wood: Cherry; Finish: Bourbon
 36" w x 13" d x 27" h XC28-LWGST

g Grace End Table 
 Wood: Cherry; Finish: Bourbon
 18" w x 22" d x 22" h XC28-LWGET

b Aaralyn Coffee Table 
 Wood: Cherry; Finish: Michael's
 36" w x 18" d x 18" h XC26-LWA1836CT
 42" w x 22" d x 18" h XC26-LWA2242CT

d Aaralyn Lamp Table 
 Wood: Cherry; Finish: Michael's
 17" w x 13" d x 27" h XC26-LWALT

f Grace Coffee Table 
 Wood: Cherry; Finish: Bourbon
 36" w x 18" d x 18" h XC28-LWG1836CT
 42" w x 22" d x 18" h XC28-LWG2242CT

h Grace Lamp Table 
 Wood: Cherry; Finish: Bourbon
 13" w x 17" d x 27" h XC28-LWGLT



a



b



c



d



e



f



g



h

a Marshall Sofa Table 

Wood: Quartersawn; Finish: Michael's
36" w x 13" d x 27" h XQ26-LWMST

b Marshall Coffee Table 

Wood: Quartersawn; Finish: Michael's
36" w x 18" d x 18" h XQ26-LWM1836CT
42" w x 22" d x 18" h XQ26-LWM2242CT

c Marshall End Table 

Wood: Quartersawn; Finish: Michael's
18" w x 22" d x 22" h XQ26-LWMET

d Marshall Lamp Table 

Wood: Quartersawn; Finish: Michael's
13" w x 17" d x 27" h XQ26-LWMLT

e McCoy Cabinet Sofa Table 

Wood: Quartersawn; Finish: Michael's
48" w x 16" d x 29½" h XQ26-MAMC1648
Features one fixed shelf.

f McCoy Cabinet Coffee Table 

Wood: Quartersawn; Finish: Michael's
42" w x 22" d x 18" h XQ26-MAMC2242
Features open space behind doors.

g McCoy Cabinet End Table 

Wood: Quartersawn; Finish: Michael's
20" w x 22" d x 24" h XQ26-MAMC2022
Features open space behind door.

h Raised Panel Storage Bench

Wood: Oak; Finish: Gold Dust
Features large storage area under seat.
44" w x 20" d x 22" h XQ01-SBWR-W 
QSO-SBWR-W 



a Grand Rapids Recliner

Wood: Quartersawn; Finish: Michael's; Copper Leather
 32¼" w x 38" d x 39½" h XQ26-AJHLR-LD

b Aspen Recliner with Inlay

Wood: Cherry; Finish: Michael's
 Asphalt Leather
 32½" w x 38" d x 39½" h XC26-AJAR-LD

c Urbandale II Arm Glider

Wood: Oak; Finish: Michael's; Tigers Eye Leather
 24" w x 39" h Seat: 17½" h X026-KSUIIG-LD
 QSO-KSUIIG-LD

d Urbandale Glider Ottoman

Wood: Oak; Finish: Michael's; Tigers Eye Leather
 21" w x 21" d x 15" h X026-KSUGO-LD
 QSO-KSUGO-LD

e Big Daisy Rocker

Wood: Oak; Finish: Gold Dust
 26" w x 32" d x 42" h X001-KSBDR-W
 QSO-KSBDR-W

f Urbandale II Arm Rocker

Wood: Oak; Finish: Michael's
 24" w x 39" h Seat: 17½" h X026-KSUIAR-W
 QSO-KSUIAR-W



a



b



c



d



e



f

a Bentwood Rocker 

22" w x 29" d x 41" h

Oak

Cherry

QSO-AP8001BOR

QSC-AP8001BOR

b Cherry Hollow Bentwood Rocker 

25" w x 32" d x 42" h

Between arms: 19½"

Features Hickory Saplings and Cherry back, seat, & rockers. Finish: Michael's

X-EPRCR

c Cherry Hollow Bentwood Jumbo Rocker 

28" w x 32" d x 44" h

Between arms: 22½"; Seat is 2" taller

Features Hickory Saplings and Cherry back, seat & rockers. Finish: Michael's

X-EPRCR-J

d Hickory Hollow Bentwood Rocker 

25" w x 32" d x 42" h

Between arms: 19½"

Features Hickory Saplings and Hickory back, seat, & rockers. Finish: Natural

X-EPRHR

e Hickory Rocker with Cherry and Walnut Slats 

25" w x 32" d x 42" h

Between arms: 19½"

Features Hickory Saplings and Cherry/Walnut mixture back, seat & rockers. Finish: Natural

X-EP102HRCW

f Hickory Rocker with Oak Slats, Regular 

25" w x 32" d x 42" h

Between arms: 19½"

Features Hickory Saplings and Oak back, seat, & rockers. Finish: Natural

X-EP100HRO

EXPRESS

Small Roundover Edges

WORK



SHOWN IN QUARTERSAWN WHITE OAK, MICHAEL'S



a



b



c



d

a Prairie Mission Arm Desk Chair

Wood: Quartersawn; Finish: Michael's
Features Copper leather seat and gas lift.
26" w x 20" d XQ26-LFSADC-LD ➡

b Prairie Mission Large Writing Desk

Wood: Quartersawn; Finish: Michael's
64" w x 30" d x 30" h XQ26-TVPMD3064 ➡
Features a convertible drawer and 2 small pencil drawers.

c Loft Arm Desk Chair

Wood: Character Cherry;
Finish: Olde World Fruitwood, No Wax (Level B2)
22½" w x 25½" d XK32B2-SALOADC-LF ➡
Features SANORF-9J0179 Molasses leather seat and gas lift.

d Aspen Writing Desk with Inlay

Wood: Character Cherry; Finish: Olde World;
Finish (Top): Fruitwood-A1; Finish (Rest):
Oatmeal-A1
60" w x 30" d x 30" h XK2T-WDASP-04B1 ➡
Knee Area: 47" w x 23½" h
Features a convertible drawer.

➡ Express – Available immediately in the listed wood/finish.

BEAUTIFUL, NATURAL, AUTHENTIC, GENUINE, ORIGINAL, UNIQUE
AMERICAN, HAND-CRAFTED, CUSTOM-BUILT, DURABLE, STRONG
TOUGH, HARDY, SOUND, GRACEFUL, STOUT, STEADY, POWERFUL
PERSONAL, PRAGMATIC, USEFUL, LOVEABLE, WELL-BUILT, STURDY
WELL-CONSTRUCTED, DOWNTOWN, RELIABLE, CASUAL, ROBUST
RESPLENDENT, REMARKABLE, LIVEABLE, DEPENDABLE, MODERN
ELEGANT, REFINED, DRAMATIC, DISTINGUISHED, SOLID, CLEVER
COMFORTABLE, COZY, EASY, CONTEMPORARY, CONSERVATIVE
MODERN, TRADITIONAL, RELAXED, POLISHED, HOMEY, CURRENT
COMPELLING, CHARMING, PRACTICAL, DISARMING, INVITING
ENTICING, MOVING, UPTOWN, INSPIRED
STRIKING, INTENSE, SIMPLY URBAN, RUGGED
REAL, ALL-AROUND, USEFUL, ENVIED
SMART, UNEXPECTED, UNCOMPLICATED, UNCOMPROMISING
UNPRETENTIOUS, WELL-DESIGNED, EYE-CATCHING, IMPRESSIVE
STYLISH, POSH, GRAND, REGAL, WELCOMING, SIMPLE, BEAUTIFUL
NATURAL, AUTHENTIC, GENUINE, ORIGINAL, UNIQUE, AMERICAN
HAND-CRAFTED, GRAND, DURABLE, STRONG, TOUGH, HARDY
ROBUST, SOUND, SOLID, STOUT, STURDY, STEADY, POWERFUL
PRACTICAL, PERSONAL, PRAGMATIC, SMART, LOVEABLE, MODERN
WELL-BUILT, KID-FRIENDLY, RUGGED, RELIABLE, RESPLENDENT
REMARKABLE, WELL-CONSTRUCTED, DEPENDABLE, ELEGANT
REFINED, DRAMATIC, DISTINGUISHED, INSPIRED, CASUAL, CLEVER
COMFORTABLE, COZY, EASY, DISARMING, LIVEABLE, DOWNTOWN
REAL, ALL-AROUND, CAREFREE, ADMIRER, RELIABLE, ENVIED
UNEXPECTED, LOVELY, UNCOMPLICATED, UNCOMPROMISING
RELIABLE, CUSTOM-BUILT, REGAL, WELCOMING, SIMPLE, AMISH

2020-21 SIMPLY AMISH CATALOG

SINCE 1979

WWW.SIMPLYAMISH.COM

MANY STYLES. ONE STANDARD.

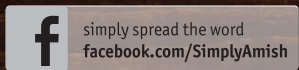

© Copyright 2021 Simply Amish

JULY 2021